

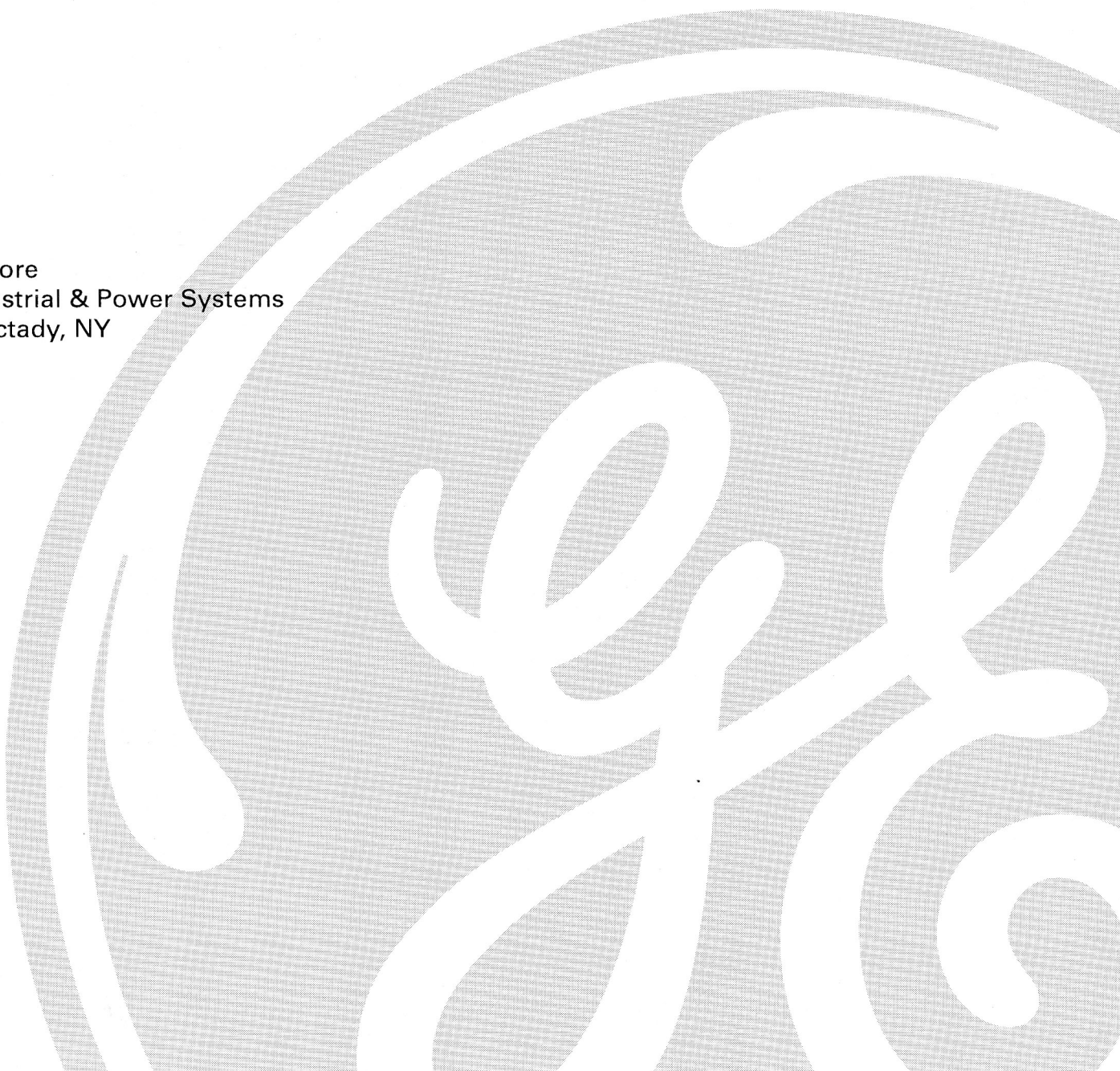

GE Power Systems

High-Power-Density™ Steam Turbine Design Evolution

J.H. Moore
GE Industrial & Power Systems
Schenectady, NY



HIGH-POWER-DENSITY™ STEAM TURBINE DESIGN EVOLUTION

J. H. Moore
GE Industrial & Power Systems
Schenectady, NY

INTRODUCTION

The maximum rating of new power plants has increased continuously since the earliest days of the electric power industry, reducing the cost of power through the economies of scale of large plants. Supporting this trend has required the continuous development of turbine-generator technology to produce larger ratings and increased power density. Power density is a measure of the compactness of a turbine-generator. Increases are achieved through advances in engineering and materials technologies that permit reductions in the size and weight of a machine required for a given electrical output, thereby reducing the cost of the turbine-generator, foundation, and building. The technology of High-Power-Density™ steam turbine design is applied today, not just for the purpose of producing units of the largest rating, but also for reliable, cost-effective turbine-generators over a wide range of ratings and for combined-cycle as well as fossil-fueled plant applications.

Significant increases in the maximum turbine-generator rating and in power density were achieved in the first fifty years with increases in steam temperature and pressure and the introduction of regenerative feedwater heating and reheat steam cycles. Since the 1950s, supercritical steam pressures have been employed at the largest ratings. Modest increases in steam temperatures above 1000F (538C) and a second reheat have had some application, but the major increases in power density over the last forty years have been achieved primarily in the following three ways.

Larger Tandem-Compound Designs

Traditionally, increases in the maximum rating of new power plants have been achieved initially with a cross-compound, turbine-generator design, primarily because of limitations in maximum generator rating. Cross-compound units have two separate shafts, in a few instances, three, which drive separate half-sized generators, but operate as a single unit. As advances in generator technology make larger generator ratings available, more cost-effective, tandem-compound designs become the choice.

Today, full-speed, tandem-compound designs for fossil-fueled plants are available to approximately 1100 MW.

Full-Speed Designs

Very large volume flow requires large physical size for the turbine steam path, which can be achieved with multiple parallel flows or with half-speed designs. Designing for half-speed operation permits the diameters of rotating components to increase by a factor of two and flow area by a factor of four without increasing the level of stresses imposed by centrifugal forces. Both the turbine and generator are significantly larger and more expensive than for full-speed designs, however. Through the 1940s, many large nonreheat machines were built for half-speed operation. With more modern designs, use of reheat has permitted higher inlet pressure, which reduces the required volume flow. Today, the very largest turbines for fossil plants have full-speed high-pressure and intermediate-pressure sections, and applications for half-speed designs are limited to low-pressure rotors of the very largest cross-compound units. The steam from water-cooled nuclear reactors is at low pressure and temperature and, therefore, very large volume flows are required for large ratings. Consequently, the largest nuclear units are designed for half-speed operation.

Reduction in Number of Turbine Casings

For full-speed, tandem-compound turbines, the elimination of an entire casing is achieved in one of two ways. In the low-pressure section, the number of exhaust flows required is determined by the length of the longest last-stage bucket available. Tandem-compound units have been built with one, two, three, four, and six exhaust flows. In modern practice a single exhaust flow, or one, two, or three double-flow exhaust sections are used. The development of last-stage buckets of increasing length has permitted significant increases in the power density of today's units by reducing the number of exhaust sections required for a given rating.

At the high-pressure end of the machine, steam volume flow is smaller, and except for first stages

with partial-arc admission, a single-flow section is almost always used. Designs that combine the high-pressure section with a single-flow intermediate-pressure section in a single casing eliminate the need for a separate intermediate-pressure turbine section. Combined HP/IP designs have been used extensively by GE to achieve high power density.

DEVELOPMENT OF LONG LAST-STAGE BUCKETS

Efficient turbine design requires that steam be expanded to very low pressure and exhaust with low kinetic energy. This requires large exhaust annulus area. The earliest steam turbines were built, as are small units today, with a single exhaust flow. Historically, ratings have increased at a faster rate than the development of longer last-stage buckets, leading to the use in tandem-compound turbines of two, three, four, and six parallel exhaust flows in multiple sections.

The evolutionary development of longer last-stage buckets has played a crucial role in the increase in steam turbine maximum ratings and power density. For 3600 rpm units, GE introduced a 20-inch (508 mm) last-stage bucket in 1940, followed by buckets of length 23 inches (584 mm) in 1948, 26 inches (660 mm) in 1954, 30 inches (762 mm) in 1962, 33.5 inches (851 mm) in 1967, and a titanium 40-inch (1016 mm) design in the mid-1980s. The introduction of longer last-stage buckets for 3000 rpm application generally paralleled that for 3600 rpm, with the longest steel bucket of 42 inches (1067 mm), derived from the 3600 rpm, 33.5-inch (851 mm) bucket by scaling, introduced in 1992. A 3000 rpm titanium bucket of 48 inches (1219 mm) in length, derived from the 40-inch (1016 mm) 3600 rpm bucket by scaling, is available today. Both the 3000 rpm and 3600 rpm families of last-stage buckets provide for selection of exhaust annulus in increments of approximately 25%. The use of titanium for the 40-inch (1016 mm) and 48-inch (1219 mm) buckets results from studies in the early 1980s, which concluded that continued development of longer buckets beyond the 33.5-inch (851 mm) and 42-inch (1067 mm) would require titanium to achieve acceptable stress levels in both rotor and buckets. Following basic material and productibility development, 33.5-inch (851 mm) titanium buckets were placed in service on a selective basis to gain operating experience in advance of introducing new longer buckets of titanium.

The traditional practice of turbine-generator manufacturers through the 1950s, was to design long buckets, with or without covers, with one or more tie wires (lashing wires) that pass through holes in the buckets at mid-vane or near the tip, coupling groups of buckets together and providing vibration damping. It was recognized at that time that further increases in bucket length would involve higher tip velocities and higher vane stress levels, and that a different approach would be required if high performance and reliability were to be achieved. Longer buckets developed since that time have been primarily of either free-standing or continuously-coupled design, two very different approaches to the development of longer last-stage buckets.

Free-standing buckets have no connections between buckets, either at mid-vane or at the tip. They, therefore, have very low mechanical damping and must be designed with a high degree of rigidity. The rigidity is achieved by using a massive vane width at the root and a high degree of tapering from root to tip. This results in relatively few vanes with free-standing designs, typically about half as many per row as with coupled designs.

GE introduced the first continuously-coupled design for long buckets in 1967 (Figure 1). The row is continuously-coupled 360 degrees around the wheel, using covers at the tips and sleeves near the bucket midpoint. The connections are designed to provide freedom for circumferential growth and bucket untwist due to centrifugal loading, while still maintaining an efficient bucket-to-bucket flow passage. Structurally, the cover and sleeve connections provide for rigidity, modal suppression, and damping, permitting the use of relatively thin vane sections and more passages per row.

From the standpoint of aerodynamic efficiency, it has long been recognized that a large number of slender buckets per row is superior to the use of a few massive vanes. A small number of highly-tapered vanes results in low solidity, or poor relationship between the spacing between vanes and the size of the vane at the tip. This is of increasing importance as buckets become longer and flow velocities increase. For the longer, modern last-stage buckets, the flows are supersonic, and the contours of adjacent sides of supersonic passages are of critical importance in avoiding large shock losses. Figure 2 shows a comparison of a low-solidity bucket tip section with the supersonic tip section of a coupled last-stage bucket design. Successful applications of this supersonic converging-diverging flow

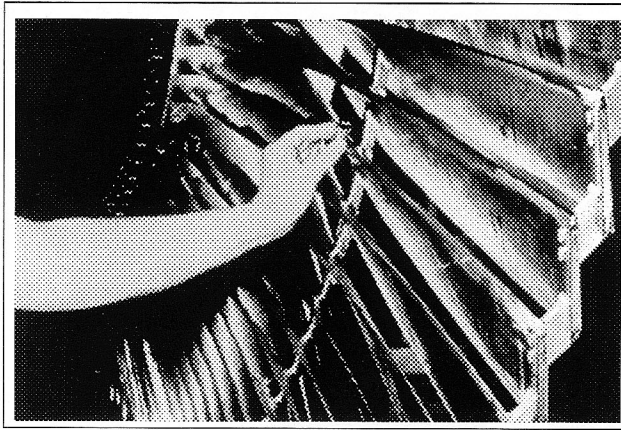

GT20488

Figure 1. Continuously-coupled last-stage buckets

passage design require that the profile tolerances be strictly maintained during manufacture and operation. Bucket covers secure the tip and help meet this requirement.

Covers are also beneficial in providing a means of sealing with spill strips to reduce tip leakage losses. Also, an uncovered design allows flow to migrate from the high-pressure to the low-pressure side of the bucket over the tip, increasing the secondary flow loss by contributing to a disorganized flow pattern in this region. A cover effectively isolates the flow in each passage from the stationary components and minimizes this effect (Figure 3).

The vane midpoint connections in coupled designs provide some obstruction to the steam flow and cause a loss in efficiency. This effect is minimized by locating these connections away from the high velocity region and aerodynamically shaping the connections. The resulting loss is outweighed by

the improvements resulting from using bucket covers and tip spill strips, more buckets per row, and buckets with a more nearly optimum solidity.

Following successful testing and operational experience with the first continuously-coupled design, all GE 3000 rpm and 3600 rpm last-stage buckets for utility and combined-cycle applications were redesigned to incorporate continuous-coupling and modern aerodynamic vane contours.

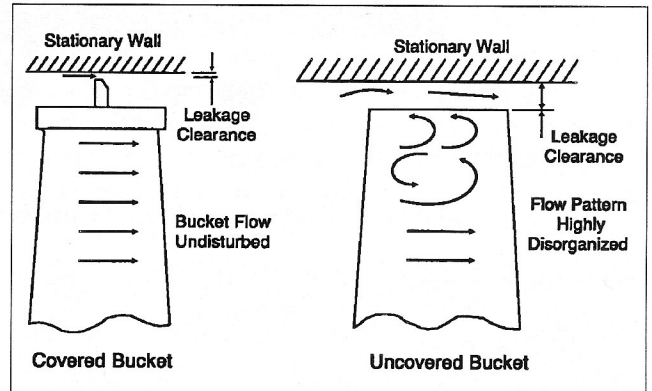

GT20.484A

Figure 3. Leakage-loss and flow-disturbance reduction with tip cover

COMBINED HIGH-PRESSURE/ INTERMEDIATE-PRESSURE OPPOSED-FLOW TURBINE DESIGN

The single-span, combined high-pressure/intermediate-pressure opposed-flow design was invented and developed by GE and first placed in service in an 80 MW unit in 1950 (Figure 4). By the end of the 1950s, 192 units with this feature were in opera-

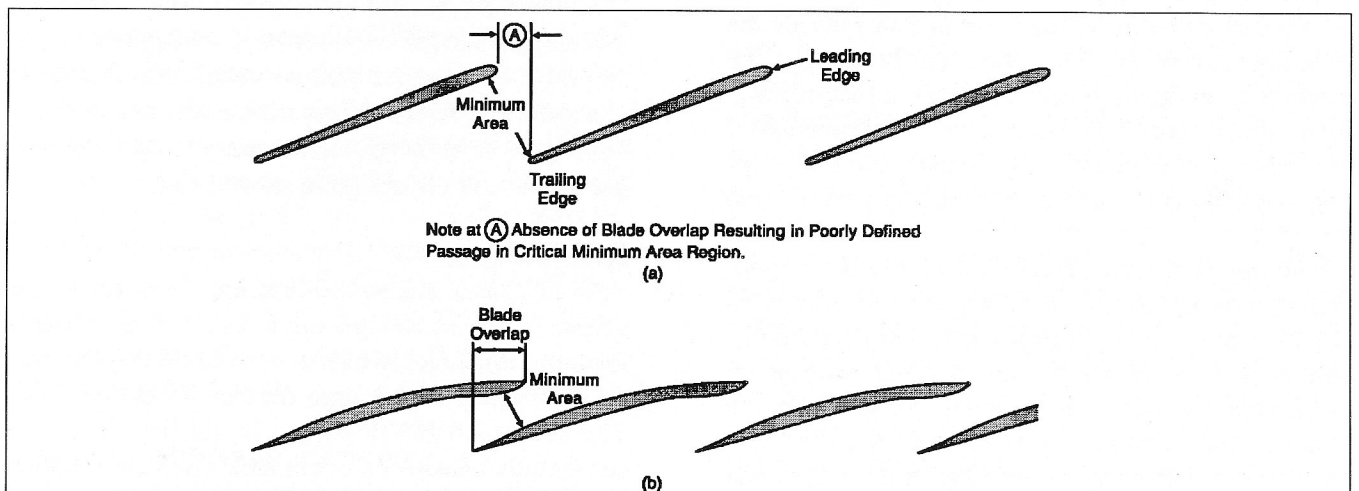

GT20486A

**Figure 2. (a) Typical LSB tip section with low solidity;
(b) Typical high-solidity supersonic tip section with coupled LSB design**

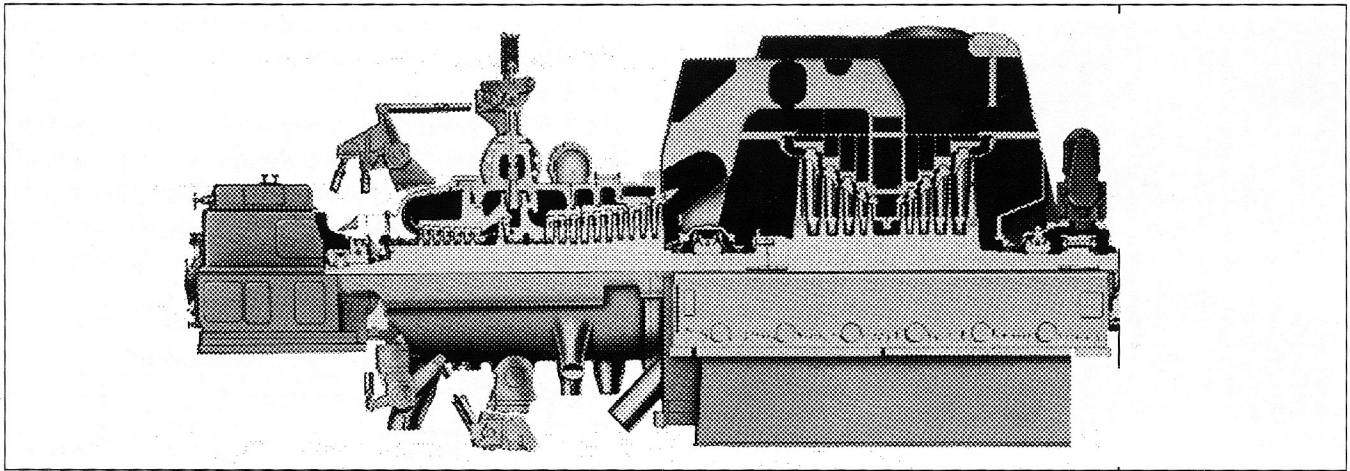

TC1087649

Figure 4. First application of combined HP/IP section on 80 MW steam turbine

tion with the largest rated at 260 MW. Today, there are over 500 GE turbines with opposed-flow design in operation. The largest, rated 738 MW, are double-reheat designs, the first of which went into service in 1969. GE licensees and business associates around the world have produced many additional units using the same technology.

Opposed-flow HP/IP turbine construction is predominant in the United States and other countries including Japan, France, Korea, and Taiwan with large fleets of impulse turbines having wheel-and-diaphragm construction. It has been less frequently applied in markets primarily served by manufacturers of reaction turbines. The use of impulse turbine technology leads to smaller rotor diameters, fewer stages, and shorter bearing spans, and is, therefore, better suited to the more compact design in large ratings.

The compact design of the opposed-flow section eliminates an entire turbine casing and reduces the size and cost of the foundation and building. The savings in installation time and cost are significant. Maintenance costs are reduced by the elimination of one casing. Investment in spare parts such as packing rings, bearings, and rotor coupling parts is also reduced.

The opposed-flow design is a highly-developed, versatile design that has been successfully applied in a wide variety of applications and steam conditions. Although most plants are single reheat with equal rated temperatures for throttle and reheat steam, the opposed-flow design is also applied with the high-pressure and first-reheat section in double-reheat applications, and with a 25F (14C) or 50F (28C) difference between rated throttle and reheat temperature.

High-pressure steam enters the center of the combined HP/IP turbine section and flows toward one end, while steam from the reheater at a similar temperature also enters near the center and flows toward the other end of the section. This arrangement confines the highest temperature steam to a single central location and results in an even temperature gradient from the center toward the ends, with the coolest steam adjacent to the end packings and bearings. Tests have shown that this leads to a lower rate of temperature decay after overnight and weekend shutdowns, permitting more rapid restarting. Avoiding high-temperature steam at both ends of the section minimizes the energy loss associated with packing leakage flows.

Some manufacturers have not developed the technology of combining the HP and IP sections in large ratings, preferring to use two separate casings in all but their smallest units. This could suggest the view that the combined HP/IP design, being more compact, must be more highly stressed and, therefore, compromised in reliability, efficiency, or operating flexibility. It is, therefore, necessary to consider various aspects of the design in some detail.

Reliability

All GE large steam turbines are designed to the same system of design rules, allowable stresses, loading limits, etc., which are based on the successful experience of the large fleet of in-service units. The combined HP/IP design is not based on less conservative design practices and is not less reliable. In fact, industry reliability statistics on the entire fleet of GE utility-size turbines operating in the

United States indicate a small but consistent advantage in reliability for the opposed-flow design over a design having separate sections at the same rating. This advantage is the result of having one less rotor and casing and fewer components such as bearings, couplings, and packings, and it confirms the fact that the greater compactness is not achieved with less conservatism in the design.

Efficiency

A number of differences between the combined HP/IP design and the separate-casing design have some impact, either positive or negative, on thermodynamic performance. The opposed-flow design benefits from lower bearing losses, having a smaller thrust bearing and two journal bearings instead of four. The opposed-flow design has lower packing leakage losses, having only two shaft-end packings and one mid-span packing compared to four shaft-end packings for the separate-casing design. Furthermore, the separate-casing design has at least one shaft-end packing with high-temperature, high-energy steam leakage, whereas the opposed-flow design does not. When the basis for comparison is a separate-casing design with a double-flow IP section, there is also an efficiency advantage for the single-flow IP of the opposed-flow design due to the improved volume flow effect of the longer buckets. On the other hand, the rotor for the opposed-flow design has a larger bearing span and larger diameter than either the HP or IP rotor of the separate-casing design and, therefore, has somewhat greater stage leakage flows.

When all of these factors are taken into account, the net difference in efficiency between the opposed-flow design and the separate-casing design is essentially zero at all ratings. This is true both for the initial efficiency of a new unit and the long-term performance of turbines in operation. It is important to note that this comparison is made between two turbines of GE design with wheel-and-diaphragm construction. The result may not be the same for reaction turbine designs with large diameter drum-type rotors. A major advantage of wheel-and-diaphragm construction is that stage sealing diameters are inherently smaller than is possible with drum-type rotor design.

Use of a Mid-Span Packing

The opposed-flow design requires a packing in the middle to separate the HP and IP sections. Leakage of steam from the HP to the IP, like any other pack-

ing leakage flow, represents a loss in performance. The net effect of all packing leakage losses is an advantage, not a disadvantage, for the opposed-flow design as has already been described. Nevertheless, the presence of the mid-span packing is sometimes cited as an undesirable feature, presumably because at mid-span the rotor diameter is greater than at the shaft-end packings, and at mid-span, the packing is more prone to rubbing-out from shaft vibration. This is not the experience, however. GE steam turbines have an excellent record of sustained performance. There are two reasons that probably account for the fact that excess leakage through the mid-span packing is not a significant problem. First, leakage flow from the mid-span packing is, by design, used to cool the first-reheat stage wheel on large machines. Therefore, the design clearance, being based on achieving the required cooling flow, is greater than it would otherwise be, reducing the likelihood of rubbing from shaft vibration. Second, while it is true that the rotor diameter is greater at the mid-span packing than at the shaft-end packings, it is generally less than that in a reaction turbine design having drum-type rotors.

Tolerance Against Thermal Distortion

Both the main and reheat steam piping connections are made at the middle of the combined HP/IP shell. The permissible temperature difference between inlets is a function of load, with a large difference permissible at low load, where boiler temperature control is likely to be most difficult, and a more restrictive limitation applicable at high load. Experience has been that operation within these limits is readily achieved with all types of boilers, including drum-type and once-through designs, for subcritical and supercritical pressures, of American and European design, and operated in either constant-pressure or sliding-pressure modes. There is no history of horizontal joint leakage, internal rubbing, or other problem due to shell distortion attributable to operation with an excessive difference between the temperature of the throttle and reheat steam with GE designs. This is due, in part, to the use of wheel-and-diaphragm construction, which has a higher degree of tolerance for thermal distortion than does the construction of reaction turbines with internal sealing devices supported directly from the inner shell. A fundamental advantage of the use of separate diaphragms supporting the inter-stage root and tip clearance control devices is that

they remain concentric with the rotor and maintain proper stage-packing clearances in the presence of considerable thermal distortion of the inner shell.

Bypass systems are sometimes used to improve boiler temperature control during start-up and may help to reduce the difference between main and reheat steam temperatures. Bypass system operation is fully compatible with opposed-flow designs, but not required to obtain satisfactory temperature matching.

Starting and Loading Capability

The starting and loading capability of any large steam turbine is limited primarily by thermal stresses in the HP and IP rotors. The major, although not the only, factor that determines the permissible temperature ramp rate for a given allowable thermal stress is diameter. Since the bearing span for the opposed-flow rotor is greater than that for either rotor of a turbine with separate HP and IP sections, the shaft diameter tends to be larger, when designed to have similar dynamic characteristics. This could be a disadvantage at the very largest ratings if the boiler and other plant equipment have a greater capability for rapid starting and loading, and if the unit will cycle frequently. When carefully studied, however, this is seldom found to be the case. In most cases the opposed-flow design with wheel-and-diaphragm construction will have starting and loading capability comparable to a drum-type design with separate high-pressure and reheat sections.

APPLICATION OF HIGH-POWER-DENSITY™ TURBINES

The application of longer last-stage buckets to reduce the number of low-pressure exhaust sections

required is applicable to all condensing-turbine applications. In fossil-fueled utility turbine applications with the long titanium buckets available today, a single double-flow section can be applied at up to about 700 MW depending on several variables, the most significant of which is condenser back pressure.

Steam turbines for combined-cycle particularly benefit from availability of long last-stage buckets because of the relatively high exhaust flow associated with steam cycles in heat recovery applications. The steam turbine in a typical fossil plant with extractions for feedwater heating has an exhaust flow that is seventy to eighty percent of throttle flow. In the most efficient heat-recovery applications, feedwater heating is performed in the heat-recovery steam generator, and instead of steam extractions, the turbine has one or two low-pressure steam admissions so that the exhaust flow is 120 to 130 percent of throttle flow. Combined-cycle steam turbines, therefore, require a very large exhaust annulus area.

A variety of combined HP/IP designs have been developed to suit specific applications. The configuration in Figure 5 is for a large utility turbine. Nozzle boxes at the HP inlets are required for partial-arc admission with supercritical steam pressure.

The design in Figure 6 is also for large utility application, but for sub-critical steam pressure. The HP inlet has a nozzle plate rather than nozzle boxes.

Figure 7 shows a design for reheat combined-cycle. The single-wall shell construction is applied with throttle pressure less than 1800 psi (12.41 MPa). This design has simplified shell geometry in the HP and reheat inlet regions and is suitable for daily start-and-stop and rapid-load-change operation, often required for combined-cycle. The design shown in Figure 8 has a short inner shell, providing

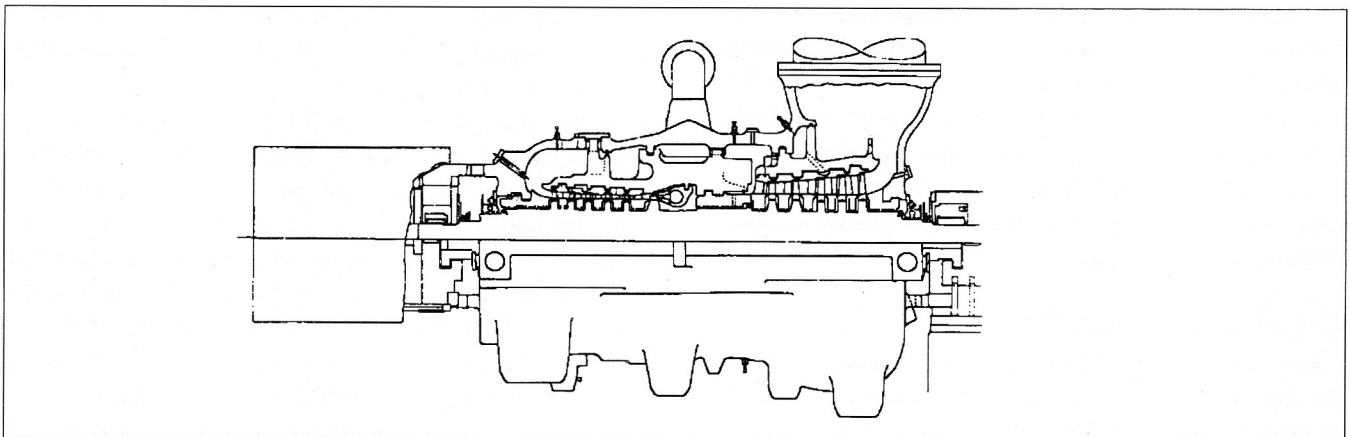
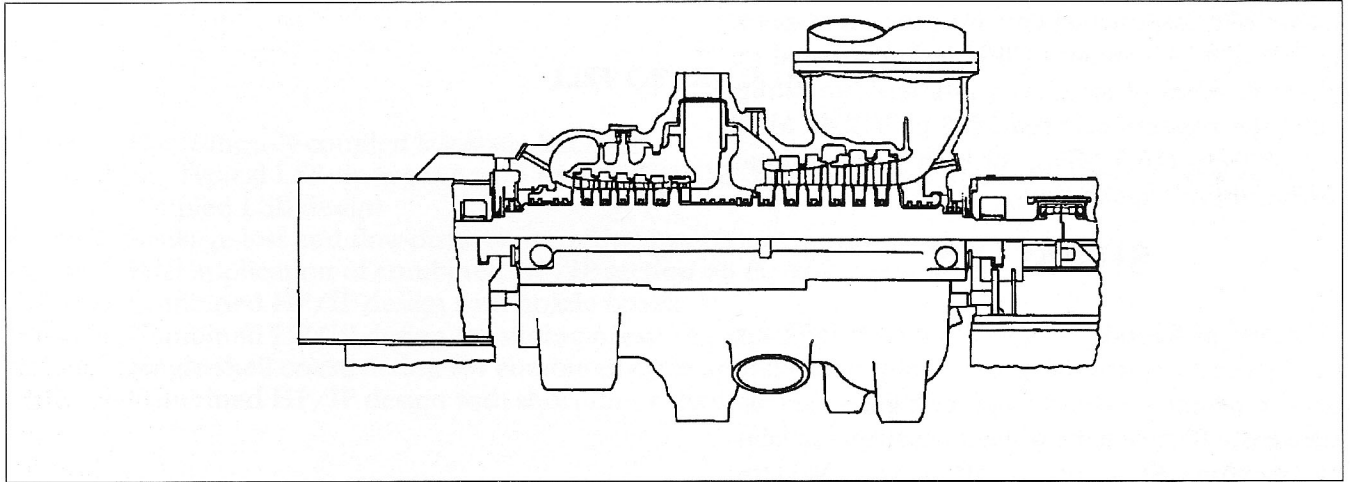

Figure 5. Combined HP/IP design with nozzle boxes

GT20,465



GT23,809A

Figure 6. Combined HP/IP design for 2400 psi (16.5 MPa) applications

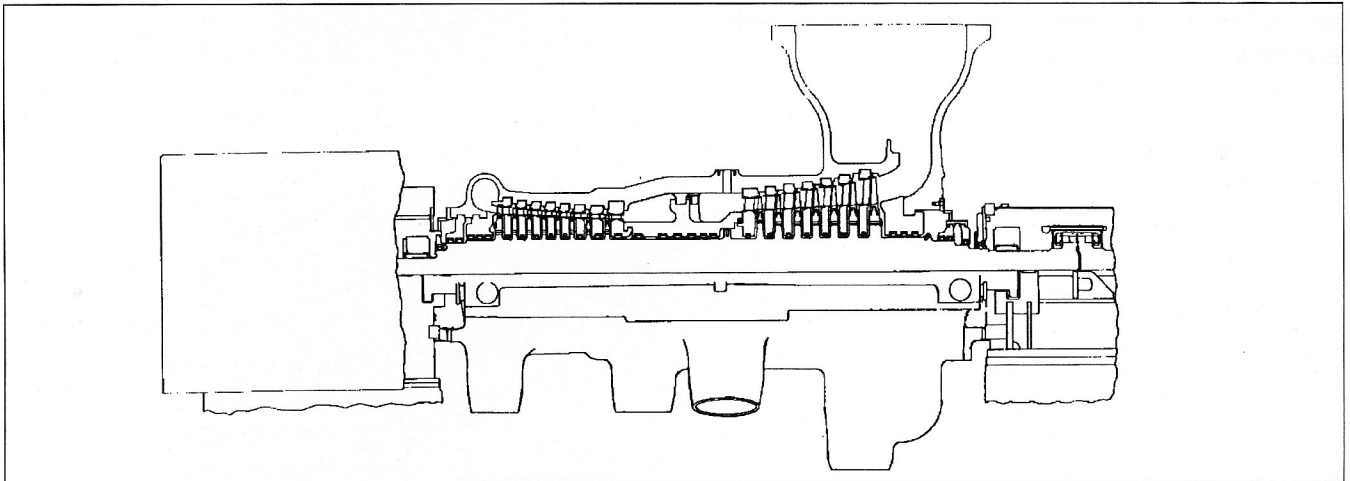

GT24,498

Figure 7. Single-shell construction for combined-cycle application

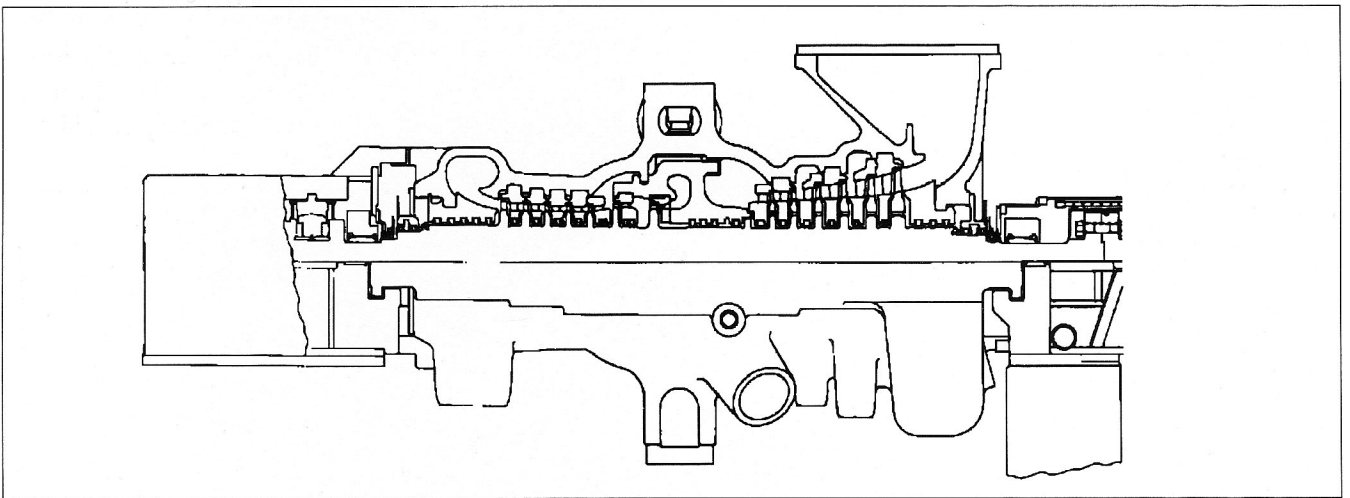

RDC27015-03

Figure 8. Combined HP/IP design with short inner shell

double-wall construction only over several stages at the HP inlet. Variations of this design are used for reheat turbines of small and intermediate rating, with inlet pressure between 1800 psi (12.41 MPa) and 2400 psi (16.5 MPa), for both fossil-fuel and combined-cycle applications.

SUMMARY

The designs for today's High-Power-Density™ turbine-generators have been developed over many years to permit the construction of higher-rated and more cost-effective units without penalizing reliability, operating flexibility, or efficiency. Modern, longer last-stage buckets that minimize the number of exhaust flows required and compact designs that combine the HP and IP sections into a single casing are applied in combined-cycle applications as well as in large utility machines.

LIST OF FIGURES

- Figure 1. Continuously-coupled last-stage buckets
- Figure 2. (a) Typical LSB tip section with low solidity; (b) typical high-solidity supersonic tip section with coupled LSB design
- Figure 3. Leakage-loss and flow-disturbance reduction with tip cover
- Figure 4. First application of combined HP/IP section on 80 MW steam turbine
- Figure 5. Combined HP/IP design with nozzle boxes
- Figure 6. Combined HP/IP design for sliding-pressure operation
- Figure 7. Single-shell construction for combined-cycle application
- Figure 8. Combined HP/IP design with short inner shell

*For further information, contact your GE Field Sales
Representative or write to GE Power Systems Marketing*



GE Power Systems

*General Electric Company
Building 2, Room 115B
One River Road
Schenectady, NY 12345*