

GE  
Energy

# Industrial Steam Turbine Value Packages

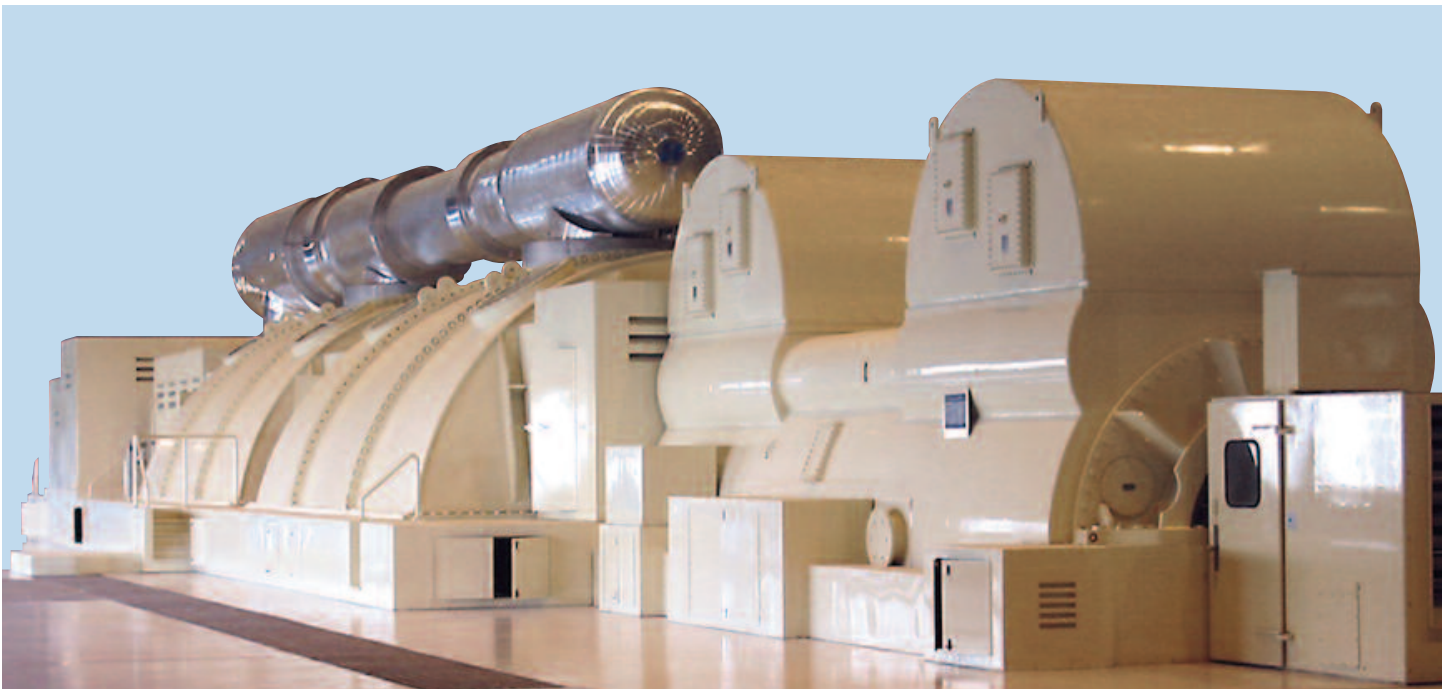

**Mark Scoretz**  
**Raymond Williams**

GE Energy  
Atlanta, GA

April 2008





# Contents

<b>Introduction</b>	<b>1</b>
<b>Industrial Steam Turbine Application Center (ISTAC)</b>	<b>1</b>
<b>Product Line Overview</b>	<b>1</b>
Direct Drive T/G Sets (26" LSB Max)	1
Geared T/G Sets	2
Mechanical Drive – API (Variable Speed)	2
BFPT/RFPT	2
<b>Modern HP Section Buckets</b>	<b>3</b>
SCHLICT Control Stage Buckets	3
SCHLICT Group Stage Buckets (SC Buckets)	3
HP Val-Pak	3
<b>Modern LP Section Buckets</b>	<b>4</b>
<b>3-D 20 inch LSB and Diaphragm</b>	<b>4</b>
<b>Metal Sections and Advanced Diaphragm Construction</b>	<b>5</b>
<b>Integrated Design System (IDS)</b>	<b>5</b>
Introduction	5
Layout	6
MST	7
Load Point Generator	8
MDI	8
Performance Curves	8
Conclusion	8
<b>Discussion on Valve Size Impact on Uprate</b>	<b>9</b>
Internal Control Valves and Value Packs	9
Fundamentals of Control Valves	9
Problems and Solutions	9
Valve Types	9
Value Pack Scope and Design Criteria	9
<b>Extraction Map Estimating Techniques</b>	<b>9</b>
<b>Partial Arc Loading</b>	<b>10</b>
<b>Nozzle Box Packing Redesign</b>	<b>10</b>
<b>FineLine Welding Value Package Solution</b>	<b>11</b>
<b>Value Packages – Conversion, Condensing to Non-Condensing</b>	<b>12</b>
<b>Refurbished Turbines</b>	<b>13</b>
<b>Upgrade</b>	<b>14</b>
Efficiency Uprate	14
<b>Power Uprates</b>	<b>14</b>
<b>BFPT/RFPT Value Packs</b>	<b>14</b>
Life Extension Programs	16
Reliability Improvement	16
Performance Recovery	17
Parts Replacement Planning	17

# Contents

<b>Advanced Seals Technology – Brush Seals</b> .....	<b>17</b>
IST Performance Benefit Analysis .....	17
Description of Brush Seal.....	17
Design Considerations .....	18
<b>Advanced Seals Technology – Variable Clearance Positive Pressure Packing</b> .....	<b>19</b>
Description of Variable Clearance Positive Pressure Packing (VCP) .....	19
Benefits.....	19
<b>Erosion Protection</b> .....	<b>19</b>
SPE-Resistant Stage 1 Nozzle Blades.....	19
SPE Thermal Spray Coating on Stage 1 Buckets.....	19
Flame Hardened Last Stage Buckets.....	20
All-Stainless Steel Diaphragms.....	20
Z-Joint Diaphragms.....	20
Shoot-Around Last Stage Diaphragms.....	21
Future Efficiency Gains.....	21
Leveraging ADSP and Dense Pack™ .....	21
STTV.....	22
<b>Conclusion</b> .....	<b>22</b>
<b>References</b> .....	<b>23</b>
<b>List of Figures</b> .....	<b>23</b>
<b>List of Tables</b> .....	<b>23</b>

# Industrial Steam Turbine Value Packages

## Introduction

For nearly a century, GE has been a leader in the steam turbine industry. With the experience of building over 10,000 units, GE is capable of offering unparalleled aftermarket solutions for its customers' needs. Reliability, performance, and maintainability have long been the hallmark of GE quality, and this continues with GE Energy's operating plant value packages. As the OEM, GE is in a unique position to offer packages that successfully integrate into the entire turbine system, and are backed by decades of experience and continued technology improvements.

The industrial steam turbine market offers some unique challenges to aftermarket offerings. The turbines that fall under this category are characterized by single casing designs, power ranges usually under 100 MW (averaging 25 MW), and often have controlled extractions that supply lower pressure steam to plant processes. Over time, plant processes and major station equipment change to suit an industrial customer's overall production needs. Extraction pressure requirements change, throttle steam pressures and temperatures change, steam requirements will deviate from original design, condenser parameters can differ over the life of the turbine, and power needs can change drastically. GE has the experience and capability to engineer solutions to customer needs. As the OEM, GE's design tools are calibrated to extensive testing and field experience. GE also considers the total turbine, and can determine the impact of any change in the machine on all other parts of the unit. As such, the GE offering is a total system approach to turbine conversions and uprates.

## Industrial Steam Turbine Application Center (ISTAC)

In addition to the steam turbine application engineering group at GE Energy headquarters in Atlanta, GA, GE also serves its IST customers through the Industrial Steam Turbine Application Center (ISTAC) in Fitchburg, MA. The ISTAC was established solely to provide direct technical and commercial support to GE's operating industrial steam turbine customers through GE's industrial steam turbine sales force. Discussions between customers, the GE sales representative and the Application Centers occur daily toward solving industrial steam turbine issues providing IST solutions to customer inquiries. Each Application Center has access to all OEM records, drawings, design tools and personnel in place to provide technical and commercial

support studies and proposals for parts and rebuilds. Our engineers have digitized the original turbine design records and drawings for the GE Industrial fleet for instantaneous access. The Application Centers are staffed with engineers experienced with GE industrial steam turbines in all areas:

- Thermodynamics
- Plant Heat Balance Studies
- Bucket Vibration
- Rotor Dynamics
- Heat Transfer
- Fracture Mechanics
- Finite Element Analysis
- Valve and Hydraulic Systems
- Instrumentation and Controls
- Packaging
- System Integration

This paper will give a brief overview of GE's experience and technology evolution throughout its industrial steam turbine fleet, illustrate how this technology has been integrated into a streamlined process to meet customer needs, and detail the types of total system packages that are available to the industrial customer.

## Product Line Overview

The industrial steam turbine product line serves in process plants, as auxiliary units in large utility plants, and in smaller independent power providers. The application of these machines varies. They drive main-unit feed pumps, compressors, blower fans, and generators. The range of operating speed, power output, and inlet conditions is vast. As *Figure 1* shows, GE has a full portfolio of units in all areas of industry utilizing its technology for power production.

### Direct Drive T/G Sets (26" LSB Max)

The GE fleet of direct drive turbine-generator sets for industrial application includes more than 6,000 units. These machines are characterized as generally being under 100 MW, having a maximum last stage bucket (LSB) of 26" and usually having a single turbine-bearing span.

### Geared T/G Sets

Turbine generator sets at lower power requirements can lead to a steam path with short buckets on relatively large rotor diameters. Such proportions lead to an inefficient steam path, which can be remedied by supplying a smaller machine operating at higher speeds to produce the required power, and using a gear to transmit torque from the turbine to the generator. GE's experience in geared turbine-generator sets spans over 40 units ranging in speed from 3600 rpm to 8500 rpm and the power output ranges from 3 MW to 35 MW.

### Mechanical Drive – API (Variable Speed)

Mechanical drive steam turbines must accommodate the speed and power needs of the driven equipment, as well as integrate into the plant's overall cycle by supplying process steam through extraction openings. GE has units in service running at up to 75,200 HP and at speeds up to 16,000 rpm. These mechanical drive machines have application in the ethylene, liquefied natural gas (LNG), refinery, steel, synthetic fuel, ammonia, methanol and other markets.

GE's fleet of mechanical drive steam turbines is over 380 units, and the design focus is on the customer need for high reliability and availability. Industry standards such as the American Petroleum Institute specification API-612, or the National Electrical Manufacturers Association (NEMA) specifications SM-23 and SM-24 are followed for all new units when required, and considered for aftermarket conversions and uprates. GE's mechanical drive product line has world-class reliability, with some customers being able to go 12 years between turbine outages.

### BFPT/RFPT

Since 1954 GE has supplied over 780 Boiler Feed Pump Turbines (BFPTs) / Reactor Feed Pump Turbines (RFPTs) to over 400 utility power plants throughout the world. These units are custom designed for each plant, and range from 2,800 to 26,000 kW in size with speeds ranging from 3490 rpm to 7575 rpm. GE BFPTs utilize a dual inlet design, where low pressure steam from the main unit cross-over pipe is used during rated operation, and high pressure steam is taken from the main steam source for start-up, part loads, or to boost the low pressure inlet steam during peak power demands.

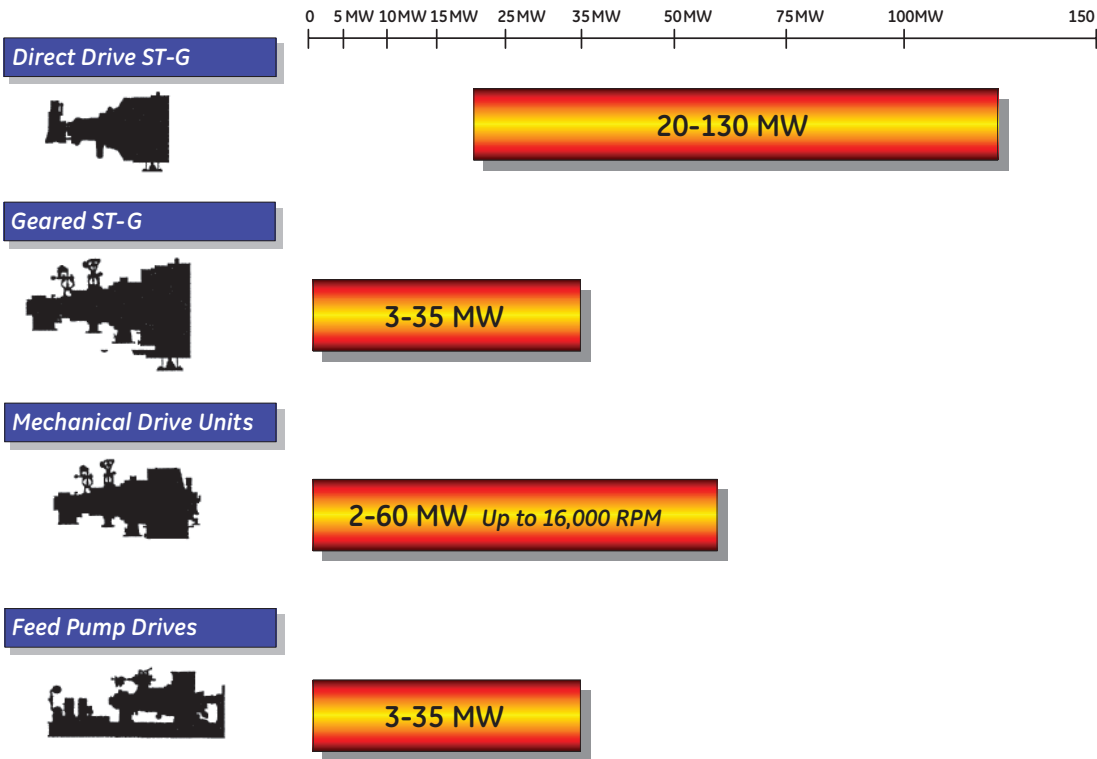

Figure 1. GE industrial steam turbine experience

## Modern HP Section Buckets

### SCHLICT Control Stage Buckets

The first stage of a turbine section must take the maximum amount of energy entering the section, extracting enough of that energy to reduce downstream stage loading, pressures, and temperatures. Early designs utilized a two-row wheel, or Curtis stage, to accomplish this for high inlet steam conditions, and a single-row wheel for units with lower inlet steam conditions. The Curtis stage could extract approximately four times the amount of energy from the steam as the conventional single-row stage more commonly used today. As materials technology improved and bucket designs became better, more efficient single-row control stages became the norm. The 54CSB was used for a long time. The 54 designated the approximate 1954-year of development for the bucket cross-section and the CSB designation classified the profile as a Control Stage Bucket. In the 1960s, a mathematical technique known as the “Schwartz-Christoffel Hodographic Laminar Incompressible Conformal Transformation” was used to design the class of profiles known as SCHLICT buckets. The SCHLICT buckets in the HP section are cylindrical, meaning they have a constant cross-section throughout their height. As GE continued development of its bucket profiles to ever improve efficiency and reliability, the term SCHLICT has been retained. The latest families of SCHLICT control stages are the 83CSBs, again named for the development year in 1983. These control stage buckets range in width from 1.00 inches to as wide as 3.00 inches, and can be manufactured with a variety of dovetail forms to attach to various existing rotor designs.

### SCHLICT Group Stage Buckets (SC Buckets)

For the other stages in the turbine characterized by constant axial velocity and constant energy transfer across the blade shape, SCHLICT Cylindrical, or SC buckets, are available. These buckets need not be as mechanically robust as the control stage design, and can therefore be more thermodynamically efficient. Typically the SC buckets are relatively short, allowing for the assumption of constant axial velocity. Over the years, these bucket profiles evolved to the current standard, and may offer greater stage efficiency over a greater operating range than previous designs. (See Figure 2.)

### HP Val-Pak

To provide customers with the benefits that can be achieved with new products introduced by GE, this value package gathers together new

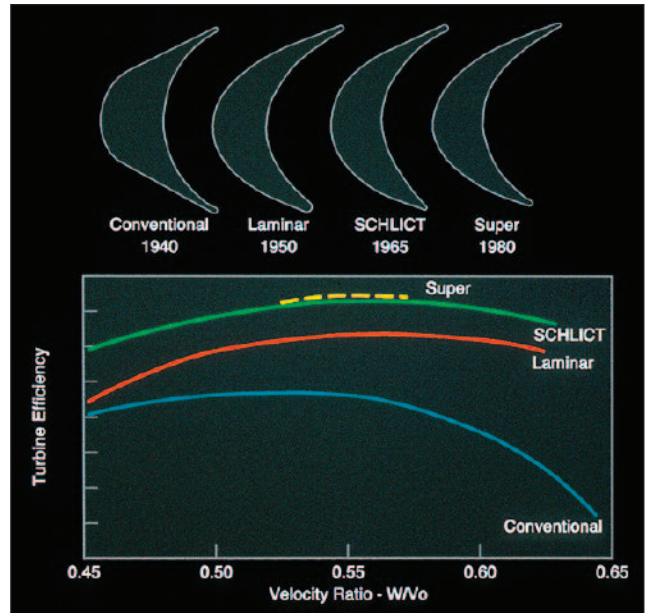

Figure 2. Evolution of cylindrical blade designs

technology that can enhance the performance of the existing industrial steam turbines. While some new products may be applied individually on a case-by-case basis, the maximum benefit can be achieved by applying the entire package to your system. (See Figure 3.)

### HP Val-Pak

- Retractable packing
- Closure blade group
- Z-Joint diaphragms
- Bucket tip sealing
- Brush seals – end packing
- Wheel balance hole optimization

Figure 3. HP Val-Pak new technology offering

Designed to help customers realize performance improvements within a two-year payback period, some of the features available through this offering include: end packing brush seals; leading and trailing edge tip seals for bucket tips; Z-joint diaphragms; closure blades; wheel balance hole optimization; and retractable packing.

Benefits of the HP Val-Pak offering include:

- Steam turbine performance increase (1.2% improvement in HP section efficiency)
- More robust design of Z-joint diaphragm (compared to standard split blade design) to eliminate occurrence of broken steam path half blades
- Brush seals to maintain degradation avoidance (not limited by irreversible rubs)
- Advanced closure blade design to help enhance performance without sacrificing component life

## Modern LP Section Buckets

As steam expands through the turbine and energy is extracted, the steam density decreases and greater annulus areas are needed to pass the required flow. This leads to larger bucket heights to match the nozzle sizes, and the assumption of constant axial velocity no longer holds. Because the velocity triangles change along the radial height of the buckets, the sections are optimized for inlet angle and pressure distribution along the height. These tall bucket designs also utilize the SCHLICT design methods, and are referred to as SCHLICT Vortex, or SV, buckets. Older designed tall buckets were of the double-taper type, or DT buckets, and nearly all of the old DT style buckets have a modern replacement SV equivalent that offers better efficiency. In order to gain the maximum benefit of the SV bucket design, a new design nozzle with similar vortex characteristics must accompany these stages, i.e., accounting for radial changes in pressure distribution and axial velocity. The new nozzles are also designed with increased setback, which reduces the stimulus on the bucket, hence minimizing bucket vibratory stresses.

## 3-D 20-inch LSB and Diaphragm

A new GE advanced 3-D profile 20-inch Vortex last stage bucket (LSB) and companion diaphragm was introduced in the mid 1990s. The design contains several new features resulting in significant performance and reliability advantages versus the earlier-

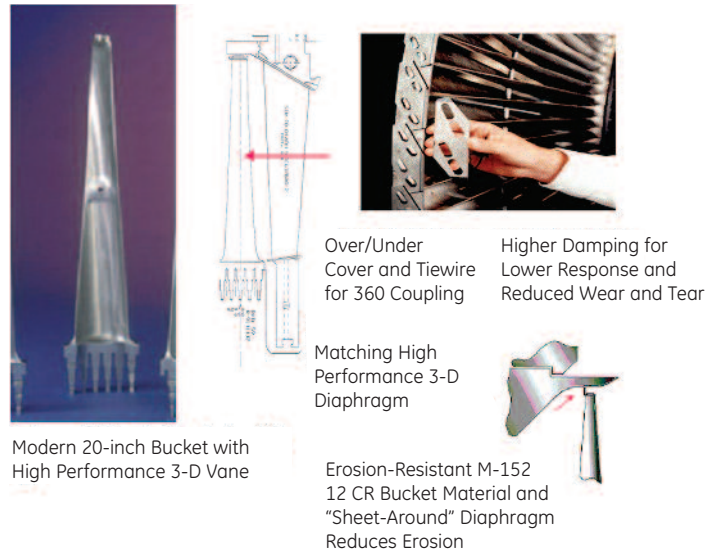

**Figure 4.** 3D 20-inch last stage bucket and diaphragm

generation double taper (DT) design introduced in the 1970s. See *Figure 4* for features of the new-generation 20-inch LSB and diaphragm.

Improvements in 20-inch LSB efficiency have resulted from improved radial mass flow distribution, control of tip supersonic flow, improved leakage control, and enhanced matching of vane section to flow. The new 20-inch design uses a matching diaphragm with 3-D advanced nozzle profile.

The new 20-inch last stage bucket and diaphragm (must be used together as a set) can result in up to 1% output improvement.

Mechanically, the reliability of the new 3-D bucket and diaphragm is significantly enhanced over the previous DT design. The new 20-inch bucket uses a patented over-under cover construction that accommodates untwisting without imposing undue stresses on the tenon or vane tip sections. The continuously coupled cover and 360° mid-vane tie wires achieve three (3) times better bucket modal suppression and damping than the old design. The bucket is also tuned to maintain its natural frequencies well removed from known sources of potential stimulus such as multiples of running speed. Maintenance is further reduced by using erosion-resistant M-152 12% Cr-Ni-Mo-V (trade name "JetHete") steel. The initial bucket and diaphragm investment can be recovered from fuel savings and an incremental increase in capacity revenues.



## Metal Sections and Advanced Diaphragm Construction

Nozzle metal sections have also gone through an evolution over the decades. The older 656 metal sections, named after the original GE drawing number used as the profile template, have been replaced with “A” metal sections for HP sections, and “N” nozzle metal sections for LP application. These newer metal sections offer up to 1.7% greater stage efficiency than the older designs. Because GE uses an impulse design in all of its machines, the nozzle theoretically takes the entire pressure drop across the stage. Thus stage efficiency is improved by better nozzle profiles which dictate pressure drop, even more so than by improved bucket profiles, which dictate steam turning effectiveness. (See *Figure 5*.) Conical sidewall designs are another improvement feature that has evolved in the design of the turbine steam path. In new designs, nozzle partitions are mounted into precision-machined holes in the inner and outer spacer bands. This assembly is then welded into the inner and outer support rings. Rather than a straight contour at the outer band, an angled design is used forming the conical shape. This gives improved steam guidance to the following stage, minimum flow deceleration, and maximum residual energy recovery. The EDM conical sidewall eliminates rough weld surfaces in the steam path, leading to better stage performance. The conical design and construction method allows for better expansion of the steam through the turbine, and the steam path design can accommodate progressive increases in stage height with lower secondary losses. (See *Figure 6*.)

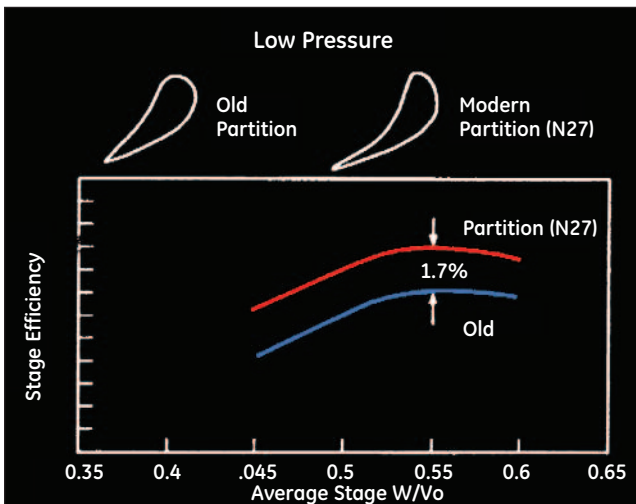

Figure 5. Improved nozzle design

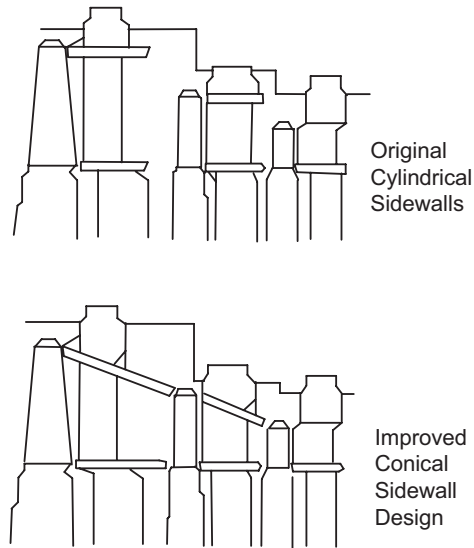

Figure 6. Conical sidewall diaphragm construction

## Integrated Design System (IDS)

### Introduction

IDS is GE's Industrial Steam Turbine Integrated Design System. Prior to the 10-year development of this computerized system, experts knowledgeable in a specific turbine design discipline engineered steam turbines. A typical engineering organization consisted of separate groups with performance, rotor, bucket, diaphragm and casing design expertise. Each group had its own stand-alone computer programs, which it developed, maintained and operated. Engineering a steam turbine was an organized collaborative effort initiating with the staging approximated by the thermodynamic design group. Based upon that initial thermodynamic design, each group in turn evaluated the steam path components using its own standalone programs and passing technical requirements and associated changes from one group to another. This data was always fed back to the thermodynamic design group for compliance with the contract performance guarantee. Since the industrial steam turbine fleet is designed using a structured building block approach it was possible to utilize a common database and link all of the previously standalone programs into one integrated system. This way all of the manual handoffs and potential for transactional errors were eliminated resulting in a Six Sigma methodology. All of the components available to the design engineer plus older components that would not be incorporated into a new design reside in an electronic database by component type. The building block method

enables a steam turbine to be completely customized to the customer's specific application yet be manufactured from existing components. The building block groups are front standard, high-pressure head, and extraction modules, exhaust casing and group stage barrel casings. The technical characteristics of each of these engineered components are stored in the vast computer database identified as Viewdes. (See Figure 7.) As new components are designed they are simply added to the database and become an additional "choice" for the ISD design system.

A new program had to be written in order to start the design process. The program created is called Layout and is armed with the knowledge from the best and most experienced thermodynamic principal engineers who spent a lifetime at their craft. Equations, selection criteria, and algorithms were developed in order to pick the right components from the database using the building block approach. All that is needed to start the program is knowledge of the product line, the customer's performance criteria and steam conditions. The following paragraphs describe the individual components of this integrated system and provide some insight to its capabilities.

## Layout

As previously mentioned, the Layout program is the first IDS module run by engineering. The program is designed such that any industrial steam turbine can be designed by the integrated system. The industrial steam turbine product line consists of T/G sets (either 50 or 60 cycle), mechanical drive variable speed turbines, boiler or reactor feed pump turbines, geared T/G sets and STAG units. Since different sets of design data rules apply and the geometry varies for each product line, the program needs to know what type of turbine it is. Then, steam conditions, speed and finally guaranteed output are "inputted" to the program. Using the components available in the Viewdes database, Layout is able to select all of the turbine components including the determination of the number of stages for each section. Once complete, it automatically loads the input to the stage-by-stage thermodynamic program called "MST" and runs it. Note that this is an internal iterative process as Layout needs performance feedback to confirm and optimize its component selection. For example, the program will automatically vary the first stage shell pressure and evaluate the impact on the high-pressure seal. As the shell pressure increases, stage

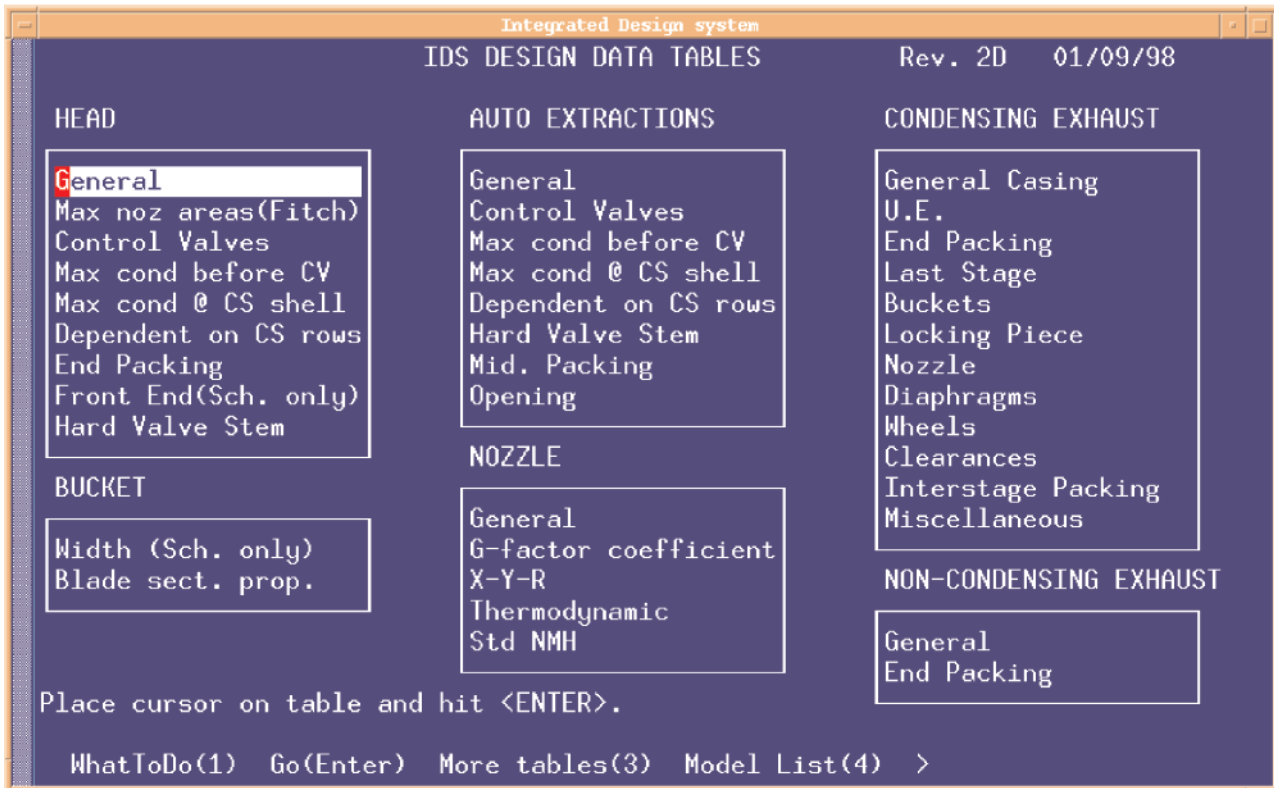

Figure 7. Screenshot of Viewdes database menu

performance goes up but seal leakage increases. The program will specify the most efficient turbine design taking the leakage loss in account even if the first stage is slightly off design.

### MST

“MST” is the stage-by-stage turbine thermodynamic program developed by GE’s Medium Steam Turbine facility in the early 1980s. The program has been calibrated for IST components based upon development lab testing and actual field operating experience. No other program can more accurately predict the stage-by-stage performance of a GE IST. A part of the program’s input is an element array that describes the complete steam turbine cycle. The program is not limited to just a few typical steam turbine installation arrangements but is fully capable of modeling just about any turbine facility and its impact on the turbine. Controlled extractions, uncontrolled extractions supplying customer process flow, feedwater heaters as part of a regenerative cycle and other plant specific configurations can be accurately modeled. In addition Layout can be run on the actual plant cycle and further optimize the turbine thermodynamic design. (See Figure 8.)

This stage-by-stage performance program actually performs an independent heat and flow balance on every stage. Many of the significant stage characteristics taken into account by this program are described below.

- Bucket reaction
- Bucket and nozzle efficiency based upon a stage reaction modified velocity ratio
- Bucket tip and root leakage flows based upon reaction, clearances and type of seals
- Variation in tip /root seal configurations permitting evaluation of advance seals
- Wheel pressure gradient and associated windage loss
- Steam balance hole radial locations
- Steam to bucket incidence angles
- Bucket and nozzle surface finish

Since the surface finish of both the nozzles and buckets can be evaluated this program can be utilized to accurately evaluate the

Integrated Design system												
BUCKET DATA											STAGE # 1.0	
STAGE NUMBER	---HEIGHT---		---WIDTH---		-SLANT ANGLE-		---# BUC/360---		IDENT	BLADE SHAPE	D	
	ENTR.	EXIT	ROOT	TIP	OUTER	INNER	DESIRED	OMITTED				
1.000	1.630	1.630	1.560	1.560	0.00	0.00	114.00	2.0	29/24	54CSB	N	
2.000	1.310	1.420	0.750	0.750	0.00	0.00	190.00	2.0	27/22	1940	N	
3.000	1.420	1.650	0.750	0.750	0.00	0.00	190.00	2.0	27/22	1940	N	
4.000	1.570	1.940	0.930	0.930	0.00	0.00	152.00	2.0	27/22	1940	N	
5.000	2.960	1.170	1.560	1.560	0.00	0.00	118.00	2.0	29/24	54CSB	N	
6.000	1.650	1.570	0.750	0.750	0.00	0.00	190.00	2.0	27/22	1940	N	
7.000	1.840	1.940	0.750	0.750	0.00	0.00	190.00	2.0	27/22	1940	N	
8.000	2.900	1.300	1.000	1.000	0.00	0.00	190.00	2.0	29/24	54CSB	N	
9.000	1.310	4.050	0.750	0.750	0.00	0.00	278.00	2.0	27/22	1940	N	
10.000	2.210	4.230	0.750	0.750	0.00	0.00	278.00	2.0	27/22	1940	N	
11.000	3.630	6.470	1.125	1.125	0.00	0.00	182.00	2.0	27/22	1940	N	
12.000	6.285	10.540	1.250	1.250	0.00	0.00	170.00	2.0	27/22	1940	N	
13.000	10.000	10.000	2.000	1.480	0.00	0.00	142.00	2.0	V/26	DT	N	

Save(0) Page 1(1) Page 2(2) Page 3(3) Page 4(4) >

Figure 8. Screenshot of MST bucket detail screen

impact of surface wear on turbine performance. This information can then be utilized in a payback analysis and help drive the commercial decision regarding bucket and or nozzle replacement. In conjunction with Layout the program can be run under a “casing constraints” option. This option allows Layout to redesign only a portion of an existing machine based upon new flow requirements and yield an optimal design that will actually fit within the existing casing envelope. Increases in flow have a tendency to require taller buckets that may not fit within the actual casing. The program will non-optimize the design by eliminating spill strips, minimizing area ratios and increasing an arc from partial to full. It does this one step at a time based upon the smallest impact on efficiency.

### Load Point Generator

Once the steam path is optimized thermodynamically it must be evaluated for mechanical reliability. Based upon the turbine type and configuration the load point generator runs MST for all possible combinations of pressure, temperature, flow and speed as required. The program then fills an array which records the maximum and limiting operating conditions including temperature, pressure, flow and power for every stage.

### MDI

The mechanical drive interface program called MDI is utilized to mechanically evaluate the internal steam path components. The components include nozzles, buckets, diaphragms and rotor wheels. The analytical portion of the program was developed by GE's Large Steam Turbine department and modified to accommodate IDS including variable speed mechanical drive turbines. This program takes input from the load point generator that again assures Six Sigma quality transactional data transference from the thermodynamic-based programs to the mechanical analysis programs. The MDI program is actually constructed from a number of stand-alone programs that collectively perform the following analyses:

- Bucket steady state and centrifugal stress
- Nozzle partition steady state stress and trailing edge stress
- Bucket locking piece stress
- Bucket tenon stress
- Bucket band centrifugal and edge bending stress
- Bucket nozzle passing frequency stress

- Bucket per rev frequency stress
- Wheel stress including balance hole tangential stress
- Wheel vibratory stress
- Diaphragm stress and tie in weld stress

As part of IDS, MDI is more than just an analysis program. When it finds a component that does not pass current design criteria, it reselects another component from the Viewdes database and then evaluates the new selection. Once it selects an acceptable component the program “writes back” that new component into the Layout database. The program was designed to simply use brute force to select its candidates. Utilizing the stage Reynolds Number the program can determine what is the most efficient bucket and nozzle combination. It then simply tries every combination from highest efficiency towards the lowest until it comes up with a combination that is acceptable. Though not a very sophisticated method it does result in the most efficient design that can actually meet all design criteria.

### Performance Curves

Once the mechanical design is complete the performance curve section can be utilized to create all of the appropriate performance curves dependent upon turbine type and configuration. The guarantee point is described on a performance map or Willans Line. Section enthalpy curves and associated correction curves for pressure, temperature and exhaust conditions are also created.

### Conclusion

Once a given turbine is modeled on the IDS system a very powerful analytical tool is available to evaluate the impact of any design change. GE is in the unique position to be able to completely and accurately determine the impact of one change on the entire turbine system. Anything from changes in operating conditions, bucket surface finish deterioration, stage removal, application of advanced components, etc., can be quickly evaluated not only for the impacted part but for all the other steam path components as well. And, since the system is a computer integrated system and does not rely on manual engineering handoffs, Six Sigma quality is assured. Another contributor to Six Sigma quality is the use of the program not only for detailed requisition designs but for proposals and studies as well. Utilizing the same program and database for both ITO and OTR engineering assures the requisition engineers of a Six Sigma handoff from the proposal team.

## Discussion on Valve Size Impact on Uprate

### Internal Control Valves and Value Packs

As part of most value packs the internal throttle control valves and seats are changed along with portions of the operating mechanism and bushings. In general, any time throttle flow has increased enough to warrant a new nozzle plate, the valves, seats and their controlling components are redesigned taking these new throttle conditions into account. This equipment must be redesigned in order to make sure the governor can effectively control the performance of the turbine throughout its entire operating range.

### Fundamentals of Control Valves

The primary function of the control valves is to regulate the flow of steam into the turbine in a controlled and precise manner. To be effective the valves must display the following characteristics:

- Operate at large and small pressure drops
- Operate without chatter over a large range of openings
- Operate without causing governor instability
- Minimize pressure drop—pressure drop is an unrecoverable energy loss
- Close quickly in emergencies
- Regulate flow proportional to lift

### Problems and Solutions

There are two basic problems that must be solved in order to provide a valve gear assembly that meets the above characteristics. The first is the fact that the valve flow lift characteristic is only linearly proportional over a limited range. The second is the fact that throttling losses at part load reduce turbine efficiency. The solution is a multiple sequential valve arrangement properly designed resulting in a linear flow proportional lift characteristic. This flow versus lift characteristic is referred to as the regulation or R Line. The key design issue is to determine when each valve should open such that a good, linearly proportional R Line results.

If the valves are lifted too far apart there is not enough overlap that results in flat spots on the R Line. When the governor hits a flat spot and calls for more power, it opens the valves yet the flow does not increase. The result is a governor that cannot effectively control the turbine. If the valves are opened such that the overlap is excessive, the R Line is at least linear but much too steep. When the R Line is too steep, a very small change in lift results a very large change in

turbine power. Again, the governor will not be able to effectively control the turbine. The best R Line is established when the valve overlaps are set at the governing point of the valve flow versus travel characteristics. The pressure ratio at the governing point varies somewhat as a function of valve type but it is between 7% and 13%. As a comparison, the pressure drop for correctly sized valves wide open is only 1.8%.

### Valve Types

GE ISTs use one of three types of valves. They may be poppet, either venturi or angle seat, spool valve or a grid valve. Each valve type has its own features, advantages and disadvantages. Thus, valve type is selected based upon where it is located in the turbine, maximum flow and pressure. These valves can be operated by either a bar lift mechanism or a cam lift mechanism depending upon the operating steam pressure and hydraulic force needed to stroke the valve assembly. Grid valves are used in LP sections only and up to 50 psig maximum. Spool valves can be used in either IP or LP sections up to 600 psig. Poppet valves can be used up to the highest pressure and actuated by a beam or cam as a function of throttle pressure.

### Value Pack Scope and Design Criteria

Whenever flow is significantly increased or the steam conditions have changed, new valves and associated operating mechanisms are required. In order to properly select new valves and determine proper lift points assuring a good R Line requires knowledge of the stage-by-stage operating parameters of the turbine. In addition, valve flow characteristics, cam rates, blow out forces, hydraulic limits must be known so that the valve impact on the entire turbine as a system can be evaluated. Utilization of the industrial steam turbine integrated design system that accurately calculates stage-by-stage performance also takes the valve sizes and governing point pressure ratios into account. Only this complete GE systems approach can effectively assure that the entire turbine will perform as guaranteed.

### Extraction Map Estimating Techniques

One way to give a cursory estimate of a unit's uprate potential is to extrapolate the extraction map to higher throttle flows. As the lines move upward on the map towards these higher flows, the power output will increase linearly. This method is a good estimate when steam conditions are unchanged or very close to the original design. The turbine limitations at major connections and in the steam path will dictate the true uprate capability of the machine, but this estimating

technique may give the customer an idea of how much more steam is required to meet an uprate objective, and determine if this is feasible from a total plant standpoint. Once this has been determined, GE can do a much more refined review to identify parts changes needed to pass such flow, and verify the mechanical suitability of the greater stage loading. These final detailed calculations will likely yield lower power output or higher steam flow requirements, or identify other limiting factors that will prohibit the full uprate. (See Figure 9.)

## Partial Arc Loading

The effect of partial arc loading on bearing stability can be illustrated with Figure 10. Much of the industrial steam turbine fleet utilizes inlet modules that feed less than a 360° arc. As such, the resulting force vectors due to each valve opening are not symmetric, and the bearing load is no longer directly down as with dead weight loads. The resultant force vectors can impart a horizontal force component, or even an upward vertical component, which unloads the bearing and leads to instability. GE has the ability to analytically determine the magnitude of these partial arc valve forces at each valve point, and calculate the vector direction and magnitude at the bearings. GE also has the ability to evaluate the bearing geometry and turbine specific loading conditions, and correlate to a stability factor. Engineering can then make recommendations for bearing modifications and upgrades to minimize or eliminate rotor instability.

## Nozzle Box Packing Redesign

The nozzle box packing is a labyrinth seal located between the nozzle box and the rotor assembly. Its role is to impede the flow of steam along the rotor shaft from the first stage shell into the front of the machine. The nozzle box packing design on older mechanical drive turbines is susceptible to buckling and rubbing. This results in failure of the seals and excessive steam leakage from the HP end. Efficiency loss of up to 5% can occur if in fact the packing does fail. One problem associated with the original, wide packing with a large overhang (Figure 11) is the relatively high steam pressure forces and moments. This could result in the packing not returning to its proper location after a transient rotor rub during startup. This is referred to as packing instability.

Packing instability can result in uneven contact pressure distribution along the packing teeth causing accelerated wear of the teeth toward one end. In certain applications, the swirling effect of the steam leaking through the packing causes a

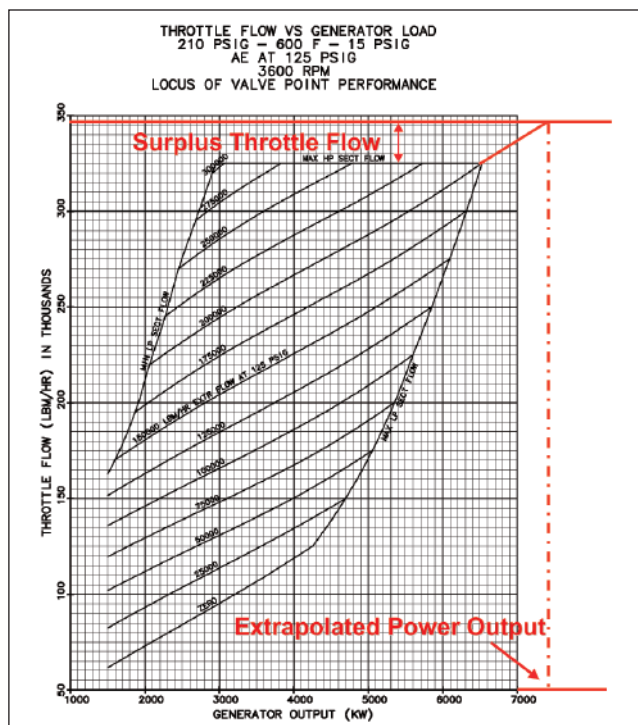

Figure 9. Extraction map extrapolation

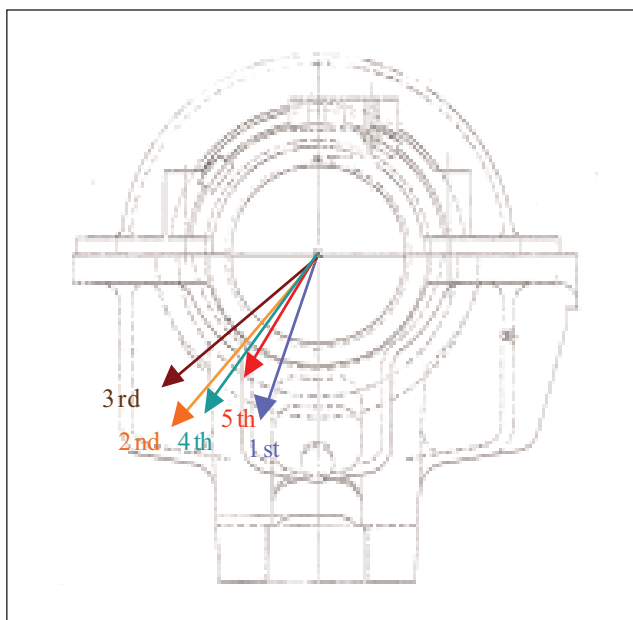
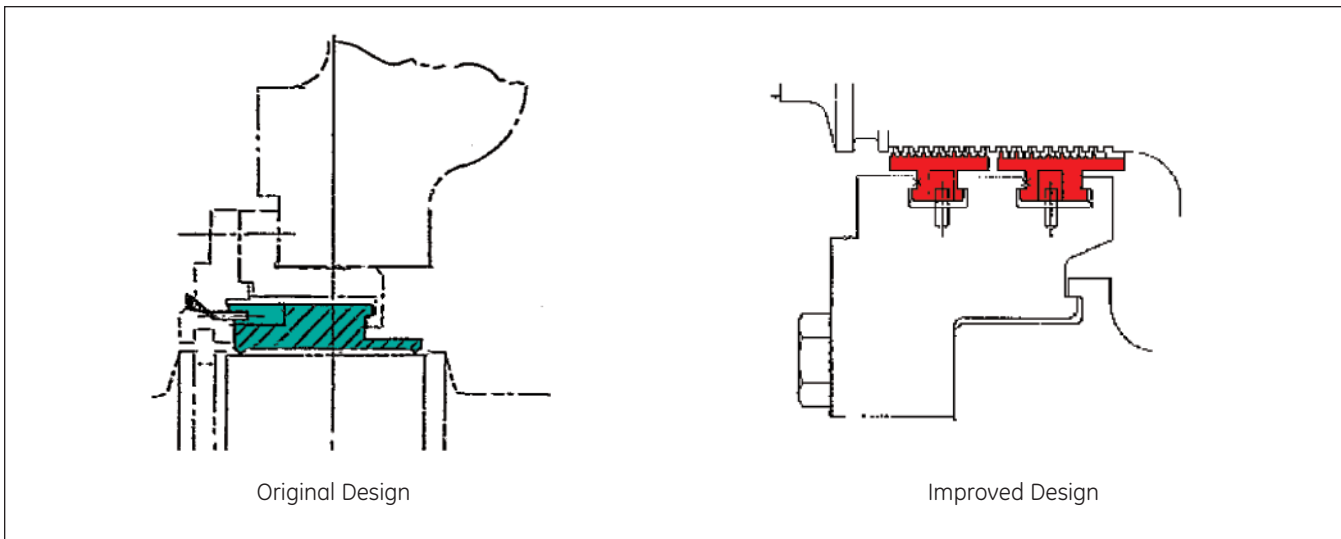

Figure 10. Sketch of bearing with partial arc valve forces for each valve point. Vector magnitudes are to scale relative to each other.

destabilizing effect, which contributes to rotor instability. Another problem associated with the original designed packing is the presence of stress creep in the packing holder rings. This is due to the high axial steam forces on the packing and holder. Over a



**Figure 11.** Comparison of original and improved nozzle box packing designs

period of time, this could result in added holder deflection and both axial and angular packing offset. This could result in added rubbing and tooth wear. The solution to these problems was to redesign the packing holder and the packing rings (*Figure 11*).

The new packing design incorporates two shorter rings instead of one long packing. This new design will allow for more even pressure distribution along the packing teeth. The newly designed packing holder is a one-piece design. The one-piece holder allows for better dimensional control. The new design incorporates a thicker neck that results in lower stresses. The new packing housing design requires a machining modification to the nozzle box ID to provide the proper dimensional interface (which includes new bolting pattern). New packing is required (2-ring design). A new nozzle box assembly bearing will also be required.

## FineLine Welding Value Package Solution

A petrochemical plant located in the southwest United States advised that due to a change in plant operations there was no longer a need for HP extraction flow. Their unit is a single auto extraction condensing mechanical drive turbine driving a centrifugal compressor. The customer requested GE to investigate the potential to minimize extraction flow and pass the remaining steam through the low-pressure section to the condenser.

This modification would result in an LP section flow increase of 49%. In order to pass this much more flow, significant changes to the LP section would be needed. New taller buckets and associated

diaphragms to keep vibratory stress to acceptable levels would be required. The stage immediately just downstream of the control stage would have to be removed.

Removing the diaphragm and cutting the buckets off at the root eliminate this stage. By eliminating this stage, the pressure ratio across the control stage increases which permits more flow to pass for a given nozzle area. This method is very effective in increasing section capacity but there is an efficiency penalty to pay. The taller buckets, increased nozzle area diaphragms and stage removal opened up the turbine flow passing area enough to pass the required steam. However, the last stage bucket, even though it was manufactured with GE's largest industrial steam tangential dovetail, would not pass its per rev vibratory stress criteria. In order to meet the flow criteria established by the customer, somehow, the last stage bucket would have to be changed. The only alternative available is to utilize an axial entry dovetail bucket with integral Z lock bands. Z lock covers are effective in simultaneously decreasing the resonance response factor and increasing system damping. The axial entry dovetails were adopted for use in variable speed turbines with very high dovetail stresses. Use of these dovetails in lieu of the conventional tangential type permits the utilization of taller buckets at higher speeds.

The Z lock banding assures that vibratory stresses related to multiples of running speed are acceptable. There was a basic problem, however, that needed to be solved. How could the rotor be modified to enable the last stage dovetail to be changed from a

tangential type to an axial type? One very laborious method is to cut off much of the wheel and build up the area with weld, heat treat and final machine. This is recognized as a class IV repair. Another welding method pioneered by GE which is much less time consuming, is called "FineLine welding."

This was the method proposed by GE's Applications Engineering team. FineLine welding is a process that combines traditional processes with fiber optics, video and computer controls. This is a new proprietary process and was originally developed by GE's Nuclear Energy business for nuclear pipe welding. It has been adopted for use on steam turbines to repair dovetails and diaphragms. The process itself is a modified orbital gas tungsten-arc welding process that offers significant improvements over standard and narrow groove techniques. The FineLine welding process can weld up to a six-inch deep groove with a maximum width of .250 inches. The method employs a synergic-pulsed GTAW process. The weld head moves on a track surrounding the wheel. Small diameter .021" wire is used and a video camera permits real time inspection of the leading and trailing edge as the weld progresses.

The concept is to cut a portion of the wheel off the rotor at a region of low stress. Typical location would be between the steam balance hole and the dovetail root. Then, instead of building up the area with weld, the fine line technique is used to weld on a forged ring. This method significantly reduces the amount of weld, thereby minimizing weld volume, distortion and increases weld quality. This type of repair offers several advantages over the class IV repair. The welding can be performed on site or any service center as the equipment is portable. Machining the dovetail into a forging instead of built up weld offers increased strength and the welding is confined to a relatively small low stressed area. GE application engineers using the industrial steam integrated design system to assure a complete systems analytical approach were able to effectively evaluate a very difficult proposal and offer a value package solution. GE's Six Sigma computer design tools and synergistic approach to developing state-of-the-art technologies was able to offer the customer a solution that just a short time ago would not have even seemed possible.

## Value Packages – Conversion, Condensing to Non-Condensing

Based upon GE's ability to evaluate the turbine as an entire system it is usually possible to extensively modify a steam turbine in order to accommodate dramatic changes that occur over time in plant operations. Due to this systems analysis approach, the customer can be confident that the modified unit will perform reliably and as guaranteed. A recent example of a systems analytical approach that also required significant amount of creative engineering was a value pack request to convert a 3600 rpm generator drive turbine from a condensing to a non-condensing unit.

A large increase in 25-psig process steam flow was needed at a sugar processing plant located in the southeast United States. The most economical means of obtaining this much flow was by extracting power from the steam via expansion in their existing steam turbine and then exhausting the steam at 25 psig instead of directing it to the condenser.

The original turbine contained 14 stages with a double tapered 11.4" tall last stage bucket exhausting to a surface condenser. It was built to be installed within a regenerative feedwater heating cycle and was thus fitted with uncontrolled extraction openings. To convert this unit to a non-condensing turbine required modification to the rotor, exhaust casing, low-pressure seals, steam seal system and the addition of a breakdown diaphragm. Three casing connections at the 10th and 12th stages were effectively utilized to accommodate the 25-psig exhaust flow.

Removing the last three stages in order to maintain shell pressures consistent with the original design modified the rotor. The stages were removed by cutting the wheels off at their root diameter. In addition, the exhaust end of the rotor was machined to accommodate new low-pressure seals that utilize a high low labyrinth packing design.

The exhaust hood received extensive modification in order to be capable of handling 25 psig non-condensing steam. Fortunately, this hood contained internal extraction belts that could be adapted to be used as exhaust ducts. On typical non-regenerative cycle units, these extraction belts do not exist and two large diameter pipes must be installed instead. They are then routed through the exhaust hood condenser opening.



The existing extraction openings and internal belts normally operate at very low pressure. These casing internal extraction belts were analyzed in order to evaluate the impact of the 25 psig operating pressure. The analysis confirmed that the internal belts had to be strengthened. External and internal ribs were designed and then welded and stress relieved on site providing the additional strength required for reliable operation.

A breakdown diaphragm is installed in the L-1 diaphragm groove to act as the low-pressure head and is designed to handle the 25-psig exhaust pressure with minimal deflection. It is clamped in place so that its position is positively maintained regardless of local pressure or temperature. The breakdown diaphragm bore is machined and fitted with the new low-pressure seal. Due to the stiff design of the breakdown diaphragm and resultant minimal deflection the LP seal can be built with high low labyrinth seals effectively minimizing steam leakage and associated losses.

Three uncontrolled extraction openings were used to handle exhaust flow. Since a total of 300 square inches was needed to maintain acceptable exhaust steam velocities, two of the connections had to be increased in size. These three connections were manifolded together on site. A 24" trunk line was then installed between the manifold and the customer's existing piping to complete the tie-in of the turbine to the process.

Associated changes to the steam seal system were completed since steam will now be leaking out instead of in through the LP seal. A new, larger gland condenser and re-routed steam seal piping completed the seal system modification.

Not all turbines are manufactured with an exhaust casing that is built with internal extraction belts that can be converted to exhaust ducts. A major university recently also requested GE to convert its turbine from condensing to non-condensing. This particular steam turbine was an older vintage machine manufactured with a cast iron exhaust casing. A design approach similar to the Sugar Mill machine just described was adopted. Removing the last 4 stages of a 14-stage unit modified their rotor. A breakdown diaphragm bored for a new low-pressure seal and fitted with two 180-degree clamping rings was provided.

Since there were no extraction belts to take advantage of, two 8" NPS pipes were welded to the upper half of the breakdown

diaphragm. These pipes run vertically down and exit the casing through the hood condenser flange. Due to the close proximity of the condenser to the exhaust casing, the condenser had to be removed. The exhaust casing had to be modified to provide adequate clearance for the new exhaust pipes. Portions of the inner barrel were torch cut away and the resultant surfaces ground smooth. In addition, the internal steam seal pipes needed to be rerouted to avoid interference. A larger skid-mounted motor driven blower and tank replaced the existing vacuum pump/spray chamber type seal system.

Though extraction belts were not available for conversion to exhaust ducts, this unit was effectively modified from a condensing to a non-condensing turbine fully meeting the needs of the customer's new operating scheme. Since GE was able to utilize existing records, all of the components were pre-engineered and delivered on site ready to be installed. Modifications to the turbine exhaust casing were described in detailed drawings so that the field services organization was completely prepared for all the casing modifications and installation effort. The result was a timely installation of this value package and successful commissioning of the unit meeting all of the customer's expectations.

GE's systems approach allows the impact of such a significant change to be evaluated on every component of the turbine. Bucket stresses, diaphragms loads, changes in shell conditions, casing stress, effect on rotor dynamics, throttle characteristics, etc., are all accurately taken into account when analyzing the turbine as a complete system. A steam turbine is not simply a collection of individual parts such that one can be modified without an impact on the other. GE as the OEM is in the best position to correctly evaluate any changes made to the turbine as all of the stage-by-stage operating parameters are accurately known, not just estimated. The result of this value package is a highly reliable unit meeting the needs of the plant and performing as guaranteed.

## Refurbished Turbines

Refurbished turbines can present a cost effective solution to a customer's power needs. Components such as shells and casings can be expensive, long lead-time items and when a close match for a customer's steam conditions and power needs can be found in inventory, this may be a practical way to suit plant requirements quickly. Much work must be done to ensure that the unit will meet the current plant requirements. Typical scope will include valve

components, diaphragm replacement to ensure adequate flow passing capability and/or improved efficiency if desired, and replacement buckets to match any changes to nozzle height in the new diaphragms. Often, significant rotor work must be done, or a new rotor supplied to accommodate any bucket dovetail changes to meet all mechanical design criteria.

One example of a successful refurbished turbine application was for a paper mill in the central United States. Substantial changes in all steam conditions and flow required a new rotor and all new diaphragms. The new rotor included an extended LP overhang for good train torsional performance. The diaphragm replacements included a new fabricated HP auto extraction diaphragm to replace the existing case steam chest extraction diaphragm. A new LP auto extraction grid valve diaphragm was also provided. In addition, a new oil system and electronic governor were provided. (See Table 1.)

	Original Operational Parameters	Reapplication Operational Parameters
Inlet Temperatures (F°)	750	675
Inlet Pressure (psig)	400	425
First Auto-Extraction Pressure (psig)	155	135
Second Auto-Extraction Pressure (psig)	50	50
Exhaust Pressure (in-HgA)	2	1.5
Power Output (MW)	8	10
No. Stages	15	12

Table 1. Successful refurbished turbine application

## Upgrade

### Efficiency Uprate

In 1997, a paper mill in the southeastern United States needed to replace aging components in their 32 MW unit. Rather than an in-kind replacement, GE offered to increase the turbine efficiency by replacing the older parts with the latest steam path designs. The original design for the unit consisted of a 10 stage, single auto-extraction, and non-condensing steam path. The scope of supply for the uprate included a new rotor with SCHLICT buckets, all new diaphragms with high efficiency metal sections, interstage packing at each stage, and a new 1st stage nozzle plate and 8th stage

extraction diaphragm. After incorporating all of these modern components into the machine, the thermal efficiency increased by approximately 3%. An additional 5% efficiency gain was predicted just through performance recovery by replacing deteriorated parts with new ones. The need to replace the aged parts was the main reason for the success of this uprate. Because the parts were required replacement as part of normal maintenance, the economics easily justified the replacement with the higher efficiency components.

## Power Uprates

Recently a chemical-producing plant in Canada placed an order seeking to uprate a compressor drive turbine from 59,000 HP to 62,000 HP. As a mechanical drive machine, primary concerns were with ensured reliability. GE was able to engineer a low cost solution that delivered the required power increase. The uprate included control valve components, a new first stage including a new nozzle plate, and one group stage diaphragm. The valves and control stage flow areas were increased to allow higher throttle flows. The replacement downstream stage was in the HP section, and was replaced to ensure that deflection would not lead to packing ring contact with the rotor. The remaining stages in the machine were thoroughly evaluated to make sure that mechanical loading would not be an issue. Because GE has the ability to use IDS to calculate stress levels in the entire steam path, existing equipment can be evaluated at off-design conditions. This way, only parts that truly need replacement are recommended to be changed. And the customer can achieve uprate objectives at the lowest cost, while still maintaining long-term, safe and reliable operation.

## BFPT/RFPT Value Packs

GE's Mechanical Drive Turbine Department in Fitchburg, MA produced hundreds of boiler and reactor feed pump turbines beginning in the early 1960s. These turbines were built to be extremely reliable and to provide a significant amount of margin based on the potential for off-design conditions once the plant became operational. The primary objective when designing the feed pump turbine was to assure that regardless of the crossover steam conditions or actual condenser vacuum, the feed pump turbine would never limit the plant output. Thus these units were not initially designed with efficiency in mind but operability and reliability. However, once that plant is in operation and the actual

crossover steam conditions and condenser vacuum are well known it is possible to dramatically improve the efficiency of these units by removing the excess margin and designing to optimize efficiency based upon actual operating parameters. Usually two BFPTs were provided for each main unit. In this case the units are considered half size. These were highly structured in the early 1970s and were called UT-70s. This model simply meant utility, 1970 structure. Minor changes were made in the 1980s and these were called UT-80s. Though some changes were made to the design the essential structure of the steam path remained intact.

A boiler or reactor feed pump turbine is basically a variable speed mechanical drive turbine built to be very robust. They came in two frame sizes, 62" and 51", which are the GE, exhaust casing designations. The 62" was fitted with a 10.2" tall last stage bucket and the 51" was fitted with a 8.36" tall last stage bucket. Various last stage bucket nozzle areas were available based on flow requirements. The control stage structure consisted of six combinations that were selected again based upon flow considerations. There were either 4 or 5 group stages depending upon available energy. The result was either a 6 or 7 stage condensing variable speed turbine. Frequently, a 7-stage casing was manufactured even if there were only 6 stages.

The unique feature of these units is the capability to operate on either low-pressure crossover steam, high-pressure steam or a combination of the two. The control system and valve actuation mechanism is designed to open the internal low-pressure valves first and continue to open them until the plant conditions are satisfied. If low-pressure steam is insufficient, the valve gear continues to open until the high-pressure steam control valve is actuated. Thus, the energy required by the turbine to drive the feed water pump can be met regardless of the availability of LP steam.

These units were designed with angle radius angle buckets and three radius nozzle metal sections. The change in height from one stage to the other was rather large and little attempt was made to optimize the steam path to gain efficiency. Leakage control devices were not usually used on the bucket tips. Straight tooth labyrinth packing was commonly used for interstage seals. The HP seals were designed however with high low packing. These construction characteristics were very typical for that era when reliability and an extremely conservative design approach was taken due to tolerances on crossover steam conditions.

With the recent increase in fuel expenses experienced by utilities, increasing the efficiency of the feed pump turbine may be a commercially viable means of improving plant heat rate. The potential for the plant is in the order of 0.2% to 0.25% improvement in overall heat rate for an associated 10% gain in feed pump turbine performance. The gain varies as a function of the size of the plant. The higher the MW rating the greater the impact by the feed pump turbine.

To significantly improve the performance of the feed pump turbine will require an entirely new steam path designed with today's efficiency enhancement features. Also, the re-design must take into account that the original units were extremely conservative and usually ran well away from the design point. Clearly, optimizing the steam path around known operating parameters to run at its design point can yield significant efficiency gains.

The value pack will consist of a new 7 stage solid rotor fitted with high efficiency SCHLICT buckets. The high-pressure buckets will be SC buckets with round skirts. SC buckets are SCHLICT buckets with a constant cross-section. The first stage will be a special flat skirt SC control stage bucket. The taller back end buckets, L-0 and L-1 will be SCHLICT vortex buckets. These are twisted tapered buckets designed to optimize thermal performance from root to tip taking the variation in bucket tip speed and steam incidence angles into account.

All of the diaphragms will be manufactured with modern high efficiency nozzle metal sections. A "strengthened battleship" section will be used on the low-pressure nozzle plate. This section was designed to handle high partial arc loading typically experienced on control stages yet still be very efficient. The high pressure group stages will use "A4C" metal sections that are optimized for high Reynolds Number stages and associated low-pressure ratios. The low pressure end stages will use "N" which have been designed for low Reynolds Number high-pressure ratio stages.

Modern conical diaphragm sidewall construction will be used on the stages that have significant increase in stage nozzle mouth height from one stage to the next. Also each group stage will increase in inner ring diameter in order to be able to use buckets with both slant roots and tips. The result is a very effective steam path with little loss in stagnation pressure due to unconfined steam expansion.

High low interstage labyrinth packing will be utilized throughout the unit. Tip spill strips will be incorporated into the diaphragm design

to minimize bucket tip leakage loss. Advance seals such as brush seals can be installed at the shaft end seals, interstage and at the bucket tip. Multiple tip seals are another option at the bucket tips.

As discussed, there is significant room for improvement regarding the efficiency of the older boiler and reactor feed pump turbines. Utilization of modern buckets, nozzle metal sections, conical sidewall diaphragms and advance leakage control devices combined with a steam path optimized for the actual steam conditions will result in a dramatically more efficient turbine. This feed pump turbine efficiency improvement may make the feed pump turbine value pack a commercially viable and effective means of improving the plant heat rate.

### Life Extension Programs

Many plants are operating with equipment that is approaching the end or has already exceeded the 25–30 year design life of the machines. GE can offer a program to extend the useful life of these turbines, by instituting a life extension program. As the OEM, GE is able to rely not only on its knowledge of the service history of the machine, but of the entire fleet of steam turbines that have similar components, and the known aging mechanisms that are common to all. By applying current standards for mechanical and thermodynamic design, GE can compare the as-found condition of the machine to as-designed specifications, and quantify both the level of risk that a part may fail mechanically, and the effects of performance degradation on power output and efficiency. Then, working with the customer, GE can use this information with the customer's intimate knowledge of the operating history of the unit to:

- Recommend parts replacement to maintain high levels of reliability
- Quantify the direct impact of performance degradation on fuel costs or purchased power, to determine if parts replacement is warranted based on these direct dollars for fuel or power recovery

### Reliability Improvement

Steam turbine buckets are particularly sensitive to time-dependent aging effects. Fatigue and creep both contribute to bucket damage that may lead to catastrophic failure in the machine. When a bucket fails in operation, metal pieces are often sent downstream through the steam path, and cause significantly more damage than the single failure.

Over time, bucket profiles may erode as steam is constantly wearing over the surfaces. As the mass of the buckets change due

to the removal of material, natural frequencies can shift and put the bucket into a resonant vibration mode in the operating range, leading to bucket failure. The converse can also be true if deposits form on the buckets. In this case the addition of mass can shift the natural frequencies into a possible resonant condition.

As part of a life extension study, GE can analyze the existing stages of a machine, and determine if any stage is marginal compared to the latest standards for GE designs. By utilizing IDS, GE is able to accurately predict stage loading, and specific stage pressures and temperatures. This capability puts GE in a position to be able to determine thermodynamic conditions over a range of operating conditions, and to calculate bucket loading as part of the total turbine system.

Over the decades, analysis techniques have improved and operating experience has led to changes in design acceptability. It is not uncommon for designs from the 1940s through the 1960s to exceed today's modern acceptability limits. This does not necessarily mean that the machines are in immediate peril of failure, but merely that over the years, GE's conservative approach to ensuring maximum reliability through all possible operational conditions has made older designs obsolete. By coupling the results of a life extension study with prudent engineering judgment about how a machine has and will continue to be operated, GE and the customer can work together to determine which components are at greatest risk, and make recommendations to prevent future problems.

Recently a customer requested such an evaluation on the steam path for its unit. Analysis results showed that some of the existing stages of this 1950s–designed machine were marginal compared to new unit design standards. By comparing the operating history of the stages in question, it was found that indeed two of the stages had been problematic, and were recommended for replacement. Engineering deemed the other stages that exceeded new unit allowable stress levels were acceptable based on successful operating history, but noted that a careful inspection of these parts should be done at each outage.

Diaphragm erosion can also reduce the reliability of the buckets. As the trailing edge of the nozzles in the diaphragm is worn away over the years, the nozzle passing frequency changes. Drastic changes in the nozzle metal section can affect the first and second harmonics, leading to bucket resonance. Often, the performance degradation is

the only facet considered when diaphragms have eroded or have been cut back as a short term repair for chipping, but customers should take note that reliability can be compromised as well.

Stationary parts such as valve bodies, inner shells, and outer casings can be subject to aging also. Low cycle fatigue due to start-ups, shutdowns, and load changes can lead to cracking. Cracks will typically be seen at the webs between boltholes, at inlet and extraction snout locations, or at geometry transitions in the casings. Though weld repair is one option in dealing with such cracks, this does not restore the fatigue life of the remaining material, and subsequent cracking can be expected. This tends to be a maintenance nuisance, and leads to higher repair costs and possibly increased outage time. Cracking can be especially a problem with older design casings made from cast iron. Cast iron has very poor weld characteristics, and these components would be susceptible to further cracking due to inadequate repair. As part of a life extension program, GE can evaluate the condition of a customer's stationary component and make recommendations for replacement. Based on a customer's specific plans for extended operating life, or if changes from base loading to cyclic duty are expected, GE can make recommendations for replacement in-kind, or for a more robust design that can better withstand the thermal transients by changing material and geometric features in the design.

### Performance Recovery

Aging effects on turbine performance can be readily evaluated using the MST portion of the Integrated Design System. This stage-by-stage analysis method is so inclusive, that each individual packing ring is modeled in the calculation, as are all of the nozzles and buckets of each stage. As such, it is possible to incorporate as-found conditions into the model and determine the detriment on performance. A customer can then use this information to develop a cost model and payback algorithm that can be used to justify parts replacement. By checking the sensitivity of the turbine system to opened clearances, eroded or pitted nozzle surfaces, or eroded bucket profiles, the customer can selectively replace parts that will have the greatest payback for recovering efficiency and power output.

### Parts Replacement Planning

As already discussed, aging turbine components put the industrial customer at risk for decreased reliability, increased maintenance, and poor performance. By utilizing GE's advantage as the OEM, the

customer can quantify the level of risk for reliability problems, and use this data to economically plan parts replacement. Factors to consider are the economic consequences of a forced outage, increased outage duration due to maintenance nuisances, and loss of performance. GE's knowledge of the operating history of its entire fleet of turbines, its ability to analyze the entire system with IDS, and access to as designed manufacturing drawings and as-built quality records can be integrated into a value package offering to extend the useful life of a customer's machine.

## Advanced Seals Technology – Brush Seals

Turbine efficiency improvement is an important consideration of any steam turbine value package. Providing the most efficient design while assuring the upgrade or conversion meets or exceeds all performance guarantees and operates reliably is a key objective. When viewing the source of efficiency losses in a steam turbine, 33% of the total loss can be attributed to leakage.

These leakage losses are divided into tip leakage at 22%, shaft packing at 7% and root leakage at 4%. Clearly reducing efficiency loss due to seal leakage can have a significant impact on steam turbine performance. GE has developed advanced steam turbine brush seals that have been used on aircraft engines and gas turbines for a number of years. The continuing development work on these brush seals leverages effort on aircraft engines and industrial gas turbines with GE Global Research playing a central role. (See Figure 12.)

### IST Performance Benefit Analysis

Using the computerized industrial steam integrated design system, engineering calculated the performance benefit of brush seals on ten representative units (T/G set, mechanical drive, BFPT and STAG unit). Calculated improvements were based upon establishing equivalent clearances on each stage and comparing the results to the original packing with 10 mils radial clearance. This is expected to yield a conservative result as in actual practice most units momentarily rub on start-up or during operation resulting in additional radial clearance.

The location and benefit of the brush seals are shown in Table 2.

### Description of Brush Seal

A brush seal assembly consists of a front plate, the bristles and a backing plate. The plates are manufactured from 409 12Cr steel.

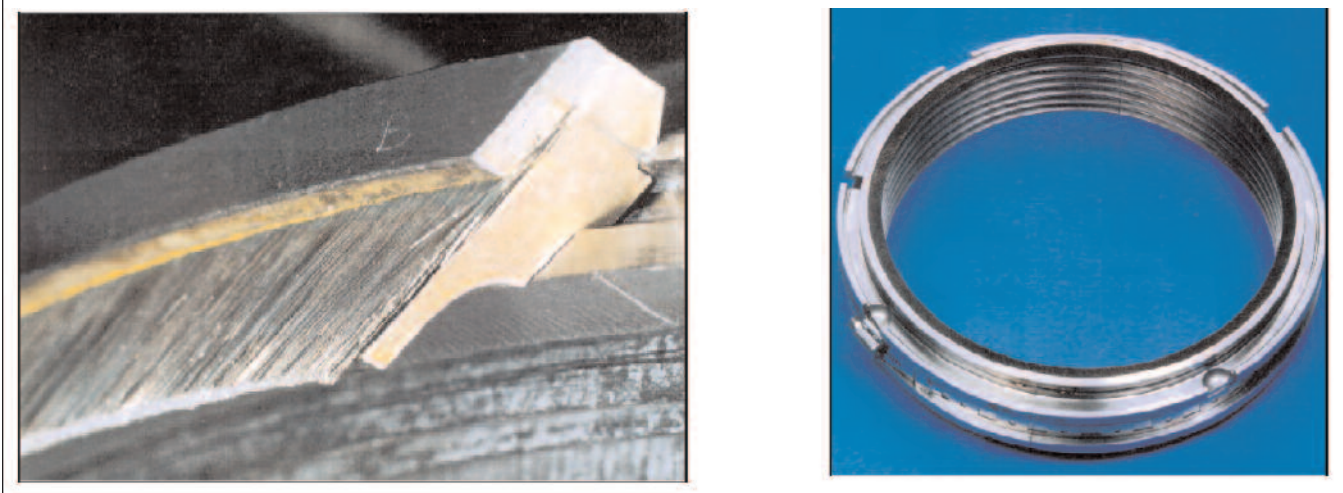

Figure 12. GE brush seal designs

Location	Benefit
Interstage Shaft Packing	0.2 – 0.4% efficiency gain
Bucket Tip	0.7 – 1.1% efficiency gain
Shaft End Seals	0.4 – 0.8% efficiency gain

Table 2. Location and benefit of brush seals

The bristles are manufactured from Haynes 25m, a cobalt steel. The bristles are welded in between the two plates and canted at an angle in the direction of rotation. The bristles at the end of each section are held in place by a welded in shim plate. The bristle diameter is a function of the location in the turbine and associated space constraints and pressure drop.

The bristle pack is inserted into a “T” groove machined into the neck of the packing ring. On industrial units, the labyrinth packing rings may be designed to function as both the front and back plates. The brush seal takes the place of only one or two labyrinth teeth. The rest of the labyrinth teeth remain acting as a back up seal.

For all straight labyrinth packing rings, rotor machining is not required. For a high low labyrinth tooth configuration, one rotor land must be machined off in order to provide sufficient axial space without bristle rub during transients.

### Design Considerations

Based upon GE’s brush seal development program and rotating test rig, the key design considerations have been identified in order to assure a reliable design. These include pressure drop and

associated seal capability, bristle stability, steam seal system self-sealing point, wear and material selection, rotor dynamic impact, segment end design and secondary leakage flows. Unless all of the parameters are taken into account it’s not possible to assure an effective long lasting design.

Understanding the impact of brush seals on turbine rotor dynamics is crucial to reliable operation. Contact between the rotor and the brush leads to frictional heating. Any initial bow in the rotor will lead to a high spot and can lead to a rotor bow due to differential heating. Interstage brush seals and those installed in the shaft ends have an impact on rotor critical speeds. The interstage seals tend to impact the first bending critical whereas the shaft end seals tend to impact the second bending critical.

The successful installation of shaft end brush seals requires understanding the relationship between the rotor’s critical speed characteristics and location and quantity of the brush seals installed. A Design For Six Sigma transfer function has been developed to quantify the relationship between rotor stiffness, critical speeds, brush seal contact force and bristle clearance. Thus each rotor and brush seal application must be analyzed before the brush seals are installed to assure that neither the 1st or 2nd critical speeds are excited.

The performance benefits for various applications of brush seals for industrial steam turbines have been reviewed along with the design issues that must be considered. GE is in a unique position of actually being able to accurately determine the impact of adding brush seals to a specific unit by utilizing the industrial steam integrated design system.

To date there are eight steam turbines running with a combination of interstage packing, end packing and bucket tip seals. These include both industrial steam turbines from 20 MW to large utility turbines of 900 MW. Drawing on the resources at the GE Global Research and GE – Aviation as well as at GE Energy, development continues to both refine the current design and to expand the range of possible applications.

## Advanced Seals Technology – Variable Clearance Positive Pressure Packing

### Description of Variable Clearance Positive Pressure Packing (VCPPP)

Variable clearance positive pressure packings look like conventional labyrinth seal packing rings except that the radial clearance changes as a function of load. VCPMP was developed to move away, or retract, from the rotor during start-up and shut down, resulting in relatively larger radial clearances to minimize heavy packing rubs associated with transient rotor thermal deflection or bowing. Tight clearances are present at higher loads to achieve maximum efficiency. VCPMP is offered for use on the interstage packings as well as end packings.

VCPPP rings have springs to provide the opening force to push the packing away from the rotor. After synchronization and as the unit is loaded and intra-stage pressure drops increase, the upstream steam is channeled into the area above the packing ring. The pressure forces overcome the spring and friction forces at the steam joint, and the rings close (retract) to the minimum clearance position. The amount of travel (retraction) is typically 0.060". VCPMP may be provided with the re-roundable feature built-in to allow radial adjustment of packing ring segments relative to the rotor. The modern design may feature small support bars on the lower half packing rings at the horizontal joint assuring reliable closure. This design avoids modifications to the packing heads or diaphragms by having the steam feed holes integral to the packing ring segments and the support bar design fits into the existing upper half slots for the retaining keys.

Detailed evaluations are performed by GE to determine which packing locations can benefit from and physically accommodate VCPMP.

### Benefits

Variable clearance positive pressure packing reduces the potential for rotor rubbing leading to excessive wear of the conventional packing ring teeth, and potential rotor damage and bowing. The

reduction in turbine efficiency due to increased radial clearance and decreased flow resistance because of altered tooth geometry is thus avoided. In addition, variable clearance positive pressure packing simplifies starting and loading because start-up rubs are avoided.

## Erosion Protection

### SPE-Resistant Stage 1 Nozzle Blades

Particle trajectory analysis of control stage nozzles has demonstrated that SPE is caused by high-velocity, low-angle impacts on the pressure side of nozzle partitions near the trailing edge. The calculated range of impact angles coincides with that which produces the maximum erosion rate in nozzle partition material. Erosion can be significantly reduced by use of special new "BattleShip" nozzle profiles especially designed to reduce the above erosion by high-velocity, low-angle impacts. *Figure 13* shows that the nozzle partitions have been reconfigured to reduce the number of particle impacts on the trailing edge pressure surface.

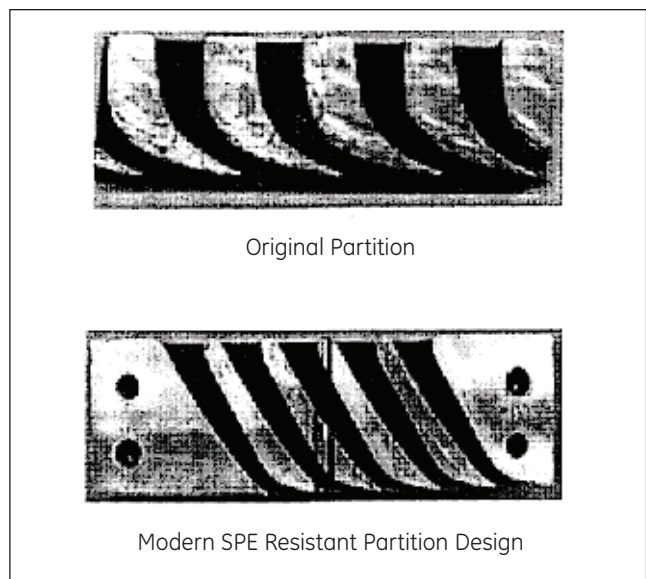

**Figure 13.** Comparison of nozzle profiles to minimize solid particle erosion

The new low-impact profiles shown below have been installed in over 120 GE large steam turbines with significant success.

### SPE Thermal Spray Coating on Stage 1 Buckets

Solid particle erosion (SPE) protection for the first stage buckets is also available. In this area, low impact geometries are not available to reduce SPE, so instead, a cermet-type coating applied by the High-Velocity Oxy-Fuel (HVOF) thermal spray technique is used.

Very hard materials such as cermets are much less susceptible to wear at low impingement angles and when used to coat the nozzle airfoil can offer protection from SPE.

The HVOF technique is used in applying the chromium carbide coating. A line of sight thermal spray process is used to apply a chromium carbide coating 8 to 12 mils thick. Coated high-pressure (HP) nozzles have more than 25 times the erosion resistance of unprotected 12Cr base metal sections. This results in reduced replacement costs, extended inspection intervals, reduced efficiency losses from SPE and sustained performance.

### Flame Hardened Last Stage Buckets

Modern GE LSBs are now flame hardened using a long-developed “automated” process. This process hardens the virgin bucket material itself for erosion protection and relies on no attached materials. For 12 Chrome buckets the process produces a minimum surface hardness of 375 Brinnell (40 Rockwell C) which is nearly the same as Stellite. But more importantly, the automated flame hardening can be performed over a broader surface area at the bucket tip, and can be completely hardened through the material (“through hardening”) as compared to the typical 0.050-inch thick Stellite strips. The automated flame hardening results in a low erosion and low maintenance system totally compatible with the buckets’ mechanical design requirements.

### All-Stainless Steel Diaphragms

The original design of many diaphragms featured stainless steel nozzle partitions and carbon steel rings and webs, which was the standard product offering at the time of manufacture. GE has many turbines operating with this design without mechanical problems.

For improved erosion and wear resistance of the outer ring and inner web, GE can offer replacement diaphragms with stainless steel outer ring and inner webs. For this material alternate, the entire diaphragm including outer ring, inner web, nozzle partitions, steam path sidewall bands and fabrication welds will all be stainless steel materials selected appropriately from the AISI 400 series of 12% Chrome alloys.

Diaphragms are subject to both mechanical erosion and a two-phase corrosion/erosion process. The corrosion/erosion phenomenon is the more prevalent and more insidious of the two. This process takes place in the following manner: In a single-phase environment with no flow, a protective oxide layer (magnetite) is formed. This layer is stable

in that the rate at which the oxide is forming is equal to the rate at which the layer is dissolving. If the fluid is put into motion, the solution becomes unstable because of the continual cleansing action of the fluid flow. The oxide forming flux is now exceeded by the dissolution flux and the protective layer is eventually lost.

In the two-phase flow, essentially the same mechanism exists, however, the process is exacerbated. In two-phase flow, the oxide layer can also be reduced by the mechanical impact of water droplets.

The rate at which this phenomenon takes place depends on the following parameters: moisture content, metal alloy content, temperature, oxygen level, pH level, and velocity. The most significant parameters are moisture content, alloy content, and temperature.

The material corrosion-erosion resistance is measured by sigma, the sum of chromium, copper and nickel. *Figure 14* presents an estimate of corrosion-erosion as a function of sigma for a constant velocity, temperature and moisture content. Increasing sigma reduces corrosion rate by making the oxide film more adherent and less susceptible to erosion.

### Z-Joint Diaphragms

Many existing diaphragm designs have straight-line horizontal joints that result in a segmented nozzle partition at each joint. (See *Figure 15*.) This type of joint can require frequent repair to deal with erosion problems. New design horizontal joints are available which

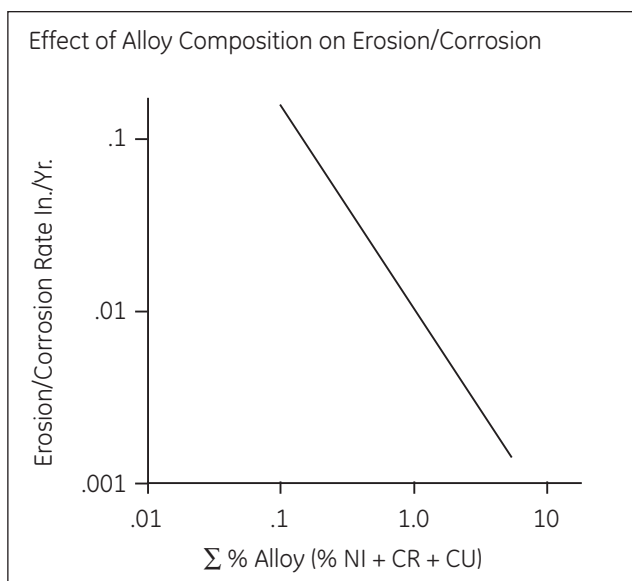

Figure 14. Effect of alloy composition on erosion rates



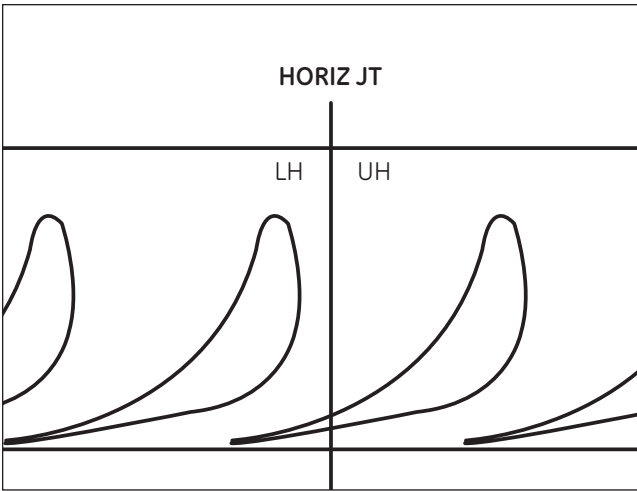

Figure 15. Existing design has split vane at joint

incorporate an enhanced design called a Z-joint. This design allows for an uninterrupted vane profile at each joint, thereby eliminating any potential crevice along the vane. (See Figure 16.)

**Shoot-Around Last Stage Diaphragms**

Modern GE diaphragm designs for tall last stage condensing buckets now utilize “ski jump” type outer spacer band designs and increased axial clearance to deflect moisture away from bucket tip regions. This shoot-around design greatly reduces direct water drop impact in the bucket tip. See Figure 17 for old vs. new generation designs.

Per Figure 17, the new generation diaphragms feature increased axial clearance from nozzle discharge to the bucket. This requires any water droplets to travel a longer distance, enabling the radial steam force and ski-jump spacer band to deflect moisture around the bucket tip. On a calculated basis (Figure 18) erosion is reduced

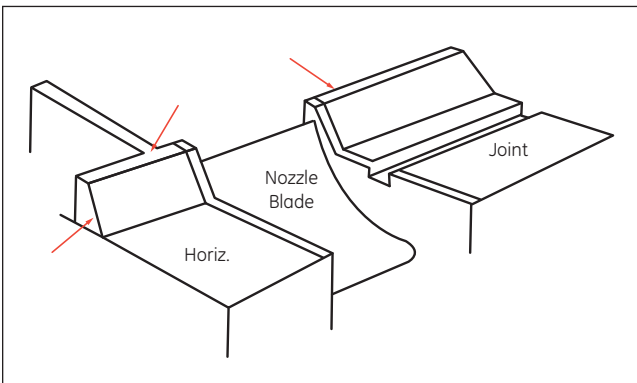

Figure 16. Enhanced design has Z-joint

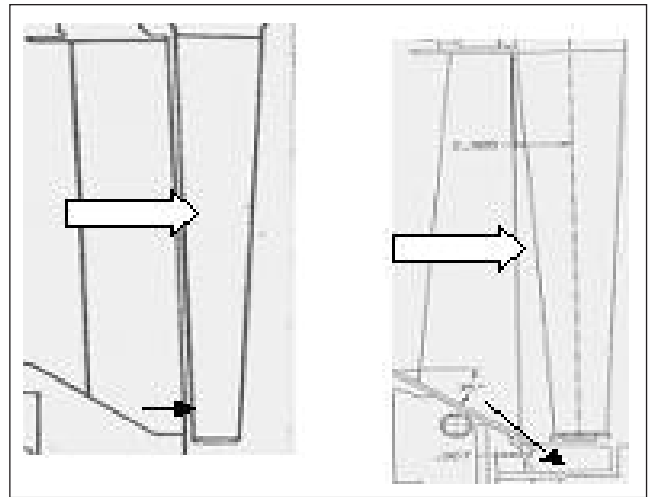

Figure 17. Old vs. new generation shoot-around diaphragm design

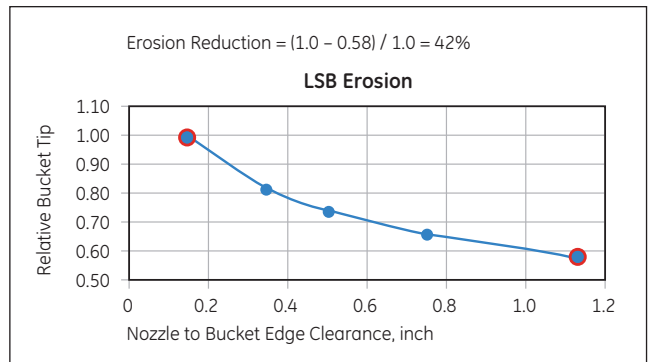

Figure 18. 20-inch LSB erosion reduction using new generation diaphragm

42% alone by use of the larger setback, ski-jump diaphragm vs. the original direct-impingement design of Figure 17.

**Future Efficiency Gains**

GE continually seeks to advance its technology in all product lines, and future improvements for the industrial steam turbine market will leverage efforts from GE’s development in utility steam turbines, gas turbines, aircraft engines, and at GE Global Research.

**Leveraging ADSP and Dense Pack™**

GE’s latest advances in steam turbine technology can be traced to the ADSP (Advanced Design Steam Path) and Dense Pack™ offerings for large utility machines. ADSP reflects an uprate package where the existing rotor is retrofitted with the latest bucket and diaphragm technology to give higher efficiency sections. The Dense Pack™ offering is a completely new approach to designing turbines. By starting from the mechanical limitations of the turbine, Dense Pack™

applies lowest shaft diameters to minimize leakage, increases the number of stages per section, and uses higher reaction levels to give peak section efficiency. ADSP uprates have been successfully installed in several GE units over the past decade, and Dense Pack™ has recently been installed in a handful of units with optimistic results. Due to implementing Design For Six Sigma methods, the design and analysis methods are becoming more streamlined and applications guidelines are being formulated to allow for faster evaluation of each customer's unit. Once these design rules and tools are firmly in place, GE can apply this technology to its other steam turbine products.

### STTV

As part of the testing and development of its steam turbine technology, GE has created the Steam Turbine Test Vehicle (STTV), in Lynn, Massachusetts. The STTV is fully instrumented to measure steam properties at nearly every location in the steam path. Though the development is primarily for the large utility machines, the STTV is actually a converted BFPT, and many of test results will transfer readily to the industrial steam turbine product line.

## Conclusion

GE has the experience to offer value package solutions to customer needs. Experience and technology have been presented that translate to offerings that directly aligns to customer needs for the entire product, rather than single components. Reliability, capacity, plant changes, and maintainability are all considered in the Value Pack offerings discussed. GE is also committed to further advancing the steam turbine technology, and constantly seeks to better serve its customer base.

## References

1. Beck, "Industrial Steam Turbine Upgrades," GER-3753B, GE Reference Library.
2. Cofer, J., Reinker, J. K., and Sumner, W.J., "Advances in Steam Path Technology," GER-3713E, GE Reference Library, August 1996.
3. Estabrook, J.E., and Leger, R.H., "Recent Advances in Steam Turbines for Industrial and Cogen Applications," GER-3706D, GE Reference Library, October 2000.
4. Leger, D., "Mechanical Drive Steam Turbines," GER-3768A, GE Reference Library, August 1996.

## List of Figures

- Figure 1. GE industrial steam turbine experience
- Figure 2. Evolution of cylindrical blade designs
- Figure 3. HP Val-Pak new technology offering
- Figure 4. 3D 20-inch last stage bucket and diaphragm
- Figure 5. Improved nozzle design
- Figure 6. Conical sidewall diaphragm construction
- Figure 7. Screenshot of Viewdes database menu
- Figure 8. Screenshot of MST bucket detail screen
- Figure 9. Extraction map extrapolation
- Figure 10. Sketch of bearing with partial arc valve forces for each valve point. Vector magnitudes are to scale relative to each other.
- Figure 11. Comparison of original and improved nozzle box packing designs
- Figure 12. GE brush seal designs
- Figure 13. Comparison of nozzle profiles to minimize solid particle erosion
- Figure 14. Effect of alloy composition on erosion rates
- Figure 15. Existing design has split vane at joint
- Figure 16. Enhanced design has Z-joint
- Figure 17. Old vs. new generation shoot-around diaphragm design
- Figure 18. 20-inch LSB erosion reduction using new generation diaphragm

## List of Tables

- Table 1. Successful refurbished turbine application
- Table 2. Location and benefit of brush seals





