



GE Power Systems

***Economic and Technical
Considerations for
Combined-Cycle
Performance-Enhancement
Options***

Chuck Jones
John A. Jacobs III
GE Power Systems
Schenectady, NY

Contents

Abstract	1
Introduction	1
Economic Evaluation Technique	2
Output Enhancement	3
<i>Gas Turbine Inlet Air Cooling</i>	3
<i>Evaporative Cooling</i>	4
<i>Evaporative Cooling Methods</i>	4
<i>Evaporative Cooling Theory</i>	4
<i>Wetted-Honeycomb Evaporative Coolers</i>	5
<i>Water Requirements for Evaporative Coolers</i>	6
<i>Foggers</i>	8
<i>Evaporative Media and Inlet Fogging Comparison</i>	10
<i>Evaporative Media</i>	10
<i>Inlet Fogging</i>	10
Evaporative Intercooling	10
<i>Inlet Chilling</i>	11
<i>Inlet Chilling Methods</i>	12
<i>Off-Peak Thermal Energy Storage</i>	13
<i>Comparison of Direct Chilling and Thermal Energy Storage</i>	13
<i>LNG/LPG Gas Vaporizers</i>	13
Power Augmentation	13
<i>Gas Turbine Steam/Water Injection</i>	13
<i>Supplementary Fired HRSG</i>	14
<i>Peak Firing</i>	15
<i>Output Enhancement Summary</i>	15
Efficiency Enhancement	15
<i>Fuel Heating</i>	15
Performance-Enhancement Case Study	16
<i>Assumptions/Base Plant Description</i>	17
Description of Methods	17
Discussion	21
<i>HRSG Duct Firing</i>	21
<i>Gas Turbine Inlet Fogging/Evaporative Cooling</i>	22
<i>Gas Turbine Inlet Chilling</i>	22
<i>Results</i>	23

<i>HRS</i> G Duct Firing	26
<i>Gas Turbine Inlet Air Fogging</i>	26
<i>Gas Turbine Evaporative Cooling</i>	27
<i>Gas Turbine Inlet Air Chilling</i>	27
Conclusion	27
References	28
Glossary	28
<i>Economic Terms</i>	28
<i>Other Terms</i>	29
List of Figures	30
List of Tables	30
List of Exhibits	30

Abstract

Over the past several years tumultuous, revolutionary and widespread changes have occurred within the U.S. power generation industry. Deregulation, linked with declining reserve margins and climatic temperature extremes has resulted in new economic plant-operation considerations for owners of existing power plants and developers of new power plants.

A sustained increase in summer peak period power demands and peak period duration combined with escalation of peak energy rates ($\$/kWh$) have encouraged owners and operators of existing plants and developers of combined-cycle power plants to seek power-enhancing alternatives for optimizing plant performance and revenue streams.

Various methods are available for improving the performance of combined-cycle power plants during initial plant design or as uprate opportunities. Improvements can be made in plant output or efficiency beyond those achievable through higher steam temperatures, multiple steam-pressure levels or reheat cycles. For example, it has become commonplace to install gas fuel heating on new combined-cycle power plants to improve plant efficiency. Additionally, gas turbine inlet air cooling is sometimes considered for increasing gas turbine and combined-cycle output.

A variety of options available for enhancing combined-cycle performance (primarily plant output) exists; this paper presents a technical description of each alternative, outlines the relative performance benefits of each enhancement alternative and discusses the potential economic valuation of the alternatives and combination of alternatives.

Given the large volume of GE, 7FA (PG7241FA) gas turbine sales over the last several years and

sales commitments for the next several years, coupled with an expectation that many of these will be configured as STAG 207FA (two gas turbines and one steam turbine) combined-cycle plants, the economic assessment of performance-enhancement alternatives is presented in the form of a case study for a STAG 207FA combined-cycle plant configuration.

Introduction

Plant output and efficiency are carefully considered during the initial plant design because they impact the cost of electricity in combination with fuel costs, plant capital cost, cost of capital and electricity sales. These factors will drive the gas turbine selection as well as the bottoming cycle design in combined-cycle operation. As fuel costs increase, cycle selections typically include higher steam pressures, multiple steam pressure levels, reheat cycles and higher steam temperatures. Once these selections have been made, other factors are addressed. Is there a need for peak power production with premiums paid for the resulting power? If so, gas turbine power augmentation by way of water or steam injection or a supplementary fired heat recovery steam generator (HRSG) may be the solution. Do peak power demands occur on a hot day (summer peaking)? This may suggest a potential benefit from some form of gas turbine inlet evaporative cooling or chilling.

For existing plants, some performance-enhancement options can also be economically retrofitted to boost power output and efficiency. Although this paper's primary focus is on options that enhance output, a brief discussion of fuel gas heating, which is a technique used to enhance combined-cycle plant efficiency, is provided.

The ability of utilities and independent power producers (IPPs) to generate additional power

beyond a plant's base capacity during summer peak power demand periods has become an important consideration in the design of combined-cycle plant configurations. In recent years, utilities and IPPs within the United States have received premiums for power generation capacity during summer peak power demand periods. *Figure 1* depicts one plausible scenario for the price of electricity ($\text{\$/kWh}$) as a function of annual operating hours. It should be noted that curves like this one are highly regional dependent. With price-duration curves such as this, the majority of a plant's profitability could be driven by the high peak energy rates that can be achieved over a relatively short period of time. Thus, a plant that can economically dispatch a large quantity of additional power could realize the largest profits.

While current market trends such as the one depicted in *Figure 1* should be considered during the design and development phase of a combined-cycle facility, forecasts of future market trends and expectations are equally important and warrant design considerations.

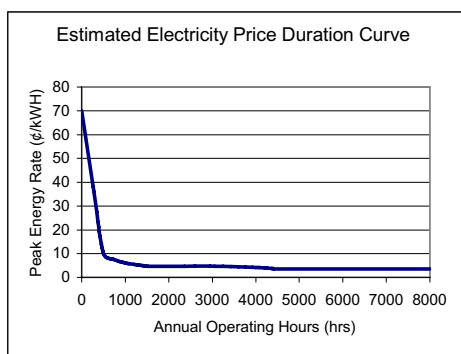

Figure 1. Potential peak energy rate variation as a function of operating hours

One of the primary challenges facing developers of new combined-cycle plants, as well as owner/operators of existing plants, is the optimization of plant revenue streams. As a result of escalating peak energy rates and peak demand

duration, significant emphasis has been placed on developing plant designs that maximize peak power generation capacity while allowing for cost-effective, efficient operation of the plant during non-peak power demand periods. In addition to maximizing plant profitability in the face of today's marketplace, expectations of future market trends must be considered.

Economic Evaluation Technique

From an economics perspective this paper will qualitatively explore the potential revenue stream trade-off between a combined-cycle plant without performance enhancements to the same plant if it were to include a performance-enhancement option or a combination of options. Our goal is to determine which performance-enhancement options or combination of options can be applied to a new or existing combined-cycle plant to maximize total plant profits on a plant life-cycle basis. A glossary of economic terms referenced in this text appears at the end of this paper.

With very few exceptions, the addition of power-enhancement techniques to a base plant configuration will impact baseload performance negatively and, hence, affect a plant's net revenue generating capability adversely during nonpeak periods. *Figure 2* is an exaggerated

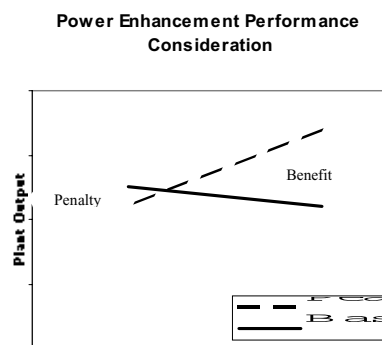

Figure 2. Plant performance trends

graphic representation of this concept. In general, efficiency is the predominate economic driver during non-peak generating periods, while capacity dominates the economic evaluation during peak power demand periods. Thus, it is extremely important to develop an economic model that considers both the cost of electricity (COE) during non-peak periods while taking into consideration expectations of peak energy rates.

After having established baseline peak and non-peak period performance levels for the various power-enhancement alternatives, a COE analysis technique is applied to determine alternatives that would afford the best overall life-cycle benefit. In addition to including both peak and non-peak performance levels, the COE model includes the split between annual peak and non-peak operating hours, the premium paid for peak power generation capacity, the cost of fuel, plant capital cost, the incremental capital cost of the enhancements and the cost to operate and maintain the plant. This COE model is then used to determine the sensitivity of a given power-enhancement alternative with respect to the economic parameters included within it.

Most peak power enhancement opportunities exist in the topping cycle (gas turbine) as opposed to the bottoming cycle (HRSG/steam turbine). In general, with the exception of duct firing within the HRSG, there are few independent design enhancements that can be made to a bottoming cycle that has already been fully optimized to achieve maximum plant performance. However, in general, performance enhancements to the gas turbines will carry with them an increase in bottoming cycle performance due to an associated increase in gas turbine exhaust energy.

Output Enhancement

Plant output enhancements can be categorized

further into two major categories: gas turbine inlet cooling and power augmentation.

Gas Turbine Inlet Air Cooling

For applications where significant power demand and highest electricity prices occur during the warm months, a gas turbine air inlet cooling system is a useful option for increasing output. Inlet air cooling increases output by taking advantage of the gas turbine's characteristic of higher mass flow rate and, thus, output as the compressor inlet temperature decreases.

Industrial gas turbines that run at constant speed are constant-volume-flow machines. The specific volume of air is directly proportional to the temperature. Because the cooled air is denser, it gives the machine a higher air mass flow rate and pressure ratio, resulting in an increase in output. In combined-cycle applications there is also a small improvement in thermal efficiency.

Figure 3 shows that a 10°F (5.6°C) reduction in gas turbine inlet dry-bulb temperature for heavy-duty gas turbines improves combined-cycle output by about 2.7%. The actual change is somewhat dependent on the method of steam turbine condenser cooling being used. Simple-

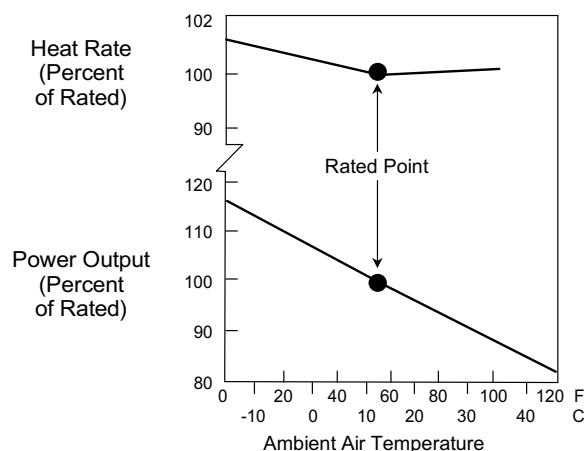

Figure 3. Combined-cycle system performance variation with ambient air temperature

cycle output is improved by a similar percentage. Several methods are available for reducing gas turbine inlet temperature. There are two basic systems currently available for inlet cooling. The first and perhaps the most widely accepted system is evaporative cooling. Evaporative coolers make use of the evaporation of water to reduce the gas turbine's inlet air temperature. The second system employs various ways to chill the inlet air. In this system, the cooling medium (usually chilled water) flows through a heat exchanger located in the inlet duct to remove heat from the inlet air. Evaporative cooling is limited by wet-bulb temperature. Chilling, however, can cool the inlet air to temperatures that are lower than the wet-bulb temperature, thus providing additional output albeit at a significantly higher cost. Depending on the combustion and control system, evaporative cooling may reduce NO_x emissions; however, there is very little benefit to be gained from current dry low NO_x technology.

In the case of uprates and new unit designs, even though the compressor inlet temperature is reduced, the temperature of the cooling air to the generator, transformer, cooling air cooler (if applicable) and lubricating oil cooler is not reduced. Calculations must be performed to determine if these components can handle the increased power and loads at the elevated temperatures.

Evaporative Cooling

Evaporative cooling is a cost-effective way to add machine capacity during warm weather when peaking power periods are usually encountered on electric utility systems, provided the relative humidity is not too high.

Evaporative Cooling Methods

There are two basic systems for achieving evaporative cooling. The first uses a wetted-honey-

comb type of medium and is typically referred to as an evaporative cooler. The second system is known as an inlet fogger.

Evaporative Cooling Theory

Evaporative cooling works on the principle of reducing the temperature of an air stream through water evaporation. The process of converting the water from a liquid to a vapor state requires energy. This energy is drawn from the air stream. The result is cooler, more humid air. A psychrometric chart (*Figure 4*) is useful in exploring the theoretical and practical limitations of evaporative cooling.

Theoretically, the minimum temperature that can be achieved by adding water to the air is equal to the ambient wet-bulb temperature. Practically, this level of cooling is difficult to achieve. The actual temperature drop realized is a function of both the equipment design and atmospheric conditions. Other factors being constant, the effectiveness of an evaporative cooling system depends on the surface area of water exposed to the air stream and the residence time. The effectiveness of the cooler is a function of its design and is defined as follows:

$$\text{Cooler effectiveness} = \frac{T1_{DB} - T2}{T1_{DB} - T2_{WB}}$$

- 1 refers to entering conditions.
- 2 refers to exit conditions.
- DB equals dry-bulb temperature.
- WB equals wet-bulb temperature.

Typical effectiveness levels are 85 to 95%.

Assuming the effectiveness is 85%, the temperature drop can be calculated by:

$$\text{Temperature drop} = 0.85 (T1_{DB} - T2_{WB})$$

As an example, assume that the ambient temperature is 100°F (37.8°C) and the relative humidity is 32%. Referring to *Figure 4*, which is a simplified psychrometric chart, the corre-

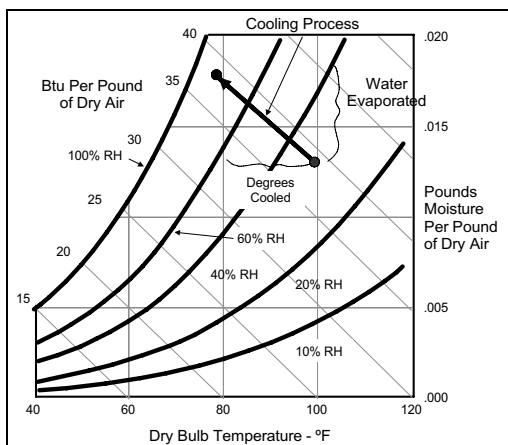

Figure 4. Psychrometric chart, simplified

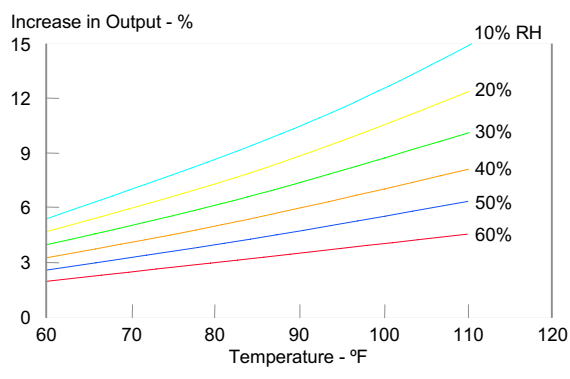

Figure 5. Effect of evaporative cooler on available output – 85% effective

sponding wet-bulb temperature is 75°F (23.9°C). The air temperature drop through the cooler is then 0.85 (100–75), or 21°F (11.7°C) (equals a compressor inlet temperature of 79°F [26°C]). The cooling process follows a line of constant enthalpy as sensible heat is traded for latent heat by evaporation.

The effectiveness of evaporative coolers is typically 85% and of foggers somewhat higher at 90 to 95%.

The exact increase in power available from a particular gas turbine as a result of air cooling depends upon the machine model and site altitude, as well as on the ambient temperature and

humidity. However, the information shown in Figure 5 can be used to make an estimate of this benefit for evaporative coolers. As would be anticipated, the improvement is greatest in hot, dry weather.

Wetted-Honeycomb—Evaporative Coolers

Conventional media types of evaporative coolers use a wetted honeycomb-like medium to maximize evaporative surface area and cooling potential. For gas turbines, the medium is typically 12 or more inches thick and covers the entire cross-section of the inlet air duct or filter house. The media and drift eliminator result in a pressure drop in the inlet air duct. Typical values are approximately one inch of water column. This increase in inlet pressure drop decreases the plant output and efficiency for all ambient temperatures and loads even when the system is off. The result is a 0.35% reduction in gas turbine baseload output and a 0.3% reduction in combined-cycle output. The combined-cycle output effect is less because the reduced gas turbine airflow is somewhat counteracted by a small increase in gas turbine exhaust temperature. Heat rate increases are modest at 0.12% and 0.04% for gas turbine and combined cycle, respectively. Retrofit installation often requires substantial ducting modifications. The effectiveness of the system is fixed by the media selection and condition so the inlet air temperature can not be controlled—the system is either on or off. This is not typically an issue because the operator desires the maximum possible increase in plant output. A typical self-cleaning filter/evaporative cooler design is shown in Figure 6. Water is pumped from a tank at the bottom of the module to a header, which distributes it over the media blocks. These are made of corrugated layers of fibrous material with internal channels formed between layers. There are two alternating sets of channels, one

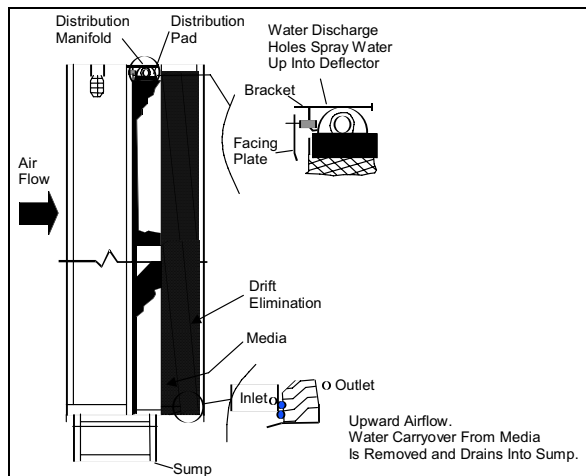

Figure 6. Media pack cooler design

for water and one for air. This separation of flows is the key to reducing carryover. Drift eliminators are installed downstream of the media to protect against the possibility of water carryover. The water flows down by way of gravity through the water channels and diffuses throughout the media through wicking action. Any excess returns to the tank. The level of water in the tank is maintained by a float valve, which admits makeup water.

A controller is provided that regulates the operation to a minimum ambient dry-bulb temperature. The minimum temperature must be 60°F (15.6°C) or higher. If evaporation were permitted at too low a temperature, this could cause icing. When there is a possibility that the dry-bulb temperature will fall below freezing, the whole system must be deactivated and drained to avoid damage to the tank and piping and the possibility that the porous media would plug with ice.

Water Requirements for Evaporative Coolers

Evaporative coolers are most efficient in arid regions where the water may have a significant

percentage of dissolved solids. If makeup water is added in sufficient quantity to replace only the water that has been evaporated, the water in the tank (which is also the water pumped to the media for evaporation) will gradually become laden with more minerals. In time, these minerals would precipitate out on the media and reduce evaporation efficiency. This would increase the hazard of some minerals becoming entrained in the air and entering the gas turbine. In order to minimize this hazard, water typically is bled continuously from the tank to keep the mineral content diluted. This is termed blowdown.

The amount of makeup water, which must be provided, is the sum of evaporation and blowdown. The rate at which water evaporates from a cooler depends upon the ambient temperature and humidity, the altitude, cooler effectiveness and the airflow requirement of the gas turbine. Figure 7 shows the evaporative water requirement of an 85% effective MS6001(B) gas turbine cooler at sea level. The corresponding value for an MS7001 or MS9001 machine can be estimated by respectively doubling or tripling the quantity shown.

One of the main concerns in determining the acceptability of water quality is its propensity to

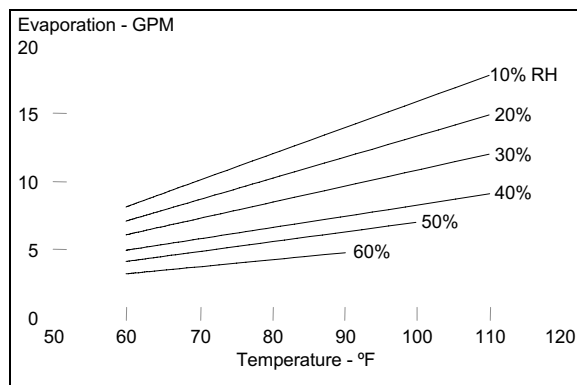

Figure 7. Evaporation rate for MS6001(B) – 85% effective

Steam Turbines for Industrial Applications

deposit scale. Scaling is influenced by the interaction of the water's total hardness, total alkalinity (ALK), total dissolved solids (TDS), pH and water temperature. To assist in determining whether the water is suitable for use in evaporative coolers, a saturation index (SI) is typically used.

A standard laboratory analysis of the water can determine the total hardness (ppm as CaCO_3), total alkalinity (ppm as CaCO_3), total dissolved solids (ppm) and pH. The levels of the first three components are first modified by an adjustment factor W :

$$W = (1/B + 1)(1/F + 1),$$

where

$F = \text{flood factor} = (\text{water drain rate from media to tank}) / (\text{water evaporation rate})$

and

$B = \text{blowdown factor} = (\text{water bleed rate from tank}) / (\text{water evaporation rate}).$

Water evaporation rate can be estimated by using the information in *Figure 7*.

In most cases, F and B are adjusted during installation to be approximately uniform on a typical hot day so that W equals 4. However, to make low-quality water more suitable, an increased blowdown rate may be used to lower the adjustment factor. Flood factor should not be adjusted to compensate for water quality because this could result in liquid water carry-over.

The ppm of TDS, ALK and hardness are multiplied by the adjustment factor to obtain ppm (adjusted). To evaluate the suitability of water for evaporative coolers, a modified Langlier saturation index chart is used (*see Figure 8*). The adjusted total alkalinity (ppm as CaCO_3) is converted to PALK, and the adjusted total hardness (ppm as CaCO_3) is converted to PCA by enter-

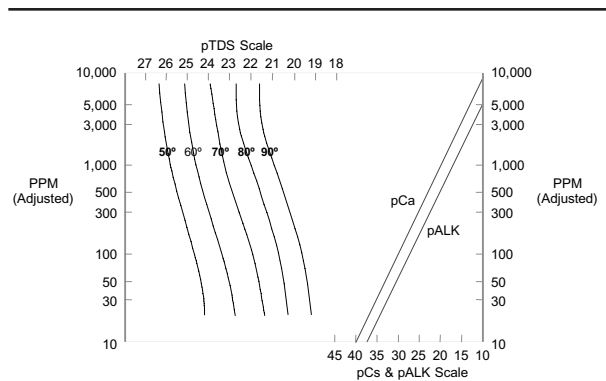

Figure 8. Langlier saturation index chart

ing the chart on the right-hand ordinate and reading the appropriate quantity from the right-hand abscissa. The adjusted total dissolved solids are converted to PTDS by entering the left ordinate, selecting the appropriate water temperature (which may be taken to be the wet-bulb temperature) and reading the upper-left abscissa.

$\text{Saturation index (SI)} = \text{pH} - \text{PCA} - \text{PALK} - \text{PTDS}$

$\text{SI} < 1.0$ indicates no water treatment is required.

Water treatment may be used to control any property or combination of properties to reduce SI to 1.0 or less. Initially, the blowdown rate is adjusted to be approximately the same as the evaporation rate on a typical hot day; this may later be adjusted based on operational experience and local water quality.

Even though care may be taken with water quality, the media eventually will have to be replaced as material precipitates out in sufficient quantity to impair its effectiveness. However, experience indicates that this may take quite a long time. At one site there has been operation for six seasons under adverse conditions with insignificant performance degradation. It is expected that the media will continue to be used for at least two more years. While this is

believed typical, the estimate may change as more experience is gained.

Tests indicate that the feedwater may have high levels of sodium and potassium without significant carryover of these metals into the gas turbine. However, very careful attention to detail is necessary in order to realize this level of performance. This includes proper orientation of the media packs, correct flows of air and water, uniform distribution of water over the media surface and proper drainage back to the tank. Any deficiencies in these areas may make it possible for water to become entrained in the air, with potentially serious results. Consequently, installation and maintenance of evaporative cooling equipment is very important. In areas where the water exceeds 133 ppm sodium and potassium, it is good practice to periodically check the rate at which these elements enter the gas turbine by means of a mass balance calculation. Any discrepancies between the rate at which sodium and potassium enter in the feedwater and the rate at which they leave in the blowdown can be attributed to carryover. Concentration of these elements in the inlet air should typically be held to 0.005 ppm or less. For example, this is equivalent to an ingestion rate of 0.01 lb/h for an MS7001 gas turbine.

When media types of coolers were first placed in service, some units exhibited unacceptable carryover. It was found that this problem had three possible causes: damaged or improperly installed media, entrainment of water from the distribution manifold or local areas of excessively high velocity through the media. The first cause was removed by new procedures for shipping and installing the media blocks. Carryover from the manifold was eliminated by installing blanking plates downstream of the spray elements. The third problem, high-flow velocity through portions of the media, was the most difficult to solve. After considerable effort, two

solutions were developed. The first incorporated features in the design to force more uniform flow so that velocities everywhere were within the acceptable range. The second solution involved a new design that accepted some carryover from the media but that eliminated carryover into the gas turbine by use of eliminator blades, similar to the vanes of a moisture separator, immediately downstream of the evaporative media. Both approaches have proven successful in the field and both approaches are now taken together to ensure no water carryover.

Foggers

Foggers were first applied to gas turbine inlet air cooling in the mid-1980s. Nearly 100 fog systems are installed on turbines in North America, from aeroderivatives to large-frame machines. Fog systems create a large evaporative surface area by atomizing the supply of water into billions of super-small spherical droplets. Droplet diameter plays an important role with respect to the surface area of water exposed to the airstream and, therefore, to the speed of evaporation. For instance, water atomized into 10-micron droplets yields 10 times more surface area than the same volume atomized into 100-micron droplets.

For evaporative cooling or humidification with atomized water, it is important to make a true fog, not a mist. To a meteorologist, water droplets of less than 40 microns in diameter make up a fog. When droplet sizes are larger than this, they are called a mist. True fogs tend to remain airborne due to Brownian movement—the random collision of air molecules that slows the descent of the droplets—while mists tend to descend relatively quickly. In still air, for example, a 10-micron droplet falls at a rate of about one meter in five minutes, while a 100-micron droplet falls at the rate of about one meter in three seconds.

Fogger nozzles (Figure 9) should be installed downstream of the inlet air filters. The determination of whether or not the nozzles should be installed upstream or downstream of the silencers depends upon the time available for the water to fully evaporate before the moist air encounters the next fixed object in the system (silencers, trash screen or inlet bellmouth). Retrofit installation times of one to two outage days have been quoted by manufacturers for some high-pressure water systems and require only minor modifications to the turbine inlet structures. Some water will condense or coalesce out as it travels down the inlet duct. To prevent this water from collecting in the inlet duct, a drain line needs to be installed downstream of the fog nozzles.

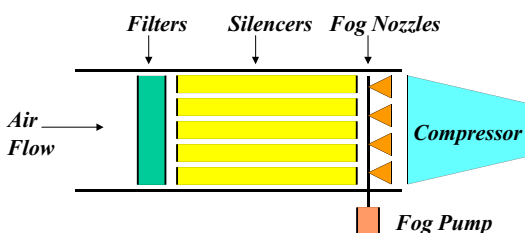

Figure 9. Fogger system

When considering a particular fog system design, give special attention to the fog nozzles and nozzle manifolds to avoid the possibility of small parts breaking off and becoming ingested by the turbine. Vibration caused by airflow across the manifolds should be considered, as well. If the manifolds are not properly designed or if they are improperly supported, vibration could eventually lead to structural failure of the manifolds or mounting brackets.

To minimize the potential of compressor fouling or nozzle plugging, demineralized water is used in high-pressure fog installations. The water requirements are the same as those for

gas turbine water-injection systems. Reports of fouling or plugging came only from plants where demineralized water was not in use or where the water supply systems were improperly maintained. Demineralized water makes it necessary to use high-grade stainless steels for all wetted parts. The usual nozzle manifold consists of half-inch-diameter tubes, spaced 8 to 12 inches apart. Because such an open latticework of small pipes does not impede the flow of air, the fog nozzle pressure drop is negligible.

There are several different methods of water atomization that can be employed. Some systems use gas turbine compressor air in nozzles to atomize the water. Other systems pressurize the water using high-pressure pumps that force the water through a small orifice. Air-atomized nozzles require less water pressure but suffer from lower generator output because of the air extraction from the gas turbine and inlet heating from the warm compressor air. Typical air-to-water ratios are 0.6 to 1 by mass (500 to 1 by volume). Some of the high-pressure pumped systems force the water to swirl, which causes it to break up into small droplets. Others force the water to impact on a pin, causing the same effect. For pressurized water systems, droplet size is inversely proportional to the square root of the pressure ratio. Doubling the operating pressure results in a droplet that is about 30% smaller. Typical operating pressures for high-pressure pumped-fog systems range from 1,000 to 3,000 psi.

A typical pressurized water fog system consists of a series of high-pressure pumps, a control system and an array of tubes containing the fog nozzles. The pump skid normally consists of several high-pressure pumps, each connected to a fixed number of fog nozzles. With this arrangement, each pump and its associated nozzles represent one discrete stage of fog cooling. The

pumps can then be turned on sequentially as the demand for cooling increases. For example, with four stages, a temperature drop of 20°F (11.2°C) is managed in 5°F (2.8°C) increments. If a finer increment of temperature reduction is desired, more stages can be included. It is important to distribute the fog nozzles for each stage evenly over the cross-section of the duct so that temperature gradients are minimized. Careful control of foggers is required to avoid excessive water carryover to the compressor.

The capacity of existing plant facilities for demineralizing and storing water needs to be evaluated when this system is retrofitted on existing plants to ensure that sufficient water will be available to meet the projected demand

Evaporative Media and Inlet Fogging Comparison

The following list highlights some of the important advantages and disadvantages of the two main types of inlet cooling.

Evaporative Media

Advantages

- Water quality requirements are less severe than fogger system.
- Simple and reliable
- More operating experience

Disadvantages

- Upgrades frequently require substantial duct modifications.
- Higher gas turbine inlet pressure drop than fogger system degrades output and efficiency when not in use
- Lower cooling effectiveness

Inlet Fogging

Advantages

- Gas turbine inlet pressure drop is lower than that of evaporative media and provides increased output.

- Potential for higher effectiveness than evaporative media
- Potential for lower uprate costs and faster installation time due to reduced duct modifications compared to evaporative media

Disadvantages

- Requires demineralized water.
- Higher parasitic load than evaporative media for high-pressure pumped systems
- Lower power increase for air-atomized systems
- Controls are more complex.

Evaporative Intercooling

Evaporative intercooling, also called overspray or overcooling, can be accomplished by purposefully injecting more fog into the inlet airstream than can be evaporated with the given ambient climate conditions. The airstream carries unevaporated fog droplets into the compressor section. Higher temperatures in the compressor increase the moisture-holding capacity of air, so the fog droplets that did not evaporate in the inlet air duct do so in the compressor. When the fog evaporates, it cools, making the air denser. This increases the total mass flow of air through the gas turbine and reduces the relative work of compression, giving an additional power boost. Fog intercooling allows turbine operators to get power boosts that are greater than would be possible with a conventional evaporative cooling system.

The limits of fog intercooling have not been fully investigated, but the benefits claimed are substantial. Theoretically, it is possible to inject enough fog to cause a power boost that is as high as that obtained by inlet air chilling below the wet-bulb temperature and at a fraction of the cost. This remains to be seen. There is one

possible drawback to intercooling: if water droplets are too large, there is a potential for liquid-impaction erosion of the compressor blading. Bombardment of a metal surface with water droplets can lead to the development of microfractures in the metal's surface and can cause surface pitting.

Intercooling can also be accomplished by fog spraying atomized water between compressor sections in gas turbines, which have high- and low-pressure compressors. The GE LM6000 SPRINT™ system is one example of such a system. Water is injected through 24 spray nozzles located between the high-pressure and low-pressure compressors on the two-shaft LM6000 (Figure 10). Water is atomized to a droplet diameter of less than 20 microns using high-pressure air taken from the eighth-stage bleed. Injecting water significantly reduces the compressor outlet temperature, and this allows the turbine to operate at the natural control limit associated with firing temperature rather than the compressor outlet temperature limitation. The result is higher output and better efficiency. Output increases of more than 20% and efficiency increases of 3.9% are possible on 90°F (32°C) days

The LM6000, when compared to some frame machines, has a steeper lapse rate—the rate at

which output decreases with increased air temperature—so the LM6000 has typically been applied with chiller technology. The SPRINT™ technology allows the operator to recover most of the power lost on hot days without incurring the capital and operating costs of chillers. SPRINT™ retrofit kits are available for existing LM6000 machines. Investigations are under way to find a way to utilize spray intercooling for the LM6000's low-pressure compressor section.

Before evaporative intercooling can be applied, the gas turbine component maximum load limitations and control algorithms must be carefully reviewed to ensure that design limitations are not exceeded. The same review must be conducted for the generator, steam turbine and auxiliary systems.

Inlet Chilling

The two basic categories of inlet chilling systems are direct chillers and thermal storage. Liquefied natural gas (LNG) systems take advantage of the fuel supply, utilizing the cooling effect associated with the vaporization of liquefied gas. Thermal storage systems take advantage of off-peak power periods to store thermal energy in the form of ice to perform inlet chilling during periods of peak power demand. Direct chilling systems use mechanical or absorption chilling. All are candidates for new plants or plant retrofits.

As with evaporative cooling, the actual temperature reduction from a cooling coil is a function of equipment design and ambient conditions. Unlike evaporative coolers, however, cooling coils are able to lower the inlet dry-bulb temperature below the ambient wet-bulb temperature. The actual temperature reduction is limited only by the capacity of the chilling device, the effectiveness of the coils and the compressor's acceptable temperature/humidity limits.

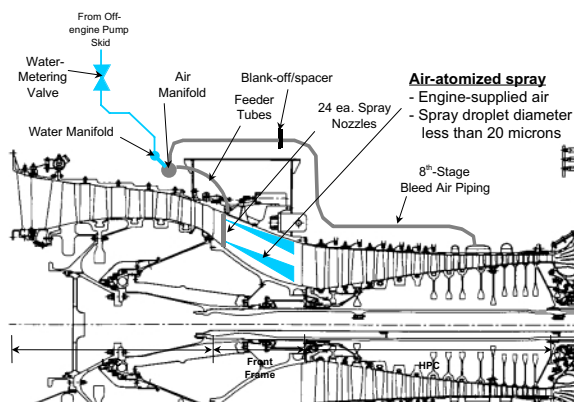

Figure 10. Diagram of LM6000PC SPRINT™ system

Figure 11 shows a typical cooling cycle based on an ambient dry-bulb temperature of 100°F (37.8°C) and 20% relative humidity. Initial cooling follows a line of constant humidity ratio. As the air approaches saturation, moisture begins to condense out of the air. If the air is cooled further, more moisture condenses. Once the temperature reaches this regime, more and more of the heat removed from the air is used to condense the water. This leaves less capacity for temperature reduction. Because of the potential for water condensation, drift eliminators should be installed downstream of the coils to prevent excessive water ingestion by the gas turbine. The exact point at which further cooling is no longer feasible depends upon the desired gas turbine output and the chilling system's capacity.

It is readily apparent from the graph in Figure 11 that the air can be cooled below the ambient wet-bulb temperature. Therein lies one of the major benefits of the cooling coil system. It must be pointed out, though, that the lower limit of cooler operation is a compressor inlet temperature of 45°F (7.2°C) with a relative humidity of 95%. At temperatures below 45°F (7.2°C) with such high relative humidity, icing of the compressor and the resulting risk of equipment damage is probable.

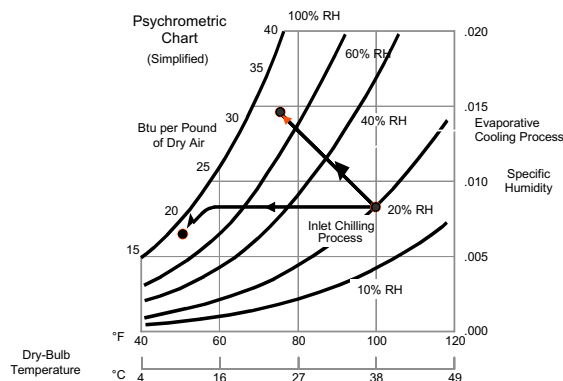

Figure 11. Inlet cooling process

Inlet Chilling Methods

Direct Cooling

Direct cooling provides almost instantaneous cooling for capacity enhancement around the clock. Some of the increase in power output is used to drive the system. Direct cooling systems operate on the same principles, which have cooled industrial processes as well as HVAC systems in large buildings for many years. Large mechanical chillers powered by electricity may be used with heat exchangers (chiller coils) in the gas turbine inlet. These heat exchangers add approximately one inch of water to the inlet pressure drop. Absorption chillers using heat as the energy source are an option if waste heat is available. These typically cost more than mechanical chillers of like capacity but carry lower parasitic loads while operating. The gas turbine inlet air temperature can be reduced as low as 45 to 50°F (7.2 to 10°C), depending on the ambient air dew point, waste heat available and chiller size. Mechanical chillers consume a significant amount of power, so the net gains are less than the absorption system.

The chiller refrigerant requires cooling. Water-cooled chillers require a cooling tower. Mechanical chillers can also be air cooled; however, absorption chillers are available only as water-cooled models.

There are several ways to accomplish direct cooling. These can be divided into two basic types: direct-expansion and chilled-water systems. Direct-expansion systems utilize a refrigerant directly in the cooling coil mounted in the inlet air duct. Chilled-water systems utilize a secondary heating fluid between the refrigerant and the turbine inlet air. This fluid is typically water or a water-glycol mixture.

For example, cooling the inlet air on a GE 7FA unit from 95°F (35°C) dry-bulb, 77°F (25°C)

wet-bulb to 45°F (7.2°C) requires approximately 7.4 T/hr of cooling, providing net increase of 24.1-megawatt gas turbine electrical output at a price of about \$240 per kilowatt. However, it must be considered that this system provides the full performance benefit only on hotter days and the benefit is reduced as ambient temperature decreases. Also, the system reduces power output capacity on cold days below 45°F (7.2°C) due to the increase in gas turbine inlet pressure drop.

Off-Peak Thermal Energy Storage

Where premium prices are paid for power during daytime peak power consumption periods, off-peak thermal energy storage may be the answer. Ice or cold water is produced using mechanical chillers during off-peak hours and weekends and stored in large storage tanks. Capacity enhancement is possible only for a few hours each day. During periods of peak power demand, the cold water or cold water produced from melted ice is used to chill the gas turbine inlet air. This system is capable of reducing gas turbine inlet air temperature to temperatures of between 50 and 60°F. However, significant space is required for the ice or cold water storage.

Comparison of Direct Chilling and Thermal Energy Storage

Direct Chilling

Advantages

- Provides chilled air 24 hours a day
- Simple and reliable
- No off-peak parasitic power required
- Very efficient

Disadvantages

- Requires higher on-peak parasitic power
- Increased capital cost because refrigeration equipment is sized for peak load

Thermal Energy Storage

Advantages

- Low on-peak parasitic power required
- Lower capital cost than direct chilling for peaks lasting less than eight hours

Disadvantages

- Requires more off-peak power
- Higher capital cost than direct chilling for peaks lasting more than 8 hours
- More complex system than direct chilling
- Chilled air available for only part of the day.

LNG/LPG Gas Vaporizers

Where LNG or liquefied petroleum gases (LPG) are used, these fuels need to be vaporized before use in the gas turbine. They are typically delivered to the gas turbine fuel system at temperatures around 50°F (10°C). Gas turbine inlet air can be used to accomplish much of the fuel vaporization and heating. An intermediate fluid such as glycol is used. The gas turbine inlet air heats the glycol and is cooled in this process. The glycol heats the fuel. A 10°F (5.6°C) reduction in inlet air temperature is typical for this system. Because the fuel needs to be vaporized anyway, chilling the inlet air provides a way of turning a large portion of the energy into useable power.

Power Augmentation

Three basic methods are available for power augmentation: water or steam injection, HRSG supplementary firing and peak firing.

Gas Turbine Steam/Water Injection

Injecting steam or water into the head end of the combustor for NO_x abatement increases mass flow and, therefore, output. Generally, the amount of water is limited to the amount

required to meet the NO_x requirement in order to minimize operating cost and impact on inspection intervals. Steam injection for power augmentation has been an available option for over 30 years. When steam is injected for power augmentation, it can be introduced into the compressor discharge casing of the gas turbine as well as the combustor. In combined-cycle operation, the cycle heat rate increases with steam or water injection. In the case of water injection, this is primarily due to the use of high-grade fuel energy to vaporize and heat the water. In the case of steam injection, this is primarily due to the use of bottoming cycle energy to generate the steam for the gas turbine that could otherwise be used in the steam turbine. A secondary factor is that typical control systems reduce firing temperature when injecting steam or water. This counteracts the effect of higher heat transfer due to the extra water vapor on the gas side to maintain hot gas path part life.

GE gas turbines are designed to allow typically up to 5% of the compressor airflow for steam injection to the combustor and compressor discharge. The amount of steam injection is a function of gas turbine and gas turbine combustion system. Steam must contain at least 50°F (28°C) superheat and be at pressures comparable to fuel gas pressures. When either steam or water is used for power augmentation, the control system is normally designed to allow only the amount needed for NO_x abatement until the machine reaches base (full) load. At that point, additional steam or water can be admitted through the governor control.

Supplementary Fired HRSG

Because gas turbines generally consume a small fraction of the available oxygen within the gas turbine air flow, the oxygen content of the gas turbine exhaust generally permits supplementary fuel firing ahead of (or within) the HRSG

to increase steam production rates relative to an unfired unit. A supplementary fired unit is defined as an HRSG fired to an average temperature not exceeding about 1800°F (982°C).

Because the turbine exhaust gas is essentially preheated combustion air, the supplementary fired HRSG fuel consumption is less than that required for a power boiler, providing the same incremental increase in steam generation. Incremental plant heat rate for supplementary firing is typically in the range of a simple-cycle gas turbine.

An unfired HRSG with higher steam conditions is often designed with multiple pressure levels to recover as much energy as possible from the gas turbine exhaust. This adds cost to the unfired HRSG, but the economics are often enhanced for the cycle. In the case of the supplementary fired HRSG, if the HRSG is to be fired during most of its operating hours to the 1400-to-1800°F (760–982°C) range, then a suitably low stack temperature can usually be achieved with a single-pressure-level unit. This is the result of increased economizer duty as compared to the unfired HRSG.

A supplementary fired HRSG has a design quite similar to that of an unfired HRSG. However, the firing capability provides the ability to control the HRSG steam production within the capability of the burner system and independent of the normal gas turbine operating mode. Supplementary fired HRSGs are applicable to new units or combined-cycle add-ons. Retrofit installations on existing HRSGs are not practical due to the need for duct burner space and significant material changes.

There is a small performance penalty when operating unfired compared to operating a unit designed without supplementary firing, and the magnitude of this performance penalty is directly proportional to the amount of supple-

mentary firing built into the combined-cycle plant. The performance penalty is due to two factors: unfired operation results in lower steam flows and pressures and, thus, lower steam turbine efficiency; also, the pumps, auxiliary equipment and generator are sized for higher loads. Operating unfired results in comparatively higher parasitic loads compared to a unit designed solely for unfired operation.

Peak Firing

Users of some gas turbine models have the ability to increase their firing temperature above the base rating. This is known as peak firing, where both simple-cycle and combined-cycle output will increase. The penalty for this type of operation is shorter inspection cycles and increased maintenance. Despite this, running at elevated peak firing temperatures for short periods may be a cost-effective way to add kilowatts without the need for additional peripheral equipment.

Output Enhancement Summary

Several output enhancement techniques and systems have been discussed. A comparison of the potential performance impacts for each technique based on a 90°F (32.2°C), 30% RH day are shown in *Table 1*.

Before any of these enhancements are applied to an existing plant, the steam turbine, balance

of plant and generator capability need to be reviewed to ensure operating limits will not be exceeded. For example, generator output may be limited on hot days due to reduced cooling capability.

Efficiency Enhancement

Fuel Heating

If low-grade heat energy is available, this can be used to increase the temperature of gaseous fuels, which increases cycle efficiency by reducing the amount of fuel energy used to raise the fuel temperature to the combustion temperature. There is a very small (almost negligible) reduction in gas turbine output compared to the no-fuel heating case, primarily due to the lower gas turbine mass flow as a result of the reduction in fuel consumption. The reduction in combined-cycle output is typically greater than simple-cycle output primarily because energy that would otherwise be used to make steam is often used to heat the fuel. Actual combined-cycle output and efficiency changes are dependent on fuel temperature rise and cycle design. Provided the fuel constituents are acceptable, fuel temperatures can potentially be increased up to approximately 700°F (370°C) before carbon deposits begin to form on heat transfer surfaces and the remainder of the fuel delivery system. For combined-cycle applications, fuel temperatures on the order of 300 to 450°F (150–230°C) are generally economically optimal.

A combined-cycle plant has plenty of low-grade heat energy available. Typical F-class three-pressure reheat systems use water from the intermediate pressure economizer to heat the fuel to approximately 365°F (185°C). Under these conditions, efficiency gains of approximately 0.3 points can be expected for units with no stack temperature limitations.

Power Enhancement Option	Power Performance Impact	
	Δ Output	Δ Heat Rate
Base Configuration	Base	Base
Evaporative Cooling GT Inlet Air (85% Effective Cooler)	+5.2%	-
Chill GT Inlet Air to 45°F	+10.7%	+1.6%
GT Peak Load	+5.2%	+1/0%
GT Steam Injection (5% of GT Air Flow)	+3.4%	+4.2%
GT Water Injection	+5.9%	+4.8%
HRSG Supplementary Firing	+28%	+9.0%

Table 1. STAG system power-enhancement options

It is important to ensure that the fuel does not enter the steam system because maximum steam system temperatures are typically above the auto ignition temperature for gas fuels. This can be accomplished in several ways. For a system utilizing a direct water-to-fuel heat exchanger, the water pressure is maintained above the fuel pressure so that any leakage takes place in the fuel system. Additional system design and operation requirements ensure that the fuel does not enter the steam system during periods when the water system is not pressurized. *Figures 12 and 13* show the details of such a

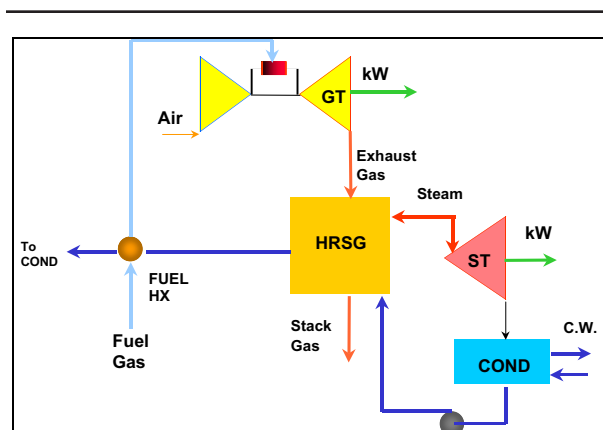

Figure 12. Fuel heating functional block diagram

system. Other systems use an intermediate heat transfer fluid so that any fuel heat exchanger leakage cannot directly enter the steam system. For uprate opportunities, it must be considered that additional water flow may be required. Calculations must be performed to ensure the existing pump capabilities are not exceeded and that pressures are sufficient to deliver water to the HRSG drums under worst-case conditions. Other components that may see increased water flows (such as HRSG economizers) must be evaluated to ensure the design is acceptable.

Performance-Enhancement Case Study

The economic analysis of performance-enhancement alternatives is highly dependent upon plant configuration, capacity factor, expected electricity price duration curves and fuel cost. As such, each plant needs to be evaluated on a case-by-case basis. As an example, an economic evaluation for a typical GE STAG 207FA three-pressure reheat plant is presented. The economic evaluation presented here assumes that power-enhancement options are used only during annual summer peak power demand periods and that for the remainder of the year the plant is operated at baseload (at annual average ambient conditions). In other words, there are two levels of plant performance considered when evaluating the net economic benefit of any given plant power-enhancement arrangement. These are baseload plant performance at (baseload) annual average ambient conditions and peak-load performance at (peak-load) maximum ambient conditions.

Utilization of power-enhancement alternatives at ambient conditions other than peak-load ambient conditions may add to the economic evaluation benefit of that alternative. For exam-

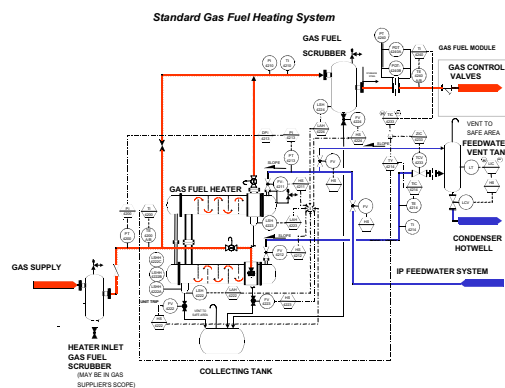

Figure 13. Standard gas fuel heating system

ple, it is common practice to design gas turbine inlet chilling systems so that it is possible to maintain a constant gas turbine compressor inlet air temperature across the ambient temperature range (to a minimum temperature of approximately 45°F). By operating a chiller in this fashion, combined-cycle output would be improved even at annual average ambient or baseload ambient conditions. Provided the demand for electricity exists, this may afford an additional economic evaluation benefit (this consideration has not been evaluated in the case study presented).

Assumptions/Base Plant Description

Assumptions

Fixed

Annual average ambient conditions:

59°F, 60% RH, 14.7

Peak period ambient conditions:

95°F, 45% RH, 14.7 psia

Fuel—natural gas (LHV): 21,515 Btu/lbm

Evaluation term: 20 years

Escalation rate: 3% per year

Discount rate: 10%

Fixed-charged rate: 16%

Annual capacity factor: 85% (7446 hrs/year)

Variable

Fuel cost: \$1.50–\$3.50 /MMBtu

Peak energy rate: 4.5–18 ¢/kWh

Peak energy period: 100–3000 hrs/year

Base Plant Configuration

The baseline plant configuration, to which all peak power-enhancement alternatives are compared, is a GE STAG 207FA combined-cycle plant. This plant consists of two PG7241 (FA) gas turbines with a nine-ppmvd (15% O₂) gas-only DLN combustion system; two unfired, three pressure-level HRSGs with 15°F to 10°F

pinch and subcooling for all pressure levels; and a GE-type D11 reheat steam turbine with rated throttle conditions of 1800 psia/1050°F/1050°F and a rated exhaust pressure of 1.5 in Hga. The cooling system is a combination of a wet cooling tower and condenser. The baseline plant configuration does not include any power enhancement equipment.

Estimated Baseline Plant Performance:

@ annual average ambient (59°F)

Net plant output (kW): 514,550

Net plant heat rate (Btu/kWh): 6197

@ peak period ambient (95°F)

Net plant output (kW): 456,320

Net plant heat rate (Btu/kWh): 6323

For the purpose of this study, the capital cost associated with the baseline plant configuration on a turnkey basis was estimated to be \$420 per kilowatt (referenced to the annual average performance level). The annual operation and maintenance (O&M) cost associated with the base configuration was estimated to be \$14.45 million on a first-year annual basis.

Description of Methods

Starting with the baseline plant configuration defined above, a variety of power-enhancement alternatives and combinations of alternatives were added to the base configuration. *Exhibit 1* contains a complete listing of the power-enhancement alternatives considered in this study. It is necessary to note that the HRSG, condenser and cooling tower designs were optimized for the base-line plant configuration and that this same hardware was used in conjunction with each of the power-enhancement alternatives to calculate the (off-design) performance associated with each of the alternatives. Further, it has been assumed that there are no

Exhibit 1. List of Performance Enhancements

Case No.	Description: Peak Power Enhancement Method
Case 1	GT Peak Firing (35°F)
Case 2	GT Steam Injection (3.5% of Compressor Inlet Air flow, CIA)
Case 3	GT Steam Injection (5.0% of Compressor Inlet Air flow, CIA)
Case 4	GT Peak Firing (35°F) + Steam Injection to 3.5% CIA
Case 5	GT Peak Firing (35°F) + Steam Injection to 5.0% CIA
Case 6	GT Evaporative Cooling (Ambient Relative Humidity-45%)
Case 7	GT Evaporative Cooling (Ambient Relative Humidity-60%)-Sensitivity
Case 8	GT Inlet Fogging (Ambient Relative Humidity-45%)
Case 9	GT Inlet Fogging (Ambient Relative Humidity-60%)Sensitivity
Case 10	GT Inlet Chilling to 45°F (Ambient RH-45%), Chiller with External Heat Sink.
Case 11	GT Inlet Chilling to 45°F (Ambient RH-45%), Chiller with Cooling Tower Sink
Case 12	GT Inlet Chilling to 45°F (Ambient RH-60%), Chiller with External Heat Sink.
Case 13	GT Inlet Chilling to 45°F (Ambient RH-60%), Chiller with Cooling Tower Sink
Case 14	HRSG Duct Firing-Steam turbine sliding pressure mode of operation. Fired to approximately 45% increase in HP steam production.
Case 15	HRSG Duct Firing-Steam turbine fixed-pressure mode of operation with HP throttle bypass to cold reheat. Fired to output achieved in Case 14.
Case 16	HRSG Incremental Duct Firing-Firing from nominal throttle pressure to max HP inlet throttle pressure limit.
Case 17	GT Steam Injection (5.0% CIA) + Incremental HRSG Duct Firing
Case 18	GT Steam Injection (3.5% CIA) + Incremental HRSG Duct Firing
Case 19	GT Peak Firing + Steam Injection (5.0% CIA) + Incremental HRSG Duct Firing
Case 20	GT Steam Injection (3.5% CIA) + Evaporative Cooling (Amb. RH-45%)
Case 21	GT Steam Injection (3.5% CIA) + Evaporative Cooling (Amb. RH-45%) + Incremental HRSG Duct Firing.
Case 22	GT Inlet Chilling + GT Steam Injection (3.5% CIA)
Case 23	GT Inlet Chilling + GT Steam Injection (3.5% CIA) + Incremental HRSG Firing
Case 24	GT Inlet Chilling + GT Steam Injection (5.0% CIA)
Case 25	GT Inlet Fogging + GT Steam Injection (3.5% CIA)
Case 26	GT Water Injection
Case 27	GT Water Injection + Incremental HRSG Duct Firing
Case 28	GT Inlet Fogging-to saturation
Case 29	GT Steam Injection (3.5% CIA) with steam supply taken from the HP superheat discharge. (Note: All other steam injection cases assume steam taken from IP superheater with the balance made up from the HP superheater.)
Case 30	Addition of a PG7121(EA) Peaking Gas Turbine Generator Set

Notes

1. Steam injection beyond 3.5% of the gas turbine compressor air flow is not an available option for the current PG7241FA gas turbine with a DLN combustor. 5.0% steam-injection cases are used for theoretical purposes only.
2. Water injection is not an available alternative to application with a PG7241FA. The case is presented to examine theoretical results.
3. GT inlet fogging to saturation is presented for theoretical evaluation purposes only.

Exhibit 1. List of performance enhancements

limitations with respect to the availability of water and that the only penalty associated with additional water consumption beyond that required for the base case is the incremental capital cost associated with the water treatment systems.

For each of the enhancement alternatives considered, plant performance (output and heat rate) was developed at both the annual average ambient conditions without the performance enhancement operating and at the peak power period ambient conditions with the enhancement in operation. Incremental plant capital cost and incremental O&M costs were established and fed into a COE model along with the performance at the annual average ambient conditions and the peak period ambient conditions.

The COE model (including all performance enhancement alternatives) was run across a

range of fuel costs, peak power energy rates and peak versus non-peak annual operating hours. The results from this parametric COE analysis are summarized in *Exhibits 1a and 1b*. *Exhibit 1a* summarizes the key economic evaluation parameters associated with individual performance-enhancement technology (excluding combinations of technologies), while *Exhibit 1b* provides a 20-year NPV economic ranking of all the enhancement alternatives and combination of alternatives as a function of peak energy rate, peak period duration and fuel cost.

All enhancement alternatives were evaluated relative to the base case. Positive numbers for value vs. base in this table represent a net (life cycle, NPV evaluation) benefit, while negative values represent a deficit relative to the base.

The optimal power-enhancement alternative should be a low-risk alternative with highest peak power revenue-generating capacity (low

Economic and Technical Considerations for Combined-Cycle Performance-Enhancement Options

Annual Peak Operating Hours:	500						
Peak Energy Rate (¢/kWh):	9.00						
Fuel Cost (\$/MMBTU) - HHV:	\$2.50						
Reference Case	Base	Case 1 GT Peak Load	Case 2 Steam Injection (3.5% CIA)	Case 6 Evap. Cooling (45% RH)	Case 8 Inlet Fogging (45% RH)	Case 10 GT Inlet Chilling (45% RH)	Case 14 Duct Firing (Sliding Press.)
Average Base Load Performance (Ambient Conditions: 99°F, 60% RH)							
Net Plant Output (kW)	521,939	521,939	521,939	520,371	521,405	520,371	519,022
Net Plant Heat Rate (Btu/kW-hr)	6,110	6,110	6,110	6,109	6,109	6,109	6,144
Average Peak Load Performance (Ambient Conditions: 99°F, 45% RH)							
Net Plant Output (kW)	463,420	475,425	475,824	484,811	488,387	510,506	534,707
Net Plant Heat Rate (Btu/kW-hr)	6,226	6,208	6,411	6,221	6,215	6,394	6,577
Capital Investment of Enhancement + Associated B.O.P. (\$MM)	-NA-	0.4	4.1	1.4	1.1	11.5	3.7
First-Year COE (¢/kWh)	2.98	2.97	3.00	2.97	2.98	3.01	2.99
20-Year Levelized COE (¢/kWh)	3.63	3.64	3.68	3.64	3.63	3.69	3.66
Potential Risk: NPV Evaluation Relative to Base @ Uniform Price of Electricity (\$MM)	Base	(1.72)	(9.83)	(1.32)	(0.30)	(11.24)	(6.19)
Potential Net Benefit (Reward - Risk) Total Levelized Net Benefit From Peaking Capacity Relative to Base (\$MM)	Base	\$1.07	(\$6.95)	\$3.63	\$5.48	(\$0.33)	\$10.33

Annual Peak Operating Hours: 1000
Peak Energy Rate (¢/kWh): 9.00
Fuel Cost (\$/MMBTU) - HHV: \$2.50

Reference Case	Base	Case 1 GT Peak Load	Case 2 Steam Injection (3.5% CIA)	Case 6 Evap. Cooling (45% RH)	Case 8 Inlet Fogging (45% RH)	Case 10 GT Inlet Chilling (45% RH)	Case 14 Duct Firing (Sliding Press.)
Average Base Load Performance (Ambient Conditions: 99°F, 60% RH)							
Net Plant Output (kW)	521,939	521,939	521,939	520,371	521,405	520,371	519,022
Net Plant Heat Rate (Btu/kW-hr)	6,110	6,110	6,110	6,109	6,109	6,109	6,144
Average Peak Load Performance (Ambient Conditions: 99°F, 45% RH)							
Net Plant Output (kW)	463,420	475,425	475,824	484,811	488,387	510,506	534,707
Net Plant Heat Rate (Btu/kW-hr)	6,226	6,208	6,411	6,221	6,215	6,394	6,577
Capital Investment of Enhancement + Associated B.O.P. (\$MM)	-NA-	0.4	4.1	1.4	1.1	11.5	3.7
First-Year COE (¢/kWh)	2.97	2.98	3.01	2.97	2.97	3.01	2.99
20-Year Levelized COE (¢/kWh)	3.65	3.65	3.70	3.65	3.64	3.70	3.67
Potential Risk: NPV Evaluation Relative to Base @ Uniform Price of Electricity (\$MM)	Base	(1.16)	(10.14)	(0.41)	0.74	(10.08)	(4.68)
Potential Net Benefit (Reward - Risk) Total Levelized Net Benefit From Peaking Capacity Relative to Base (\$MM)	Base	\$4.39	(\$4.41)	\$9.49	\$12.29	\$11.70	\$28.29

Annual Peak Operating Hours:	500						
Peak Energy Rate (¢/kWh):	12.00						
Fuel Cost (\$/MMBTU) - HHV:	\$2.50						
Reference Case	Base	Case 1 GT Peak Load	Case 2 Steam Injection (3.5% CIA)	Case 6 Evap. Cooling (45% RH)	Case 8 Inlet Fogging (45% RH)	Case 10 GT Inlet Chilling (45% RH)	Case 14 Duct Firing (Sliding Press.)
Average Base Load Performance (Ambient Conditions: 99°F, 60% RH)							
Net Plant Output (kW)	521,939	521,939	521,939	520,371	521,405	520,371	519,022
Net Plant Heat Rate (Btu/kW-hr)	6,110	6,110	6,110	6,109	6,109	6,109	6,144
Average Peak Load Performance (Ambient Conditions: 99°F, 45% RH)							
Net Plant Output (kW)	463,420	475,425	475,824	484,811	488,387	510,506	534,707
Net Plant Heat Rate (Btu/kW-hr)	6,226	6,208	6,411	6,221	6,215	6,394	6,577
Capital Investment of Enhancement + Associated B.O.P. (\$MM)	-NA-	0.4	4.1	1.4	1.1	11.5	3.7
First-Year COE (¢/kWh)	2.98	2.97	3.00	2.97	2.98	3.01	2.99
20-Year Levelized COE (¢/kWh)	3.63	3.64	3.68	3.64	3.63	3.69	3.66
Potential Risk: NPV Evaluation Relative to Base @ Uniform Price of Electricity (\$MM)	Base	(1.72)	(9.83)	(1.32)	(0.30)	(11.24)	(6.19)
Potential Net Benefit (Reward - Risk) Total Levelized Net Benefit From Peaking Capacity Relative to Base (\$MM)	Base	\$2.45	(\$5.53)	\$6.10	\$8.35	\$5.08	\$18.54

Annual Peak Operating Hours: 1000
Peak Energy Rate (¢/kWh): 12.00
Fuel Cost (\$/MMBTU) - HHV: \$2.50

Reference Case	Base	Case 1 GT Peak Load	Case 2 Steam Injection (3.5% CIA)	Case 6 Evap. Cooling (45% RH)	Case 8 Inlet Fogging (45% RH)	Case 10 GT Inlet Chilling (45% RH)	Case 14 Duct Firing (Sliding Press.)
Average Base Load Performance (Ambient Conditions: 99°F, 60% RH)							
Net Plant Output (kW)	521,939	521,939	521,939	520,371	521,405	520,371	519,022
Net Plant Heat Rate (Btu/kW-hr)	6,110	6,110	6,110	6,109	6,109	6,109	6,144
Average Peak Load Performance (Ambient Conditions: 99°F, 45% RH)							
Net Plant Output (kW)	463,420	475,425	475,824	484,811	488,387	510,506	534,707
Net Plant Heat Rate (Btu/kW-hr)	6,226	6,208	6,411	6,221	6,215	6,394	6,577
Capital Investment of Enhancement + Associated B.O.P. (\$MM)	-NA-	0.4	4.1	1.4	1.1	11.5	3.7
First-Year COE (¢/kWh)	2.97	2.98	3.01	2.97	2.97	3.01	2.99
20-Year Levelized COE (¢/kWh)	3.65	3.65	3.70	3.65	3.64	3.70	3.67
Potential Risk: NPV Evaluation Relative to Base @ Uniform Price of Electricity (\$MM)	Base	(1.16)	(10.14)	(0.41)	0.74	(10.08)	(4.68)
Potential Net Benefit (Reward - Risk) Total Levelized Net Benefit From Peaking Capacity Relative to Base (\$MM)	Base	\$7.15	(\$1.55)	\$14.41	\$18.03	\$22.54	\$44.69

Exhibit 1a. COE summary across multiple economic scenarios

risk being defined as an alternative that has a relatively low initial capital cost and a minimum detrimental impact on performance at the annual average ambient operating point).

From the perspective of economic risk it is also necessary to consider that the power generation market is not stagnant. In other words, aside from viewing the economic evaluation benefit from the perspective of today's market, one should give a fair amount of consideration to future market expectations. In the future one could expect that as the installed capacity base of power generation equipment in the domestic market increases, there will be a potential for erosion of peak energy rates and peak power capacity demand, coupled with escalating fuel prices. As peak energy rates approach the base price of electricity, it is expected that efficiency rather than capacity will once again be the primary economic driver in the selection of per-

formance-enhancement equipment options. In such a market environment, one might expect that plants with the highest efficiencies would be more profitable and would be dispatched before high-capacity, lower-efficiency plants.

To further illustrate this point, *Figures 14 and 15* show potential market trends associated with consumer electricity rates and fuel prices. (Both figures were extracted from the DOE Energy Information Administration Web site.)

Figure 14 represents a combined forecast of electricity rates and fuel prices as a function of time. The y-axis of the graph represents the ratio of projected fuel prices and electricity rates to those that existed in 1990. It is also noteworthy that the declining trend in the electricity rate is a direct result of competition among electricity suppliers as a result of deregulation within the power generation industry.

Figure 15 represents a projection of fuel price trends for a wide variety of fuels. The values depicted as the y-axis on the graph represents fuel price in \$/1000 ft³.

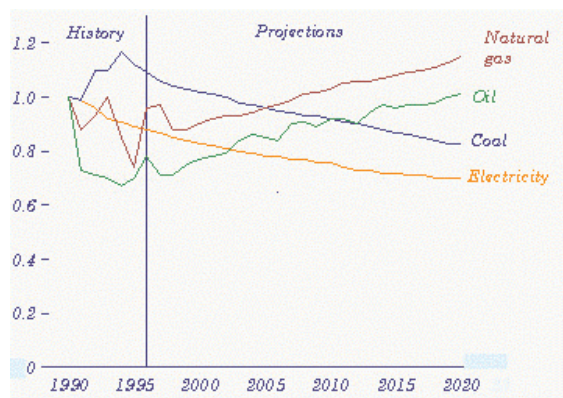

Figure 14. Projected fuel/electricity prices

Discussion

Given the number of alternatives investigated, it is impractical to describe and discuss the results of the parametric COE study for each alternative in any significant detail. As such, this discussion is limited to general categories of peak power alternatives that were evaluated best under almost all the economic scenarios examined. These alternatives have been divided into

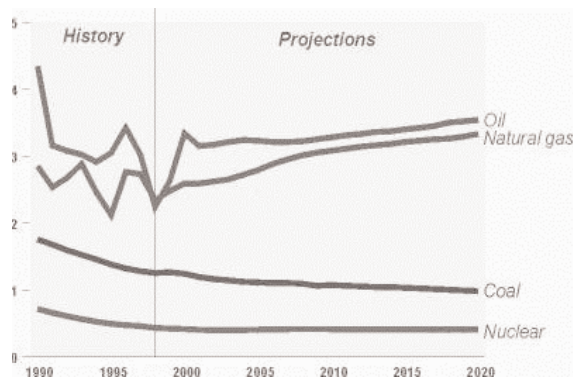

Figure 15. Projection of fuel prices

general categories of HRSG duct firing, gas turbine inlet air fogging, gas turbine inlet air chilling and gas turbine evaporative cooling.

HRSG Duct Firing

Two methods of HRSG duct firing were examined for the purpose of this study. The first is GE's traditional method, which is based upon sliding-pressure operation of the steam turbine. This configuration is designed such that the throttle pressure in an unfired mode of operation at the annual average ambient conditions is significantly less than the throttle pressure of the base case at the same ambient conditions. The throttle pressure in the unfired mode of operation was intentionally lowered by increasing the HP bowl inlet area such that the steam turbine could accommodate the additional steam flow produced when the HRSG is fired without exceeding a maximum throttle pressure limit of approximately 1900 psia. The level of firing considered in this study is such that the fired HP steam production is roughly equivalent to 1.45 times the HP steam production of the base plant at the annual average ambient conditions. While this method of HRSG duct firing allows for a significant gain (approximately 15% net plant output or approximately 41% in gross steam turbine-generator output) in peak period power production over the base configuration, there is a small reduction in power and an associated increase in heat rate relative to the base case in an unfired mode of operation. This reduction was found to be roughly 3 megawatts in net plant output.

The second method of duct firing is a fixed-pressure mode of operation. The rated throttle pressure for this case is equal to that of the base case at the annual average ambient conditions. In this case the maximum throttle pressure is limited to approximately 1900 psia through the

bypassing of HP steam into the cold reheat. Thus, a maximum steam turbine generator output equivalent to the sliding pressure case can be achieved without sacrificing any significant unfired performance relative to the base configuration. The disadvantages to this configuration is that it has a slightly higher capital cost than that associated with the sliding pressure configuration, and there is a higher duct burner fuel consumption when firing to a steam turbine generator output equal to that obtained with the sliding pressure configuration. The steam turbine generator output obtained represents a gain in gross steam turbine generator output of approximately 41%, correlating to a gain in net plant output of approximately 14.5% relative to the base plant configuration performance at peak period ambient conditions.

Gas Turbine Inlet Fogging/Evaporative Cooling

Since the performance benefits gained through the application of either evaporative cooling or an inlet fogging system are sensitive to variation in ambient relative humidity (*see Figure 5*), it is logical to assume that the economic evaluation benefit of both systems is also sensitive to variations in ambient relative humidity. This case study attempts to address this phenomenon by examining the evaluation benefit of each system at both nominal “peak-load” ambient conditions 95°F, 45% RH, as well as at 95°F and 60% RH (*cases 6, 7, 8 and 9*).

The benefit of fogging over traditional evaporative coolers appears to be threefold: lower capital cost, more effective cooling (ability to achieve lower gas turbine compressor inlet temperatures) and a much lower gas turbine inlet pressure drop through the application of the fogging hardware. Given that the inlet air-cool-

ing potential is higher with the fogging system than the evaporative cooling system, the result is a higher peak period power improvement. In addition, during nonpeak periods (when the power-enhancement devices are not in service), the plant configured with an inlet fogging system has a higher plant output than a plant configured with a traditional evaporative cooling system. This is a direct result of the lower inlet pressure drop associated with inlet fogging as opposed to that associated with a traditional evaporative cooling system.

One potential drawback to the fogging system is the potential for water droplet carryover into the gas turbine compressor inlet. The potential problems associated with water carryover into the compressor and impact of water carryover on DLN combustion system operation are currently under investigation.

Gas Turbine Inlet Chilling

For the purpose of this study, a mechanical chilling system with chilling to a gas turbine compressor inlet temperature of 45°F was studied as a potential means of producing additional peak period power. As in the case of evaporative cooling, chilling systems sizing and effectiveness is impacted by the ambient relative humidity. Thus, this study includes inlet air chilling to 45°F at ambient conditions of 95°F, 45% RH, and 95°F, 60% RH, to determine the sensitivity of the COE for chilling with respect to ambient relative humidity.

The effect of a chilling system utilizing the main cooling tower as a heat sink compared with a system with a dedicated cooling system was also taken into consideration. The chilling system with a dedicated cooling system results in a slightly higher performance level than the system using the main cooling tower because it does not have an impact on the steam turbine

back pressure; however, its performance benefit is more than offset by the additional capital cost of the dedicated cooling system.

This study does not address alternative inlet chilling arrangements such as thermal storage and absorption chilling cycles, described previously.

Results

Under almost every economic scenario considered in this study, HRSG duct firing (both in sliding- and fixed-pressure modes of operation) appears to be a clear winner in terms of a 20-year COE evaluation relative to the base case (case without any power enhancement equipment). Duct firing is followed by inlet fogging, evaporative cooling and inlet air chilling that, in general, also have favorable evaluations relative to the base. A general exception to this is inlet air chilling at peak power rates less than 9 cents per kilowatt hour (*refer to Exhibit 1*).

Graphical representation of incremental peak power revenue as a function of peak energy rate versus peak operating hours has been provided for each of these alternatives (*Exhibit 2*). This data illustrates each alternative's sensitivity to operating hours, fuel cost and peak energy rate and establishes categories of risk vs. reward associated with the alternatives.

The four alternatives described above have been divided into three categories based upon the potential risk and reward associated with each of the alternatives. These categories are low risk-moderate reward, moderate risk-high reward and high risk-high reward. Graphical representations of risk vs. reward on a net present value (NPV) basis for these four alternatives are attached (*Exhibit 3*). The risk associated with a given alternative is the capital investment for that alternative combined with the value of the lost performance during nonpeak operating hours. The eco-

nomical penalty resulting from lost performance is evaluated assuming a uniform price of electricity. In other words the economic penalty accounts for any incremental increase in the COE of a given alternative relative to the base case and is independent of peak energy rate and peak load duration. For this study, the NPV of this lost performance is referred to as a nonpeak performance burden. The reward has been defined as the NPV of the incremental revenue associated with a given alternative during peak operational periods relative to the base over an evaluation term of 20 years. Referring to *Exhibit 3*, the optimal peak performance plant alternative for any given economic scenario will be the one that is farthest from the y-axis in conjunction with being closest to the x-axis. The solid line on these curves represents parity between the potential risk and reward. In other words, a point on this line represents a scenario in which the potential reward is equivalent to potential risk. It should be noted that for some alternatives, under certain economic scenarios it is possible to achieve a negative value for risk, which represents the benefit that could be achieved by that alternative, assuming uniform price of electricity annually.

The incremental installed capital investment associated with a given power-enhancement alternative is an integral part of the overall economic analysis model. Although it is believed that the best possible estimates were utilized within the COE model used throughout the course of this study, it is worthwhile to consider the model's sensitivity to this parameter. In general, the capital investment associated with each of the alternatives is a very small percentage of the total capital investment. Thus, a small deviation between the estimated investment capital relative to an actual, as-procured/installed capital investment should not compromise the integrity of the conclusions drawn from the results of the study.

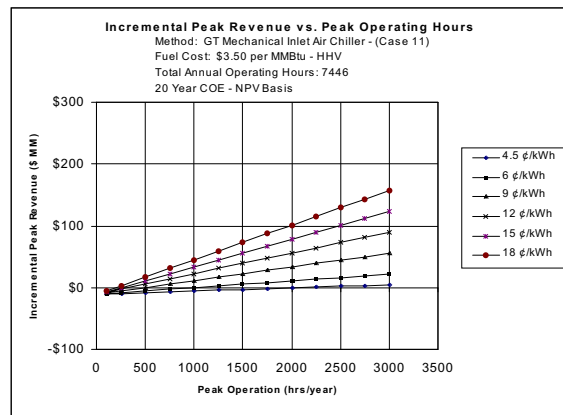
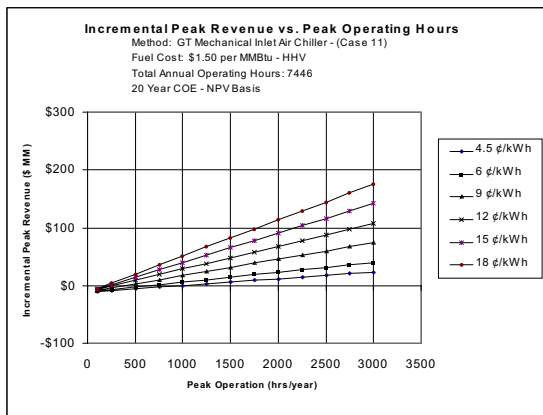
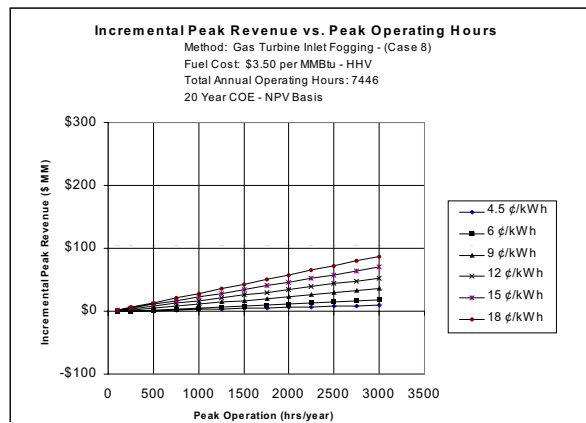
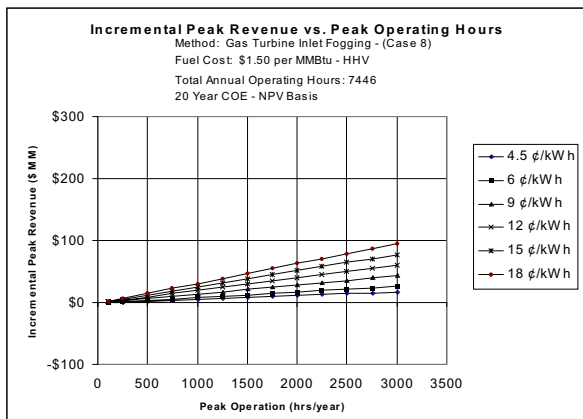
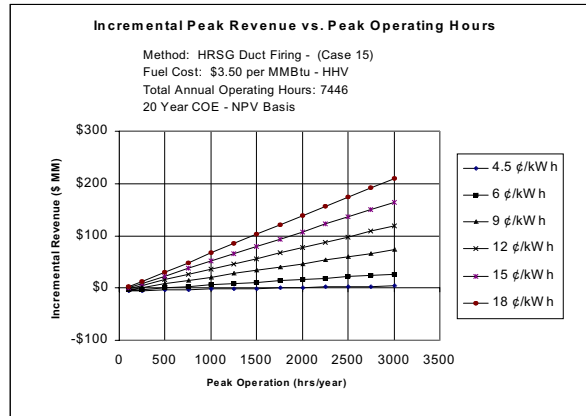
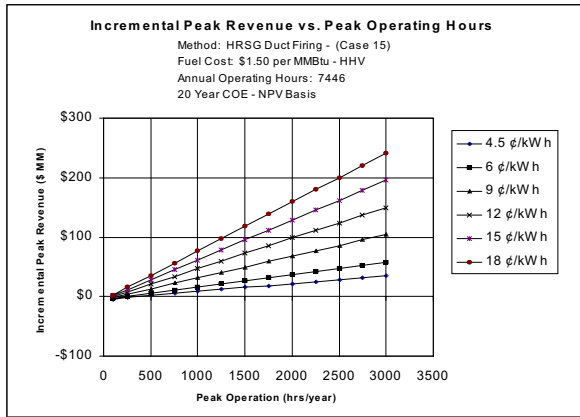

Exhibit 2. Incremental peak power revenue vs. peak operating hours (by peak power alternative)

Although the relative ranking of the various peak power-enhancement alternatives will not be significantly altered, the evaluation of an alternative

relative to the base plant configuration will be slightly influenced. In an effort to address any potential concerns associated with this point, the

Economic and Technical Considerations for Combined-Cycle Performance-Enhancement Options

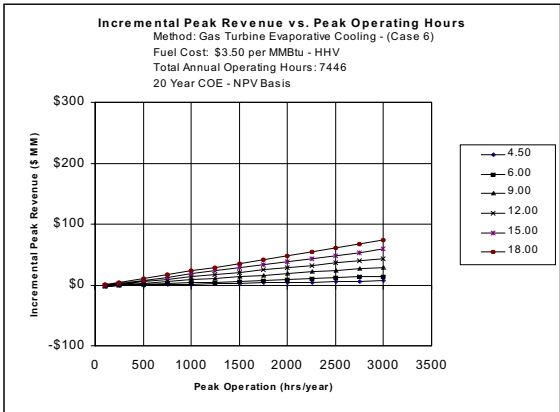
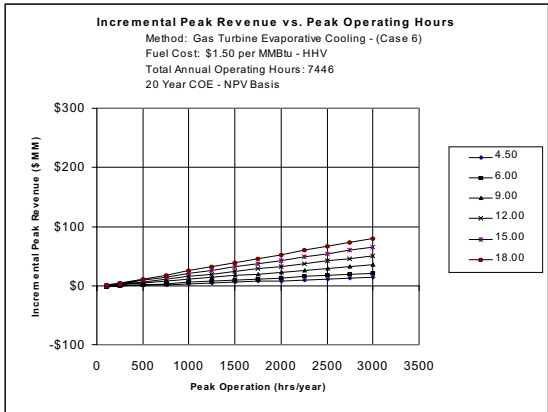

Exhibit 2 (cont). Incremental peak power revenue vs. peak operating hours (by peak power alternative)

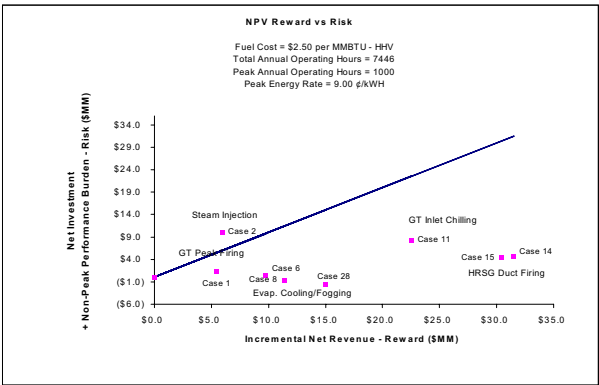
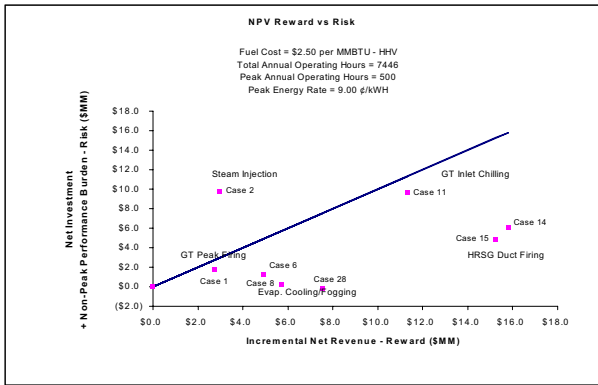
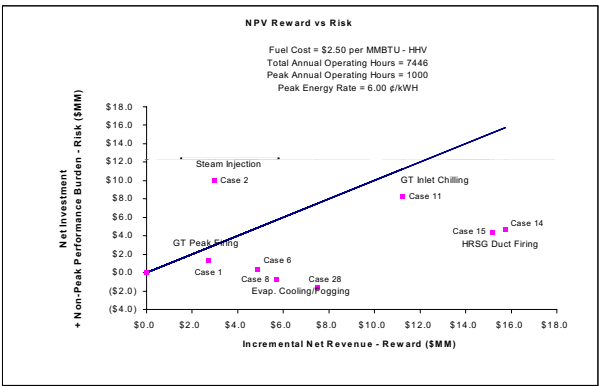
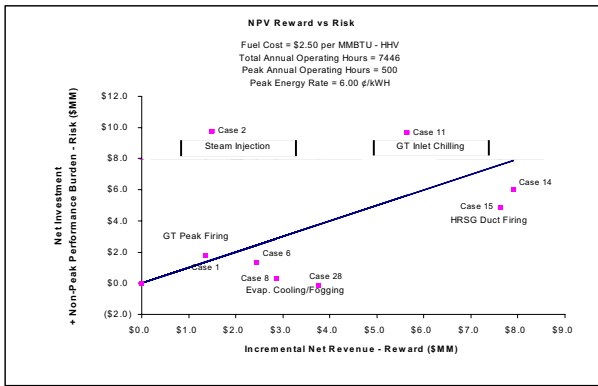

Exhibit 3. Risk vs. reward trade-off plots (NPV basis)

COE model was run assuming a $\pm 10\%$ change in each alternative's capital investment requirement to make an assessment of the sensitivity of

the relative evaluation to this change (see Table 2). Table 2 can be used in conjunction with Exhibits 1a and 1b to assess the relative ranking of these

alternatives as well as the change in evaluation relative to the base plant configuration.

HRSG Duct Firing

Of all the peak power enhancement options examined, HRSG duct firing represents one of

Power-Enhancement Technology	Change in Capital Investment	Relative Change in Evaluation (\$MM) NPV
GT Peak Firing	±10%	-0.04/+0.04
Evaporative Cooling	±10%	-0.13/+0.13
Inlet Fogging	±10%	-0.11/+0.11
Inlet Chilling	±10%	-1.01/+1.01
Steam Injection	±10%	-0.41/+0.41
HRSG Duct Firing	±10%	-0.37/+0.37

Table 2. Effect of capital investment change on economic evaluation

the largest gains in incremental peak power production (approximately 15% in net plant output relative to the base case) and evaluates favorably relative to the base case under all economic scenarios considered in this study. As such, the application of HRSG duct firing appears to have a moderate risk, with the potential for a high reward (relative to the other three alternatives discussed here) across a 20-year COE evaluation period. The risk has been defined as being moderate due the relatively high up-front capital investment combined with its high sensitivity to operating hours, fuel cost and peak period power rates. In this study it was determined that the capital investment for duct firing was the third largest of all the alternatives. (The application of a PG7121 [EA] required the largest capital investment and was followed by gas turbine inlet air chilling.)

It should be noted that the duct-firing rate considered in this study is a modest one in terms of the incremental increase in both STG and net

plant output. Although it is possible to achieve plant capacities above and beyond those considered here, thus achieving larger peak revenue streams, additional economic risk will be incurred. In general, as more and more peak firing capacity is designed into the plant arrangement, the unfired “baseload” plant performance is shifted further away from the optimal unfired plant performance (base case). Thus, when and if the current power generation market shifts from one that is driven primarily by capacity to one that is driven by efficiency, a plant economically optimized around a capacity-driven market would be economically disadvantaged relative to one optimized around base load efficiency.

Of the two HRSG duct-firing alternatives described above, duct firing in a fixed-pressure mode of operations tends to favor low-peak operation hours, while duct firing in a sliding-pressure mode tends to favor high-peak operation hours. This trend exists because fixed-pressure arrangement is more efficient (with higher steam turbine generator output in an unfired mode of operation) during nonpeak power periods, while the sliding-pressure arrangement is more efficient during peak operational periods (because it requires less duct burner fuel consumption to achieve a fixed steam turbine generator output).

Gas Turbine Inlet Air Fogging

Gas turbine inlet air fogging falls into the low-risk, moderate-reward category. Of all the alternatives discussed, inlet fogging requires the lowest up-front capital investment. Inlet fogging had the lowest incremental peak power-generating capacity (approximately 5.5 to 7% on a net plant output basis), second only to evaporative cooling. Of all the alternatives, inlet fogging is the least sensitive to the variations in the economic parameters considered because of its insignifi-

cant impact on nonpeak period plant performance, coupled with its low initial investment and modest gain in incremental peak-period power generation.

Gas Turbine Evaporative Cooling

Traditional gas turbine evaporative cooling also falls into the low-risk, moderate-reward category. Evaporative cooling requires a somewhat larger capital cost investment than is required for inlet fogging, has a slightly larger negative impact on plant performance than inlet fogging and has the lowest incremental peak power-generating capacity (approximately 3 to 4.7% on a net plant output basis) of all the alternatives described here. The economic trends associated with the evaporative cooling system are similar to those that exist for inlet air fogging; however, evaporative cooling requires a slightly higher incremental peak power energy rate to achieve parity with the base plant arrangement than what is required for inlet air fogging.

Both inlet fogging and evaporative cooling are sensitive to ambient relative humidity. The less moisture in the inlet air entering the gas turbine inlet, the more effective are fogging and evaporative cooling, resulting in a larger increase in peak power-generating capacity. The converse of this is also true.

Gas Turbine Inlet Air Chilling

Gas turbine inlet air chilling for the sole purpose of capturing additional peak-period power revenues falls into a high-risk, high-reward category. Of the alternatives discussed, inlet chilling requires the largest up-front capital cost investment with an incremental peak-period power-generating capacity second only to HRSG duct firing (approximately 9 to 10.8% on a net plant output basis). Inlet air chilling has the highest sensitivity to peak-period operating hours and is

second only to HRSG duct firing in terms of sensitivity to fuel cost.

The purpose of this study has been to determine the most economical peak power-enhancement alternative and as such does not account for any incremental power benefit that could be achieved at the annual average conditions by way of the application of an inlet chilling system. Provided that a load demand exists, inlet air chilling could be utilized to maintain a constant compressor inlet air temperature of 45°F for ambient temperatures greater than 45°F. This would provide an additional economic evaluation benefit of approximately \$3.25 million and would allow inlet air chilling to be reclassified as a moderate-risk, high-reward peak power-enhancement alternative because it would compare favorably with respect to the base overall economic scenarios considered.

Conclusion

Several means are available to enhance combined-cycle performance beyond larger gas turbine sizes and increased cycle complexity. Output enhancements range from those that provide hot-day output improvements (i.e., evaporative cooling, spray intercooling and inlet chilling) to those that can provide higher outputs at all ambient conditions (water injection and supplementary firing). Efficiency enhancements can be achieved through fuel heating and spray intercooling. The final choice requires careful evaluation of many factors, including water availability, maintenance factors, capital cost, operating cost, operating duration and plant dispatch characteristics.

The focal point of this case study is centered on the economic drivers and opportunities that exist in today's market environment. While the economics in today's market are primarily capacity driven as a result of premiums paid for power

generation during relatively short peak-power demand periods, longer-term market predictions should be carefully considered to ensure long-term profitability. As the installed capacity base increases throughout the country, fuel prices escalate and deregulation in the power generation industry becomes more prevalent, it is expected that a renewed emphasis will be placed upon plant efficiency. Thus, the plant designed with moderate increases in capacity today, bearing in mind that efficiency will significantly impact a plant's profitability in the future, could be the overall winner in terms of life-cycle profitability.

References

1. Chin, D, Hermanson, J. C., and Spadaccini, L. J., "Thermal Stability and Heat Transfer Characteristics of Methane and Natural Gas Fuels," Transactions of the ASME Paper 94-GT-390, 1994.
2. Loud, R. L., and Slaterpryce, A.A., "Gas Turbine Inlet Air Treatment," GER 3419A, 1991.
3. Mee, T. R., "Inlet Fogging Augments Power Production," Power Engineering, February 1999.
4. Fisk, R. W., and VanHousen, R. L., "Cogeneration Application Considerations," GER 3430F, 1996.
5. Brooks, F. J., "GE Heavy-Duty Gas Turbine Performance Characteristics," GER3567G, 1996.
6. McNeely, M., "Intercooling for LM6000 Gas Turbines," Diesel and Gas Turbine Worldwide, July-August 1998.
7. Lukas, H., "Power Augmentation through Inlet Cooling," Global Gas Turbine News, Vol. 37, No. 3, 1997.

Glossary

Economic Terms

cost of electricity (COE). Total cost of producing electricity, including fuel, operation and maintenance (O&M), as well as capital return and recovery and other miscellaneous operating expenses.

variable expenses. Costs in producing electricity that are a function of how many hours the plant is operated (fuel, maintenance that is fired hours dependent and consumables).

fixed expenses. Costs in producing electricity that are not functions of how many hours the plant is operated (capital charges, operating staff, administration and property taxes).

energy revenue. Revenues paid for the delivery of energy (kWh or MW hours) to the grid. Note that two energy revenue streams are considered within the economic analysis presented here; one that is a function of the cost of electricity during base load operation and a second that is a function of assumed peak energy rates. Each is a function of the split between base load and peak-load operating hours.

turnkey cost. Price of plant by supplier, ready to operate (typically expressed in either millions of dollars or \$/kW).

total capitalization. Turnkey cost plus owner's cost. Examples include interest during construction (IDC), permitting, land, interconnects and startup costs.

fixed-charge rate (FCR). A simplified representation of the annual cost of borrowed and invested capital. Comparable to a loan repayment rate in that its value (expressed as a percentage of total invested capital), if received each year over the economic life of the project, assures the owner the return of the invested

capital (equity and debt) and a stipulated return on capital. (The typical IPP rate in the United States is 16% for 20 years.)

levelization. Conversion of a series of changing cash flows to an equivalent constant cash flow with an identical net present value (NPV). Extremely use-ful for comparing two or more projects or plant design concepts with different energy and capital cost structures.

Other Terms

risk. The economic risk of any given power-enhancement option taking into account the

performance penalty at base load relative to an optimized plant without enhancement, the capital cost associated with the enhancement option, as well as any additional fuel and O&M costs. Do not confuse economic risk with technology risk.

reward. Potential incremental revenues associated with peak power production. For the purpose of this paper, it equals the net plant power output (at peak load conditions) times (the difference between the cost of electricity and peak energy rate) times (the peak operating hours).

List of Figures

- Figure 1. Potential peak energy rate variation as a function of annual operating hours
- Figure 2. Plant performance trends
- Figure 3. Combined-cycle system performance variation with ambient air temperature
- Figure 4. Psychrometric chart, simplified
- Figure 5. Effect of evaporative cooler on available output – 85% effective
- Figure 6. Media pack cooler design
- Figure 7. Evaporation rate for MS6001 (B) – 85% effective
- Figure 8. Langelier saturation index chart
- Figure 9. Fogger system
- Figure 10. Diagram of LM6000 PC SPRINT™ system
- Figure 11. Inlet cooling process
- Figure 12. Fuel heating functional block diagram
- Figure 13. Standard gas fuel heating system
- Figure 14. Projected fuel/electricity prices
- Figure 15. Projection of fuel prices

List of Tables

- Table 1. STAG system power-enhancement options
- Table 2. Effect of capital investment change on economic evaluation

List of Exhibits

- Exhibit 1. List of performance enhancements
- Exhibit 1a. COE summary across multiple economic scenarios
- Exhibit 1b. COE rankings across multiple economic scenarios
- Exhibit 2. Incremental peak power revenue vs. peak operating hours (by peak power alternatives)
- Exhibit 3. Risk vs. reward trade-off plots [NPV basis]