



GER-4211

GE Power Systems

Gas Turbine Emissions and Control

Rointon Pavri
Gerald D. Moore
GE Energy Services
Atlanta, GA

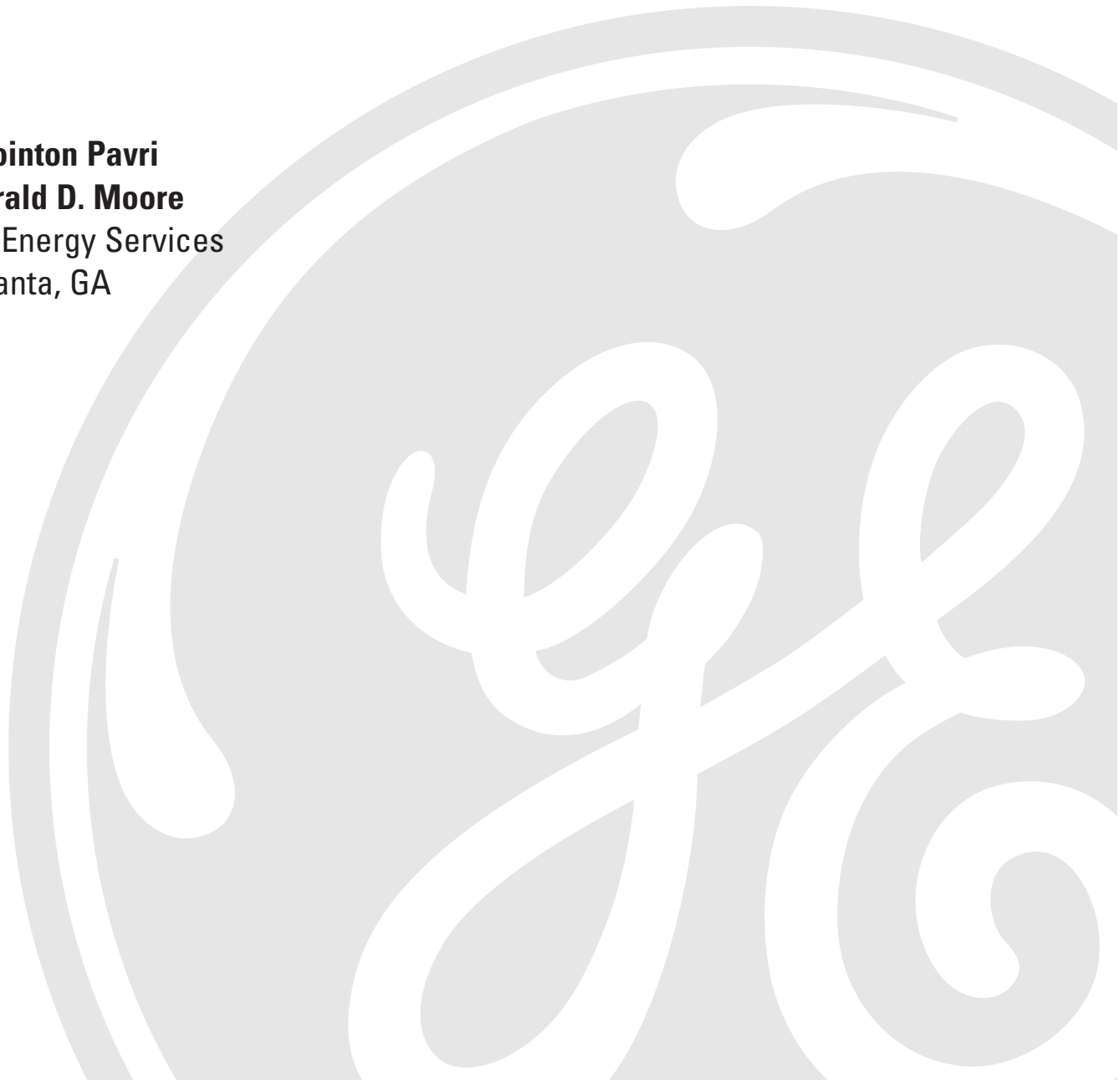

Gas Turbine Emissions and Control

Contents

Introduction	1
Emissions Characteristics of Conventional Combustion Systems	1
Nitrogen Oxides	2
Carbon Monoxide	3
Unburned Hydrocarbons	5
Sulfur Oxides	6
Particulates	7
Smoke	8
Dry Emissions Estimates at Base Load	8
Dry Emissions Estimates at Part Load	8
Simple-Cycle Turbines	8
Exhaust Heat Recovery Turbines	12
Other NO_x Influences	13
Emission Reduction Techniques	16
Nitrogen Oxides Abatement	16
Lean Head End (LHE) Combustion Liners	17
Water/Steam Injection	18
Carbon Monoxide Control	22
Unburned Hydrocarbons Control	24
Particulate and Smoke Reduction	24
Water/Steam Injection Hardware	25
Minimum NO_x Levels	27
Maintenance Effects	29
Performance Effects	29
Summary	30
List of Figures	31
List of Tables	32

Gas Turbine Emissions and Control

Introduction

Worldwide interest in gas turbine emissions and the enactment of Federal and State regulations in the United States have resulted in numerous requests for information on gas turbine exhaust emission estimates and the effect of exhaust emission control methods on gas turbine performance. This paper provides nominal estimates of existing gas turbine exhaust emissions as well as emissions estimates for numerous gas turbine modifications and uprates. (For site-specific emissions values, customers should contact GE.) Additionally, the effects of emission control methods are provided for gas turbine cycle performance and recommended turbine inspection intervals. Emission control methods vary with both internal turbine and external exhaust system emission control. Only the internal gas turbine emission control methods — lean head end liners and water/steam injection — will be covered in this paper.

In the early 1970s when emission controls were originally introduced, the primary regulated gas turbine emission was NO_x . For the relatively low levels of NO_x reduction required in the 1970s, it was found that injection of water or steam into the combustion zone would produce the desired NO_x level reduction with minimal detrimental impact to the gas turbine cycle performance or parts lives. Additionally, at the lower NO_x reductions the other exhaust emissions generally were not adversely affected. Therefore GE has supplied NO_x water and steam injection systems for this application since 1973.

With the greater NO_x reduction requirements imposed during the 1980s, further reductions in NO_x by increased water or steam injection began to cause detrimental effects to the gas turbine cycle performance, parts lives and inspection criteria. Also, other exhaust emis-

sions began to rise to measurable levels of concern. Based on these factors, alternative methods of emission controls have been developed:

- Internal gas turbine
 - Multiple nozzle quiet combustors introduced in 1988
 - Dry Low NO_x combustors introduced in 1990
- External
 - Exhaust catalysts

This paper will summarize the current estimated emissions for existing gas turbines and the effects of available emission control techniques (liner design and water/steam injection) on gas turbine emissions, cycle performance, and maintenance inspection intervals. The latest technology includes Dry Low NO_x and catalytic combustion. These topics are covered in other GERs.

Emissions Characteristics of Conventional Combustion Systems

Typical exhaust emissions from a stationary gas turbine are listed in *Table 1*. There are two distinct categories. The major species (CO_2 , N_2 , H_2O , and O_2) are present in percent concentrations. The minor species (or pollutants) such as CO, UHC, NO_x , SO_x , and particulates are present in parts per million concentrations. In general, given the fuel composition and machine operating conditions, the major species compositions can be calculated. The minor species, with the exception of total sulfur oxides, cannot. Characterization of the pollutants requires careful measurement and semi-theoretical analysis.

The pollutants shown in *Table 1* are a function of gas turbine operating conditions and fuel composition. In the following sections, each pollutant will be considered as a function of

Major Species	Typical Concentration (% Volume)	Source
Nitrogen (N ₂)	66 - 72	Inlet Air
Oxygen (O ₂)	12 - 18	Inlet Air
Carbon Dioxide (CO ₂)	1 - 5	Oxidation of Fuel Carbon
Water Vapor (H ₂ O)	1 - 5	Oxidation of Fuel Hydrogen
Minor Species Pollutants	Typical Concentration (PPMV)	Source
Nitric Oxide (NO)	20 - 220	Oxidation of Atmosphere Nitrogen
Nitrogen Dioxide (NO ₂)	2 - 20	Oxidation of Fuel-Bound Organic Nitrogen
Carbon Monoxide (CO)	5 - 330	Incomplete Oxidation of Fuel Carbon
Sulfur Dioxide (SO ₂)	Trace - 100	Oxidation of Fuel-Bound Organic Sulfur
Sulfur Trioxide (SO ₃)	Trace - 4	Oxidation of Fuel-Bound Organic Sulfur
Unburned Hydrocarbons (UHC)	5 - 300	Incomplete Oxidation of Fuel or Intermediates
Particulate Matter Smoke	Trace - 25	Inlet Ingestion, Fuel Ash, Hot-Gas-Path Attrition, Incomplete Oxidation of Fuel or Intermediates

Table 1. Gas turbine exhaust emissions burning conventional fuels

operating conditions under the broad divisions of gaseous and liquid fuels.

Nitrogen Oxides

Nitrogen oxides (NO_x = NO + NO₂) must be divided into two classes according to their mechanism of formation. Nitrogen oxides formed from the oxidation of the free nitrogen in the combustion air or fuel are called “thermal NO_x.” They are mainly a function of the stoichiometric adiabatic flame temperature of the fuel, which is the temperature reached by burning a theoretically correct mixture of fuel and air in an insulated vessel.

The following is the relationship between combustor operating conditions and thermal NO_x production:

- NO_x increases strongly with fuel-to-air ratio or with firing temperature
- NO_x increases exponentially with combustor inlet air temperature

- NO_x increases with the square root of the combustor inlet pressure
- NO_x increases with increasing residence time in the flame zone
- NO_x decreases exponentially with increasing water or steam injection or increasing specific humidity

Emissions which are due to oxidation of organically bound nitrogen in the fuel—fuel-bound nitrogen (FBN)—are called “organic NO_x.” Only a few parts per million of the available free nitrogen (almost all from air) are oxidized to form nitrogen oxide, but the oxidation of FBN to NO_x is very efficient. For conventional GE combustion systems, the efficiency of conversion of FBN into nitrogen oxide is 100% at low FBN contents. At higher levels of FBN, the conversion efficiency decreases.

Organic NO_x formation is less well understood than thermal NO_x formation. It is important to note that the reduction of flame temperatures

Gas Turbine Emissions and Control

to abate thermal NO_x has little effect on organic NO_x . For liquid fuels, water and steam injection actually increases organic NO_x yields. Organic NO_x formation is also affected by turbine firing temperature. The contribution of organic NO_x is important only for fuels that contain significant amounts of FBN such as crude or residual oils. Emissions from these fuels are handled on a case-by-case basis.

Gaseous fuels are generally classified according to their volumetric heating value. This value is useful in computing flow rates needed for a given heat input, as well as sizing fuel nozzles, combustion chambers, and the like. However, the stoichiometric adiabatic flame temperature is a more important parameter for characterizing NO_x emission. *Table 2* shows relative thermal NO_x production for the same combustor burning different types of fuel. This table shows the NO_x relative to the methane NO_x based on adiabatic stoichiometric flame temperature. The gas turbine is controlled to approximate constant firing temperature and the products of combustion for different fuels affect the reported NO_x correction factors. Therefore, *Table 2* also shows columns for relative NO_x values calculated for different fuels for the same combustor and constant firing temperature relative to the NO_x for methane.

Typical NO_x performance of the MS7001EA, MS6001B, MS5001P, and MS5001R gas turbines

burning natural gas fuel and No. 2 distillate is shown in *Figures 1–4* respectively as a function of firing temperature. The levels of emissions for No. 2 distillate oil are a very nearly constant fraction of those for natural gas over the operating range of turbine inlet temperatures. For any given model of GE heavy-duty gas turbine, NO_x correlates very well with firing temperature.

Low-Btu gases generally have flame temperatures below $3500^\circ\text{F}/1927^\circ\text{C}$ and correspondingly lower thermal NO_x production. However, depending upon the fuel-gas clean-up train, these gases may contain significant quantities of ammonia. This ammonia acts as FBN and will be oxidized to NO_x in a conventional diffusion combustion system. NO_x control measures such as water injection or steam injection will have little or no effect on these organic NO_x emissions.

Carbon Monoxide

Carbon monoxide (CO) emissions from a conventional GE gas turbine combustion system are less than 10 ppmvd (parts per million by volume dry) at all but very low loads for steady-state operation. During ignition and acceleration, there may be transient emission levels higher than those presented here. Because of the very short loading sequence of gas turbines, these levels make a negligible contribution to the integrated emissions. *Figure 5* shows typical

Fuel	Stoichiometric Flame Temp.	NO_x (ppmvd/ppmvw-Methane) 1765°F/963°C – 2020°F/1104°C Firing Time	NO_x (ppmvd/ppmvw-Methane) @ 15% O_2 , 1765°F/963°C – 2020°F/1104°C Firing Time
Methane	1.000	1.000/1.000	1.000/1.000
Propane	1.300	1.555/1.606	1.569/1.632
Butane	1.280	1.608/1.661	1.621/1.686
Hydrogen	2.067	3.966/4.029	5.237/5.299
Carbon Monoxide	2.067	3.835/3.928	4.128/0.529
Methanol	0.417-0.617	0.489/0.501	0.516/0.529
No. 2 Oil	1.667	1.567/1.647	1.524/1.614

Table 2. Relative thermal NO_x emissions

Gas Turbine Emissions and Control

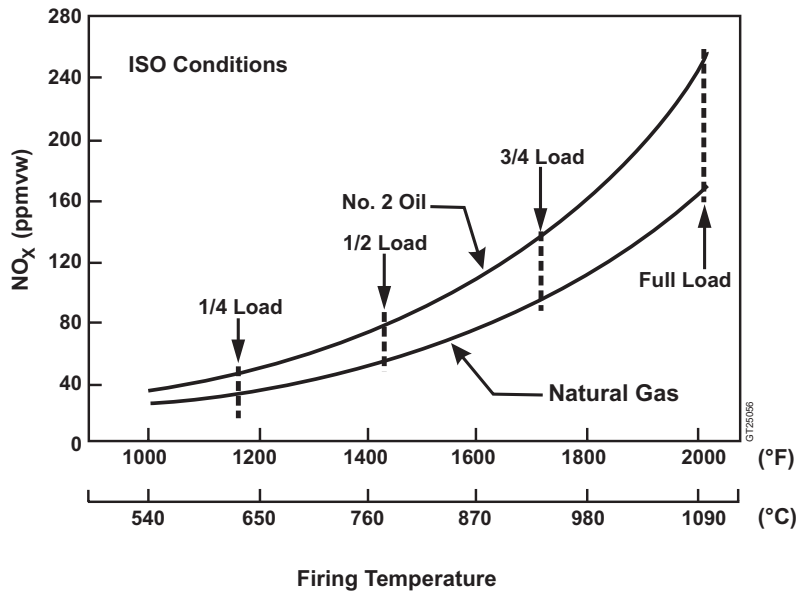

Figure 1. MS7001EA NO_x emissions

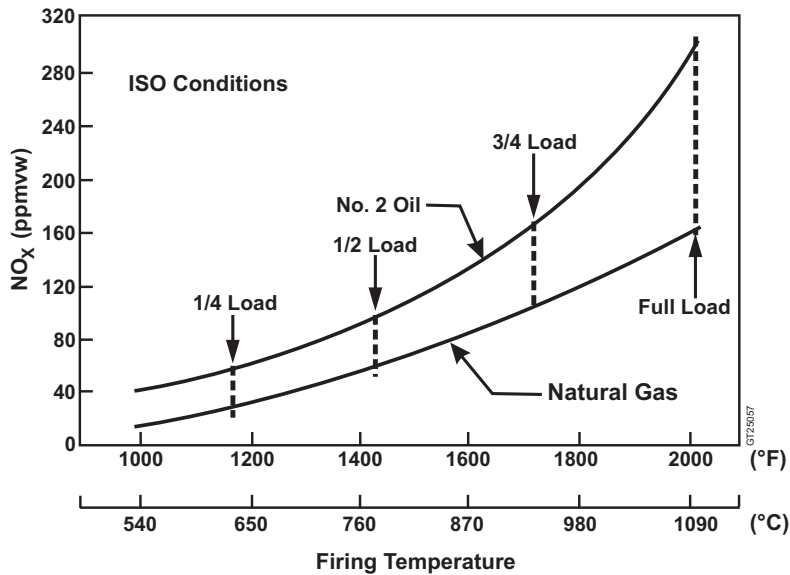

Figure 2. MS6001B NO_x emissions

CO emissions from a MS7001EA, plotted versus firing temperature. As firing temperature is reduced below about 1500°F/816°C the carbon

monoxide emissions increase quickly. This characteristic curve is typical of all heavy-duty machine series.

Gas Turbine Emissions and Control

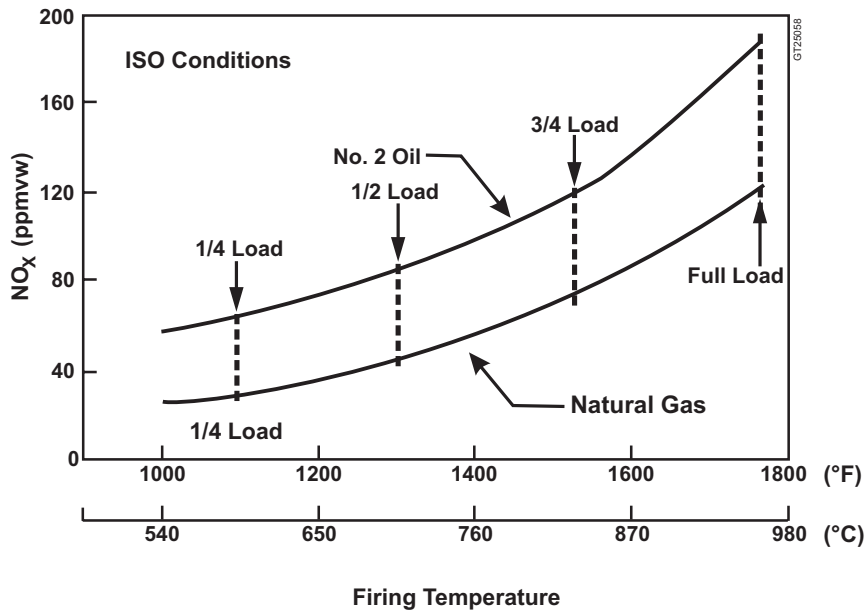

Figure 3. MS5001P A/T NO_x emissions

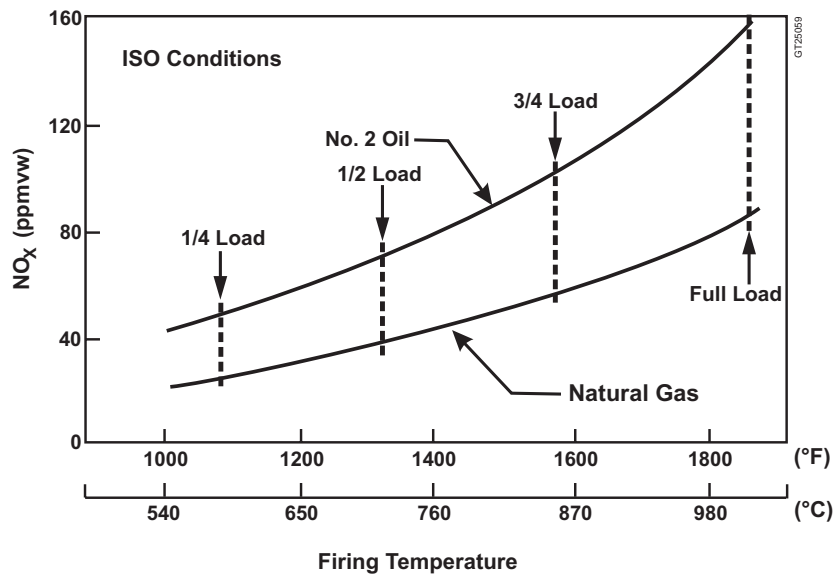

Figure 4. MS5001R A/T NO_x emissions

Unburned Hydrocarbons

Unburned hydrocarbons (UHC), like carbon monoxide, are associated with combustion inefficiency. When plotted versus firing temperature, the emissions from heavy-duty gas turbine

combustors show the same type of hyperbolic curve as carbon monoxide. (See Figure 6.) At all but very low loads, the UHC emission levels for No. 2 distillate and natural gas are less than 7 ppmvw (parts per million by volume wet).

Gas Turbine Emissions and Control

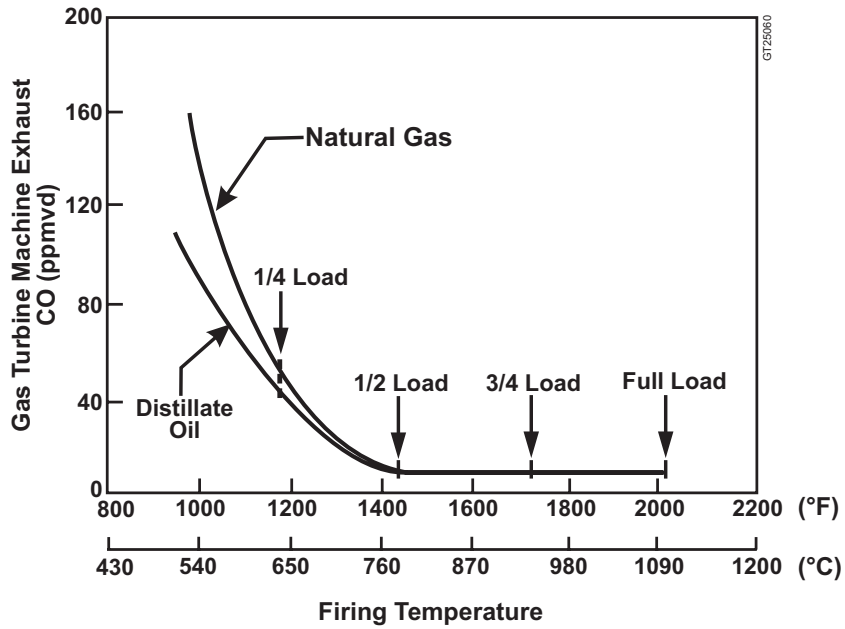

Figure 5. CO emissions for MS7001EA

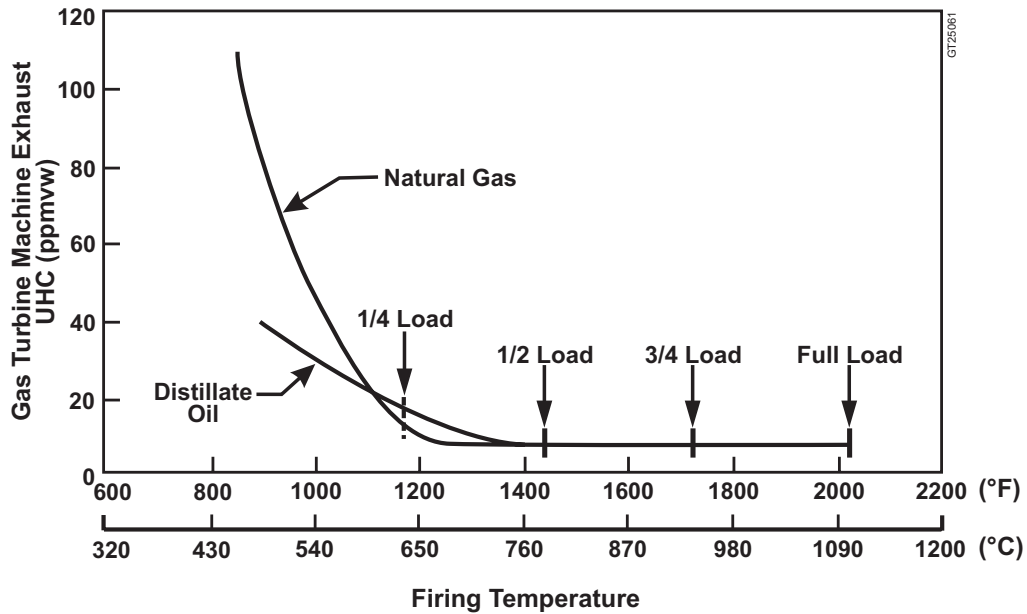

Figure 6. UHC emissions for MS7001EA

Sulfur Oxides

The gas turbine itself does not generate sulfur, which leads to sulfur oxides emissions. All sulfur emissions in the gas turbine exhaust are caused

by the combustion of sulfur introduced into the turbine by the fuel, air, or injected steam or water. However, since most ambient air and injected water or steam has little or no sulfur, the most common source of sulfur in the gas

Gas Turbine Emissions and Control

turbine is through the fuel. Due to the latest hot gas path coatings, the gas turbine will readily burn sulfur contained in the fuel with little or no adverse effects as long as there are no alkali metals present in the hot gas.

GE experience has shown that the sulfur in the fuel is completely converted to sulfur oxides. A nominal estimate of the sulfur oxides emissions is calculated by assuming that all fuel sulfur is converted to SO_2 . However, sulfur oxide emissions are in the form of both SO_2 and SO_3 . Measurements show that the ratio of SO_3 to SO_2 varies. For emissions reporting, GE reports that 95% of the sulfur into the turbine is converted to SO_2 in the exhaust. The remaining sulfur is converted into SO_3 . SO_3 combines with water vapor in the exhaust to form sulfuric acid. This is of concern in most heat recovery applications where the stack exhaust temperature may be reduced to the acid dew point temperature. Additionally, it is estimated that 10% by weight of the SO_x generated is sulfur mist. By

using the relationships above, the various sulfur oxide emissions can be easily calculated from the fuel flow rate and the fuel sulfur content as shown in *Figure 7*.

There is currently no internal gas turbine technique available to prevent or control the sulfur oxides emissions from the gas turbine. Control of sulfur oxides emissions has typically required limiting the sulfur content of the fuel, either by lower sulfur fuel selection or fuel blending with low sulfur fuel.

Particulates

Gas turbine exhaust particulate emission rates are influenced by the design of the combustion system, fuel properties and combustor operating conditions. The principal components of the particulates are smoke, ash, ambient non-combustibles, and erosion and corrosion products. Two additional components that could be considered particulate matter in some localities are sulfuric acid and unburned hydrocarbons that are liquid at standard conditions.

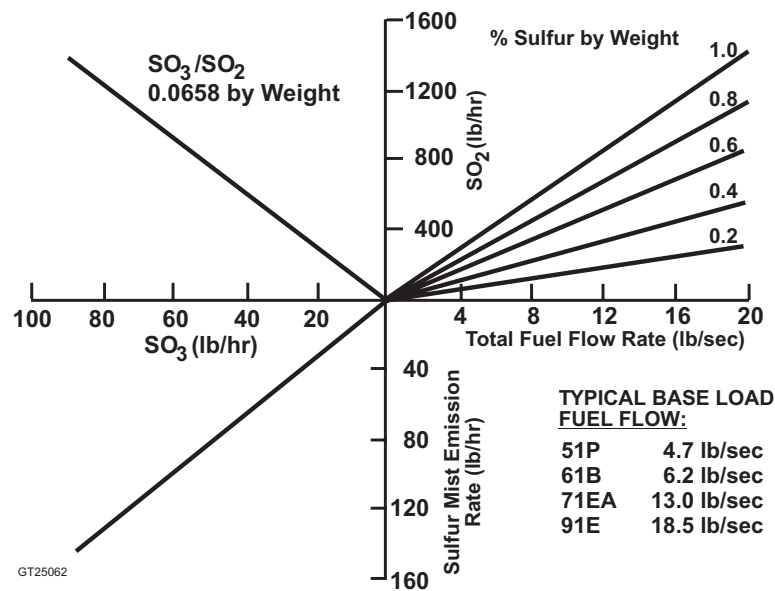

Figure 7. Calculated sulfur oxide and sulfur emissions

Smoke

Smoke is the visible portion of filterable particulate material. The GE combustor design coupled with air atomization of liquid fuels has resulted in a nonvisible plume over the gas turbine load range for a wide variety of fuels. The GE smoke-measuring unit is the Von Brand Reflective Smoke Number (GEVBRNS). If this number is greater than 93 to 95 for the MS7001E, then the plume will not be visible. For liquid fuels, the GEVBRNS is a function of the hydrogen content of the fuel. For natural gas fuel, the smoke number is essentially 99 to 100 over the load range and visible smoke is not present.

Dry Emissions Estimates at Base Load

The ISO non-abated full load emissions estimates for the various GE heavy-duty gas turbine models are provided in *Table 3*. The natural gas and #2 distillate fuel emission estimates shown are for thermal NO_x, CO, UHC, VOC, and particulates. For reporting purposes, all particu-

lates are also reported as PM-10. Therefore PM-10 is not shown in the tables. The nominal full rated firing temperature for each gas turbine model is also shown in *Table 3*.

As can be easily seen in the table, at base load without NO_x abatement, the emissions of CO, UHC, VOC, and particulates are quite low. The estimated values of NO_x vary between gas turbine designs and generally increase with the frame size firing temperature.

Dry Emissions Estimates at Part Load

Simple-Cycle Turbines

At turbine outputs below base load the emissions change from the values given in *Table 3*. These changes are affected by the turbine configuration and application and in some cases by the turbine controls.

Single-shaft gas turbines with non-modulating inlet guide vanes operating at constant shaft speed have part load emissions characteristics which are easily estimated. For these turbines

Single Shaft Units Model	Firing Temp. F/C	Dry (Non-Abated)		H ₂ O/Steam Inj.	
		Gas	Dist.	Gas (FG1A/FG1B)	Gas (FG1C/FG1F)
MS5001P	1730/943	128	195	25	42
MS5001P-N/T	1765/963	142	211	25	42
MS6001B	2020/1104	161	279	25	65/42
MS7001B	1840/1004	109	165	25	42
MS7001B Option 3	1965/1074	124	191	25	42
MS7001B Option 4	2020/1104	132	205	25	42
MS7001EA	2020/1104	160	245	25	42
MS9001B	1940/1060	109	165	42	65
MS9001B Option 3	1965/1074	124	191	42	65
MS9001B Option 4	2020/1104	132	205	42	65
MS9001E	2020/1104	157	235	42	65
MS9001E	2055/1124	162	241	42	65
6FA	2350/1288				
7FA	2400/1316				
7FA	2420/1327				
9FA	2350/1288				
Two Shaft Units* Model	Firing Temp. F/C	Dry (Non-Abated)		H ₂ O/Steam Inj.	
		S.C.	R.C.**	S.C.	S.C.
MS3002F	1575/1625/857/885	115	201	42	50
MS3002J	1730/943	128	217	42	50
MS3002J-N/T	1770/968	140	236	42	50
MS5002	1700/927	125	220	42	50
MS5002B-N/T	1770/966	137	255	42	50

* S.C. = Simple Cycle and R.C. = Regenerative Cycle
 ** Two-Shaft NO_x Levels Are All on Gas Fuel

GT23288E

Table 3. NO_x emission levels @ 15% O₂ (ppmvd)

Gas Turbine Emissions and Control

the NO_x emissions vary exponentially with firing temperature as shown previously in *Figures 1–4*. The load points for each turbine are also marked on these figures. Due to the conversions used in the various NO_x reporting methods, the information in *Figures 1–4* has been redrawn in *Figures 8–11*. This information shows the estimated ISO NO_x emissions on a ppmvd @ 15% O₂, ppmvw, and lb/hour basis for MS7001EA, MS6001B, MS5001P and MS5001R. In these figures, the nominal peak load firing temperature point is also given. It should be noted that in some cases the NO_x ppmvd@15% O₂ reporting method can cause number values to increase as load is reduced (e.g., see the MS5001P A/T in *Figure 10*.) Since the GE MS9001E gas turbine is a scaled version of the MS7001E gas turbine, the MS7001E gas turbine figures can be used as an estimate of MS9001E gas turbine part load emissions characteristics. Many gas turbines have variable inlet guide vanes that are modulated closed at part load conditions in order to maintain higher exhaust

temperatures for waste heat recovery equipment located in the gas turbine exhaust. As shown in *Figure 12*, closing the inlet guide vanes has a slight effect on the gas turbine NO_x emissions. *Figure 12* shows the effect on NO_x ppmvd @ 15% O₂ and *Figure 13* shows the effect on NO_x lb/hr. The figures show both MS5001P and MS7001E characteristics. They also show normalized NO_x (% of base load value) vs. % base load. Curves are shown for load reductions by either closing the inlet guide vanes while maintaining exhaust temperature control and for load reductions by reducing firing temperature while keeping the inlet guide vanes fully open.

Mechanical drive gas turbines typically vary the output load shaft speed in order to adjust the turbine output to match the load equipment characteristic. Single-shaft gas turbines operating on exhaust temperature control have a maximum output NO_x emissions characteristic vs. turbine shaft speed, as shown in *Figure 14* for an MS5001R Advanced Technology uprated tur-

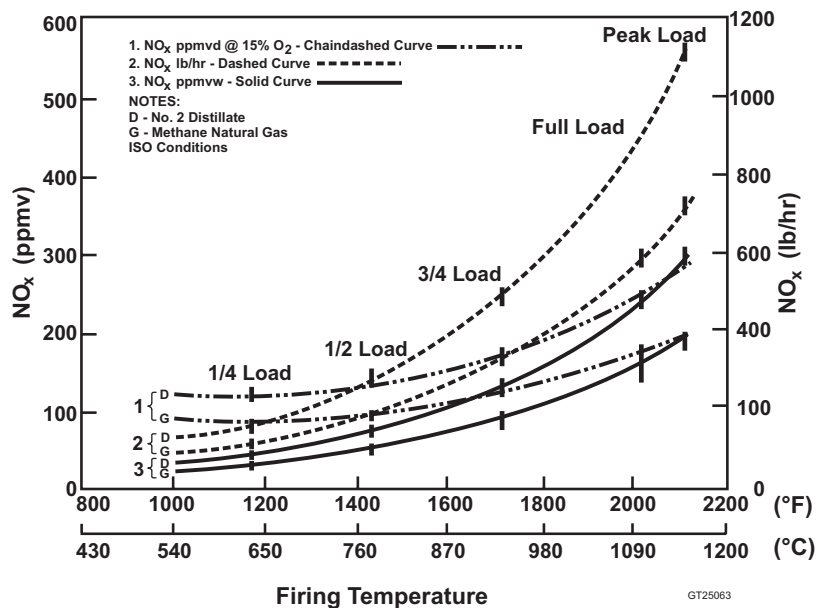

Figure 8. MS7001EA NO_x emissions

Gas Turbine Emissions and Control

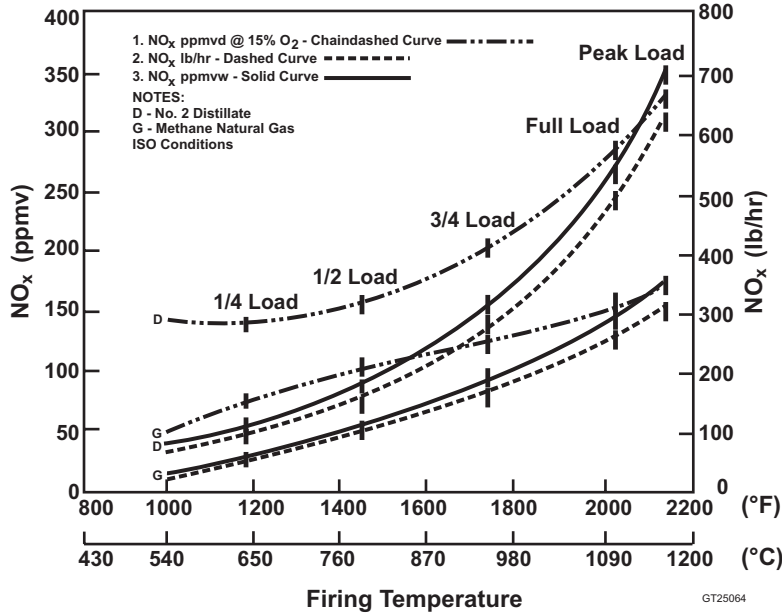

Figure 9. MS6001B NO_x emissions

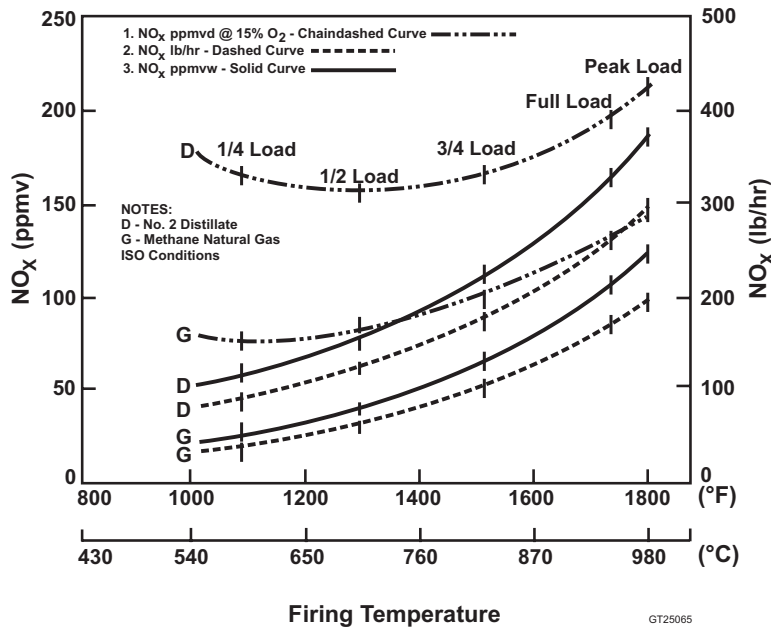

Figure 10. MS5001P A/T NO_x emissions

bine. The characteristic shown is primarily due to the gas turbine exhaust temperature control system and the turbine thermodynamics. As seen in *Figure 14*, as the turbine output shaft

speed is reduced below 100%, NO_x emissions decrease directly with turbine shaft speed. As the speed decreases, the exhaust temperature increases till the exhaust component tempera-

Gas Turbine Emissions and Control

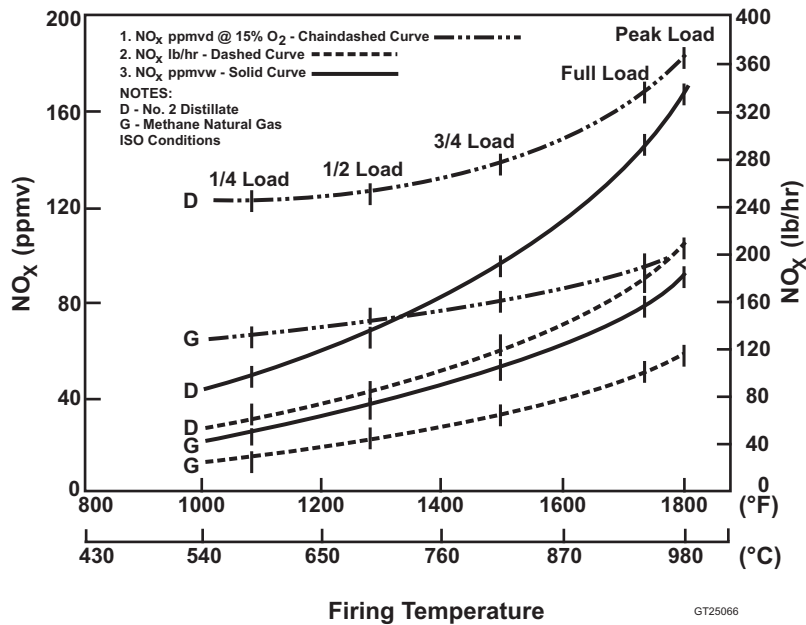

Figure 11. MS5001R A/T NO_x emissions

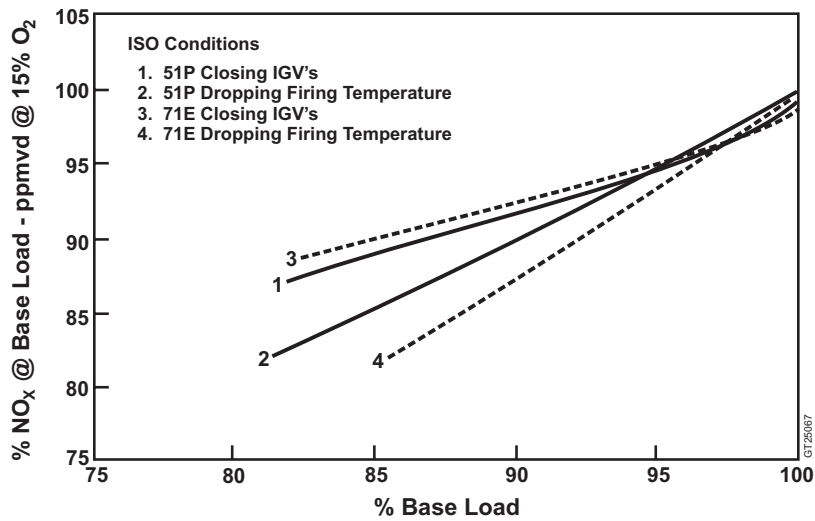

Figure 12. Inlet guide vane effect on NO_x ppmvd @ 15% O₂ vs. load

ture limit is reached. Once the exhaust isothermal limit is reached, the variation of NO_x emissions with speed will become greater. In *Figure 16* this exhaust isothermal temperature limit is reached at approximately 84% speed. Two-shaft gas turbines also vary the output turbine shaft

speed with load conditions. However the gas turbine compressor shaft and combustor operating conditions are controlled independent of the output shaft speed. On a two-shaft gas turbine, if the gas turbine compressor shaft speed is held constant by the control system while on exhaust

Gas Turbine Emissions and Control

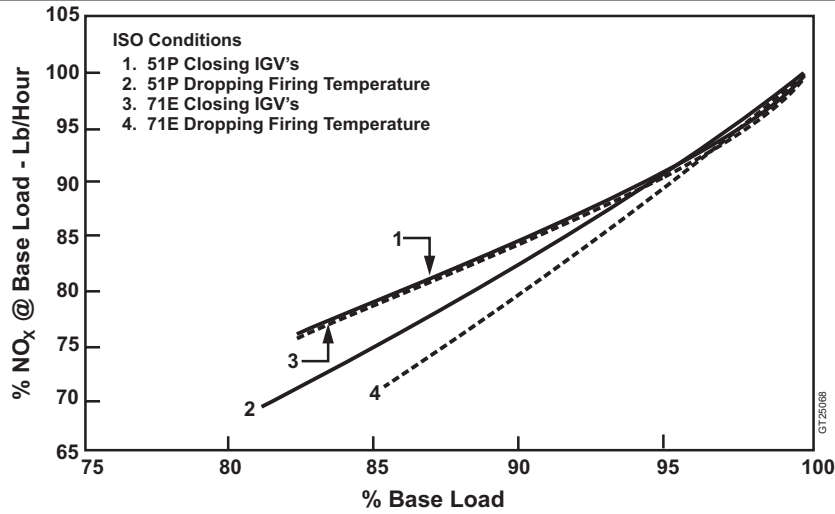

Figure 13. Inlet guide vane effect on NO_x lb/hour vs. load

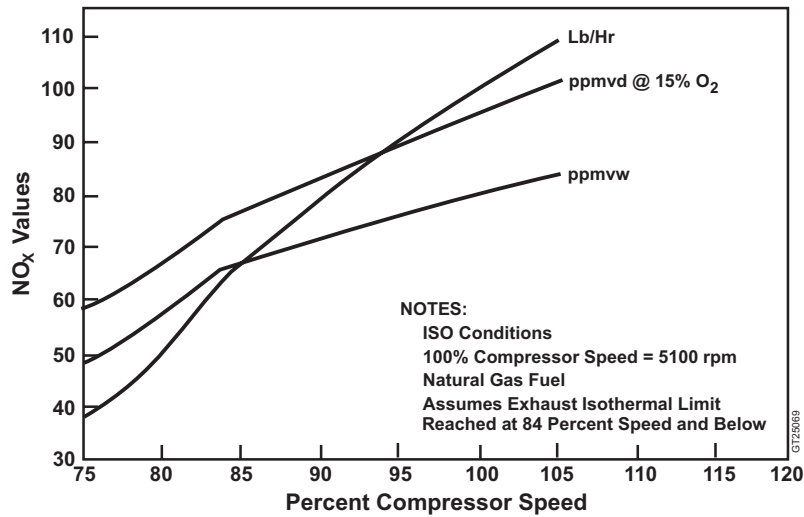

Figure 14. MS5001R A/T NO_x emissions vs. shaft speed

temperature control, the NO_x emissions are not affected by the load turbine shaft speed.

Exhaust Heat Recovery Turbines

Regenerative cycle and waste heat recovery two-shaft gas turbines are normally controlled to operate the gas turbine compressor at the minimum speed allowable for the desired load output. As load is increased from minimum, the

gas turbine compressor speed is held at minimum until the turbine exhaust temperature reaches the temperature control curve. With further increase in load, the control system will increase the gas turbine compressor speed while following the exhaust temperature control curve. If the turbine has modulated inlet guide vanes, the inlet guide vanes will open first when the exhaust temperature control curve is

Gas Turbine Emissions and Control

reached, and then, once the inlet guide vanes are fully open, the gas turbine compressor speed will be increased.

Figure 15 shows the NO_x characteristic of a regenerative cycle MS3002J gas turbine at ISO conditions. Initially, as load is increased, NO_x increases with firing temperature while the gas turbine compressor is operating at minimum speed. For the turbine shown, the exhaust isothermal temperature control is reached at

The NO_x vs. load characteristic is similar to the MS3002J. However, this design turbine will operate at low load with the inlet guide vanes partially closed and at minimum operating gas turbine compressor shaft speed. During initial loading, NO_x increases with firing temperature. When the exhaust temperature control system isothermal temperature limit is reached the inlet guide vanes are modulated open as load is increased. At approximately 90% load the gas

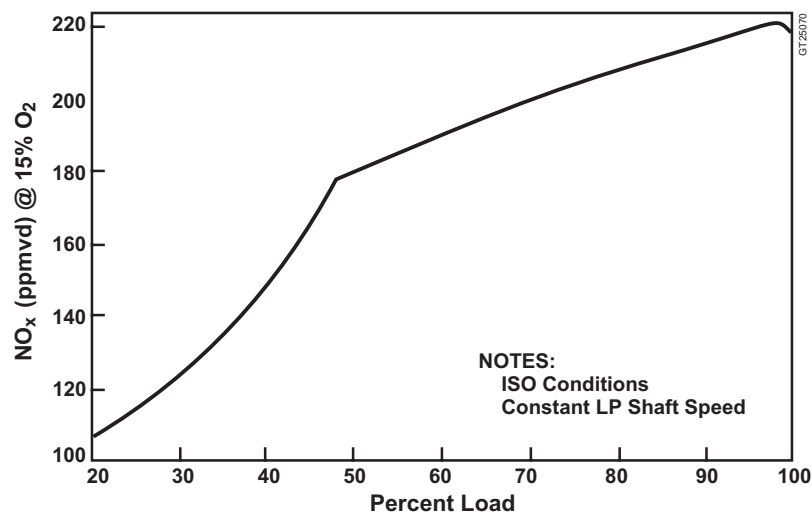

Figure 15. MS3002J regenerative NO_x vs. load

approximately 48% load. The gas turbine compressor shaft speed is then increased by the control system for further increases in load up to the 100% load point. At approximately 96% load, the gas turbine exhaust temperature control curve begins to limit exhaust temperature below the isothermal exhaust temperature due to the increasing airflow through the turbine and the NO_x values are reduced by the characteristic shown.

For a typical regenerative cycle MS5002B Advanced Technology gas turbine with modulated inlet guide vanes, the curve of NO_x vs. load at ISO conditions is shown in Figure 16.

turbine exhaust temperature control curve begins to limit exhaust temperature below the isothermal exhaust temperature due to the increasing airflow through the turbine and the NO_x values are reduced. At approximately 91.5% load for this turbine calculation, the inlet guide vanes are fully open and further increases in load are accomplished by increasing the gas turbine compressor speed resulting in the NO_x reduction as shown.

Other NO_x Influences

The previous sections of this paper consider the internal gas turbine design factors which influ-

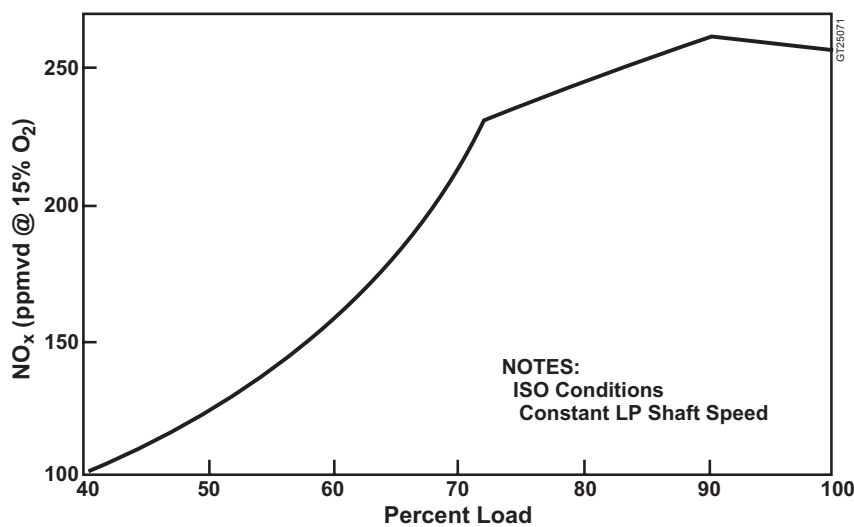

Figure 16. MS5002B A/T regenerative NO_x vs. load

ence emissions generation. There are many external factors to the gas turbine which impact the formation of NO_x emissions in the gas turbine cycle. Some of these factors will be discussed below. In all figures under this topic, the NO_x is presented as a percentage value where 100% represents the thermal ISO NO_x value for the turbine operating on base temperature control. For all figures except for the regenerator changes discussed, the curves drawn represent a single “best fit” line through the calculated characteristics for frame 3, 5, 6, 7, and 9 gas turbines. However, the characteristics shape that is shown is the same for all turbines.

Ambient Pressure. NO_x ppm emissions vary almost directly with ambient pressure. *Figure 17* provides an approximation for the ambient pressure effect on NO_x production on a lb/hr basis and on a ppmvd @ 15% O₂ basis. This figure is at constant 60% relative humidity. It should be noted that specific humidity varies with ambient pressure and that this variation is also included in the *Figure 18* curves.

Ambient Temperature. Typical NO_x emissions variation with ambient temperature is shown in

Figure 18. This figure is drawn at constant ambient pressure and 60% relative humidity with the gas turbine operating constant gas turbine firing temperature. For an operating gas turbine the actual NO_x characteristic is directly influenced by the control system exhaust temperature control curve, which can change the slope of the curves. The typical exhaust temperature control curve used by GE is designed to hold constant turbine firing temperature in the 59°F/15°C to 90°F/32°C ambient temperature range. The firing temperature with this typical curve causes under-firing of approximately 20°F/11°C at 0°F/−18°C ambient, and approximately 10°F/6°C under-firing at 120°F/49°C ambient. Factors such as load limits, shaft output limits, and exhaust system temperature limits are also not included in the *Figure 18* curves. Based on the actual turbine exhaust temperature control curve used and other potential limitations that reduce firing temperature, the estimated NO_x emissions for an operating gas turbine are typically less than the values shown in *Figure 18* at both high and low ambients.

Relative Humidity. This parameter has a very

Gas Turbine Emissions and Control

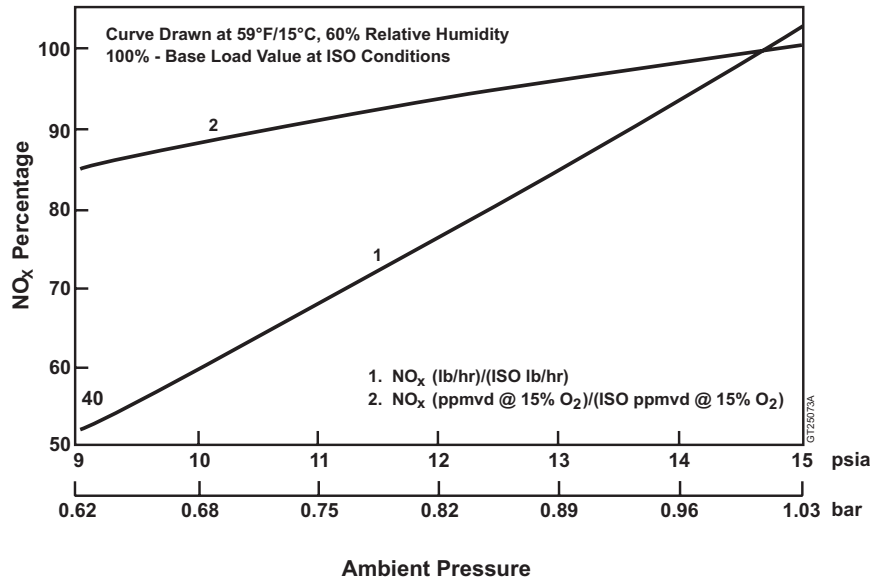

Figure 17. Ambient pressure effect on NO_x Frames 5, 6 and 7

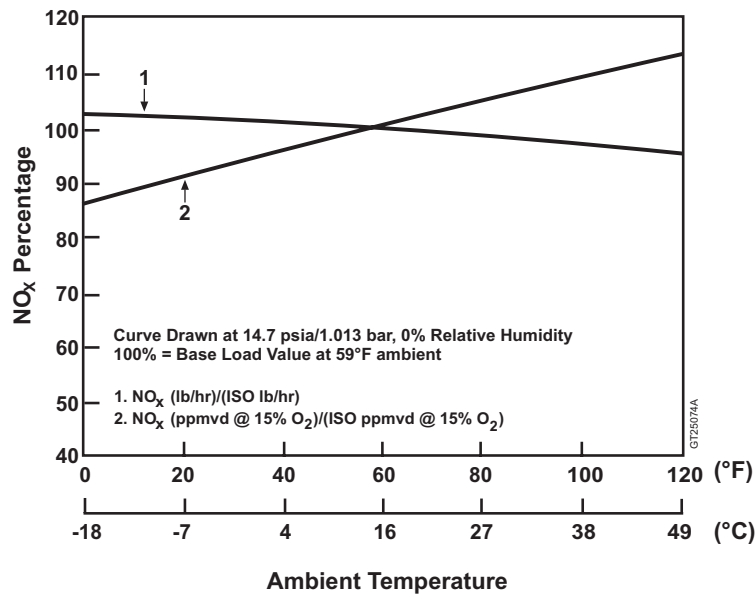

Figure 18. Ambient temperature effect on NO_x Frames 5, 6 and 7
0% Relative Humidity

strong impact on NO_x. The ambient relative humidity effect on NO_x production at constant ambient pressure of 14.7 psia and ambient temperatures of 59°F/15°C and 90°F/32°C is shown in *Figure 19*.

The impact of other parameters such as inlet/exhaust pressure drops, regenerator characteristics, evaporative/inlet coolers, etc., are similar to the ambient parameter effects described above. Since these parameters are

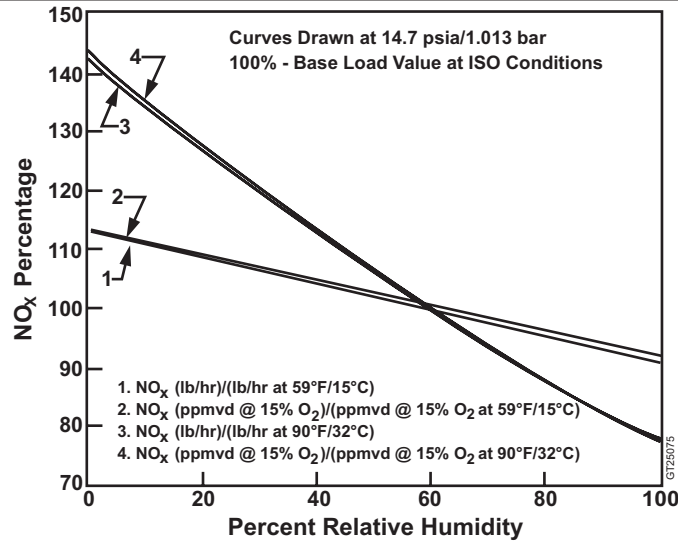

Figure 19. Relative humidity effect on NO_x Frames 5, 6 and 7

usually unit specific, customers should contact GE for further information.

Power Augmentation Steam Injection. The effect of power augmentation steam injection on gas turbine NO_x emissions is similar to NO_x steam injection on a ppmvw and lb/hr basis. However, only approximately 30% of the power augmentation steam injected participates in NO_x reduction. The remaining steam flows through dilution holes downstream of the NO_x producing area of the combustor. 100% of the power augmentation steam injected is used in the conversion from ppmvw to ppmvd @ 15% O₂.

Emission Reduction Techniques

The gas turbine, generally, is a low emitter of exhaust pollutants because the fuel is burned with ample excess air to ensure complete combustion at all but the minimum load conditions or during start-up. The exhaust emissions of concern and the emission control techniques can be divided into several categories as shown in *Table 4*. Each pollutant emission reduction technique will be discussed in the following sections.

Nitrogen Oxides Abatement

The mechanism on thermal NO_x production was first postulated by Zeldovich. This is shown in *Figure 20*. It shows the flame temperature of distillate as a function of equivalence ratio. This ratio is a measure of fuel-to-air ratio in the combustor normalized by stoichiometric fuel-to-air ratio. At the equivalence ratio of unity, the stoichiometric conditions are reached. The flame temperature is highest at this point. At equivalence ratios less than 1, we have a “lean” combustor. At the values greater than 1, the combustor is “rich.” All gas turbine combustors are designed to operate in the lean region.

Figure 20 shows that thermal NO_x production rises very rapidly as the stoichiometric flame temperature is reached. Away from this point, thermal NO_x production decreases rapidly. This theory then provides the mechanism of thermal NO_x control. In a diffusion flame combustor, the primary way to control thermal NO_x is to reduce the flame temperature.

Gas Turbine Emissions and Control

NO_x	Lean Head End Liner Water or Steam Injection Dry Low NO _x
CO	Combustor Design Catalytic Reduction
UHC & VOC	Combustor Design
SO_x	Control Sulfur in Fuel
Particulates & PM-10	Fuel Composition
Smoke Reduction	Combustor Design - Fuel Composition - Air Atomization
Particulate Reduction	Fuel Composition - Sulfur - Ash

GT25092

Table 4. Emission control techniques

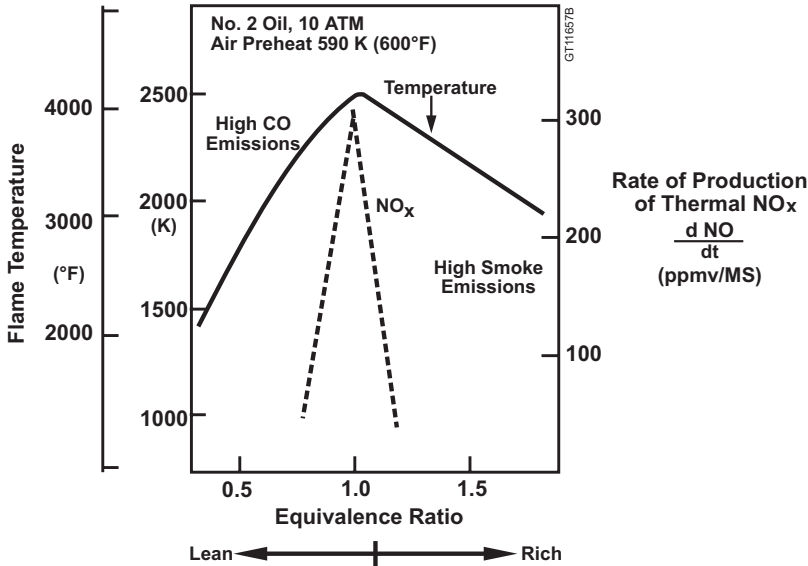

Figure 20. NO_x production rate

Lean Head End (LHE) Combustion Liners

Since the overall combustion system equivalence ratio must be lean (to limit turbine inlet temperature and maximize efficiency), the first efforts to lower NO_x emissions were naturally

directed toward designing a combustor with a leaner reaction zone. Since most gas turbines operate with a large amount of excess air, some of this air can be diverted towards the flame end, which reduces the flame temperature.

Leaning out the flame zone (reducing the flame zone equivalence ratio) also reduces the flame length, and thus reduces the residence time a gas molecule spends at NO_x formation temperatures. Both these mechanisms reduce NO_x . The principle of a LHE liner design is shown in *Figure 21*.

It quickly became apparent that the reduction in primary zone equivalence ratio at full operating conditions was limited because of the large turndown in fuel flow (40 to 1), air flow (30 to 1), and fuel/air ratio (5 to 1) in industrial gas turbines. Further, the flame in a gas turbine is a diffusion flame since the fuel and air are injected directly into the reaction zone. Combustion occurs at or near stoichiometric conditions, and there is substantial recirculation within the reaction zone. These parameters essentially limit the extent of LHE liner technology to a NO_x reduction of 40% at most. Depending upon the liner design, actual reduction achieved varies from 15% to 40%.

Figure 22 compares an MS5001P LHE liner to a standard liner. The liner to the right is the LHE

liner. It has extra holes near the head (flame) end and also has a different louver pattern compared to the standard liner. *Table 5* summarizes all LHE liners designed to date. Field test data on MS5002 simple-cycle LHE liners and MS3002J simple-cycle LHE liners are shown in *Figures 23–25*.

One disadvantage of leaning out the head end of the liner is that the CO emissions increase. This is clear from *Figure 24*, which compares CO between the standard and LHE liner for a MS5002 machine.

Water/Steam Injection

Another approach to reducing NO_x formation is to reduce the flame temperature by introducing a heat sink into the flame zone. Both water and steam are very effective at achieving this goal. A penalty in overall efficiency must be paid for the additional fuel required to heat the water to combustor temperature. However, gas turbine output is enhanced because of the additional mass flow through the turbine. By necessity, the water must be of boiler feedwater qual-

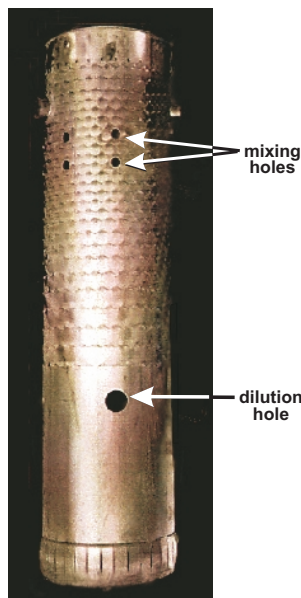

- LHE Liner has same diameter and length as standard liner shown at left.
- The number, diameter, and location of the mixing and dilution holes is different in the LHE liner.
- As a result,
 - more air is introduced in the head end of the LHE combustor
 - NO_x emissions decrease

Figure 21. Standard simple-cycle MS5002 combustion liner



Figure 22. Louvered low NO_x lean head end combustion liners

ity to prevent deposits and corrosion in the hot turbine gas path area downstream of the combustor.

Water injection is an extremely effective means for reducing NO_x formation; however, the combustor designer must observe certain cautions when using this reduction technique. To maximize the effectiveness of the water used, fuel

nozzles have been designed with additional passages to inject water into the combustor head end. The water is thus effectively mixed with the incoming combustion air and reaches the flame zone at its hottest point. In *Figure 26* the NO_x reduction achieved by water injection is plotted as a function of water-to-fuel ratio for an MS7001E machine. Other machines have similar NO_x abatement performance with water injection.

Steam injection for NO_x reduction follows essentially the same path into the combustor head end as water. However, steam is not as effective as water in reducing thermal NO_x. The high latent heat of water acts as a strong thermal sink in reducing the flame temperature.

In general, for a given NO_x reduction, approximately 1.6 times as much steam as water on a mass basis is required for control.

There are practical limits to the amount of water or steam that can be injected into the combustor before serious problems occur. This has been experimentally determined and must be taken into account in all applications if the combustor designer is to ensure long hardware life for the gas turbine user.

Turbine Model	Laboratory Development Completed	First Field Test
S/C MS3002F S/C MS3002G S/C MS3002J	December-98 December-98 April-97	Fall 1999 to be determined March-99
S/C MS5002B, C, & D S/C MS5001 (All Models)	April-97 1986	September-97 Over 130 operating in field
R/C MS3002J R/C MS5002B & C	February-99 February-99	to be determined to be determined

Table 5. Lean head end (LHE) liner development

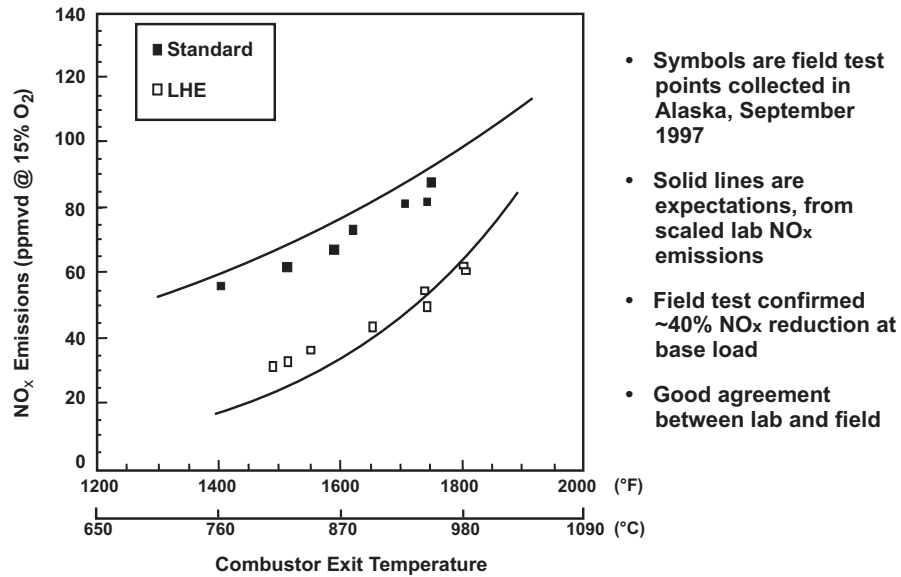

Figure 23. Field test data: simple-cycle MS5002 NO_x

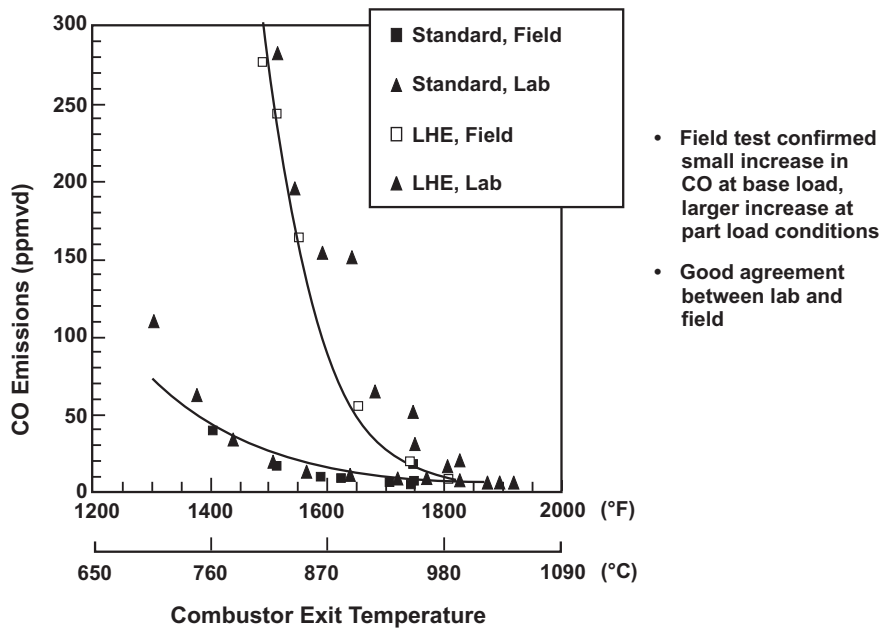

Figure 24. Field test data: simple-cycle MS5002 CO

Injecting water/steam in a combustor affects several parameters:

1. **Dynamic Pressure Activity within the Combustor.** Dynamic pressures can be defined as pressure oscillations within the combustor driven by non-uniform

heat release rate inherent in any diffusion flame or by the weak coupling between heat release rate, turbulence, and acoustic modes. An example of the latter is selective amplification of combustion roar by

Gas Turbine Emissions and Control

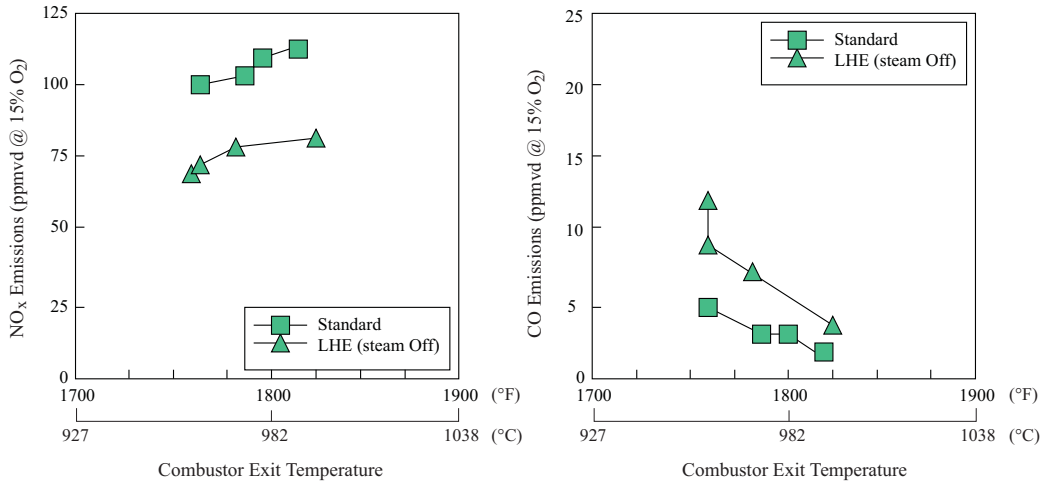

- 30% reduction in NO_x with negligible increase in CO.
- Injecting steam further reduces NO_x.

Figure 25. Field test data: simple-cycle MS3002J with steam injection for power augmentation

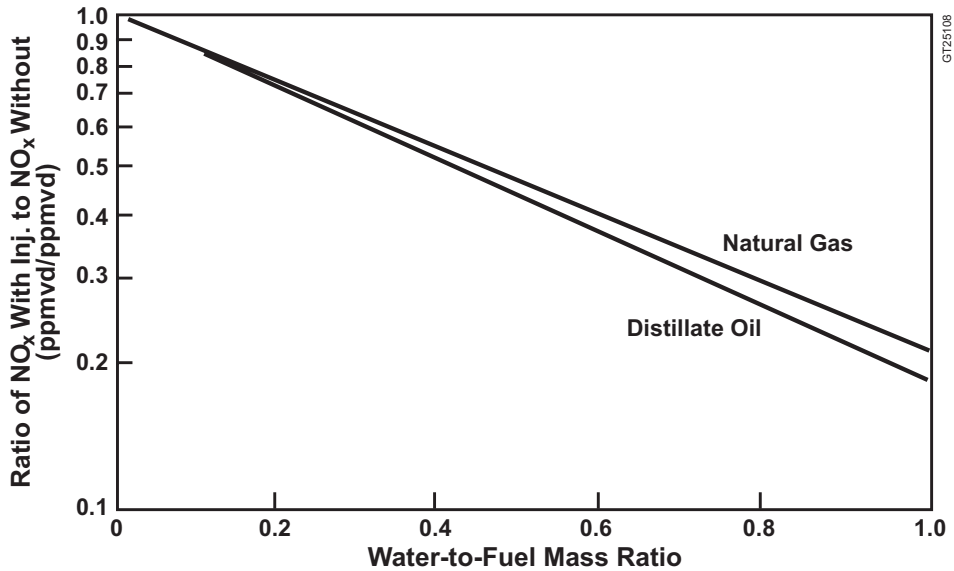

Figure 26. MS7001E NO_x reduction with water injection

the acoustic modes of the duct. Frequencies range from near zero to several hundred hertz. *Figure 27* shows dynamic pressure activity for both water injection and steam injection for an MS7001E combustor. Water

injection tends to excite the dynamic activity more than steam injection. The oscillating pressure loads on the combustion hardware act as vibratory forcing functions and therefore must be minimized to ensure long hardware

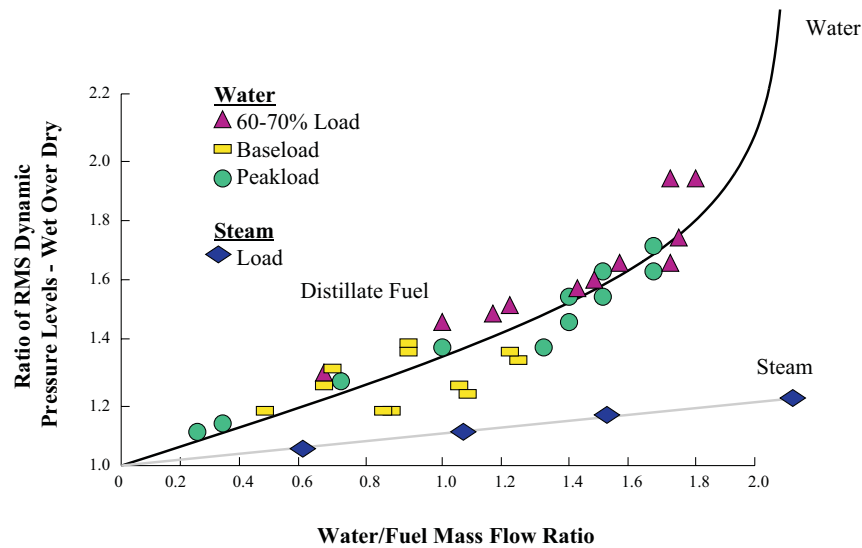

Figure 27. MS7001E combustor dynamic pressure activity

life. Through combustor design modifications such as the addition of a multi-nozzle fuel system, significant reductions in dynamic pressure activity are possible.

2. **Carbon Monoxide Emissions.** As more and more water/steam is added to the combustor, a point is reached at which a sharp increase in carbon monoxide is observed. This point has been dubbed the “knee of the curve”. Once the knee has been reached for any given turbine inlet temperature, one can expect to see a rapid increase in carbon monoxide emissions with the further addition of water or steam. Obviously, the higher the turbine inlet temperature, the more tolerant the combustor is to the addition of water for NO_x control. *Figure 28* shows the relationship of carbon monoxide emissions to water injection for a MS7001B machine for natural gas fuel. *Figure 29* shows the effect of steam

injection on CO emissions for a typical MS7001EA. Unburned hydrocarbons have a similar characteristic with NO_x water or steam injection as carbon monoxide. *Figure 30* shows the MS7001EA gas turbine unburned hydrocarbon versus firing temperature characteristic with steam injection.

3. **Combustion Stability.** Increasing water/steam injection reduces combustor-operating stability.
4. **Blow Out.** With increasing water/steam injection, eventually a point will be reached when the flame will blow out. This point is the absolute limit of NO_x control with water/steam injection.

Carbon Monoxide Control

There are no direct carbon monoxide emission reduction control techniques available within the gas turbine. Basically the carbon monoxide emissions within the gas turbine combustor can be viewed as resulting from incomplete com-

Gas Turbine Emissions and Control

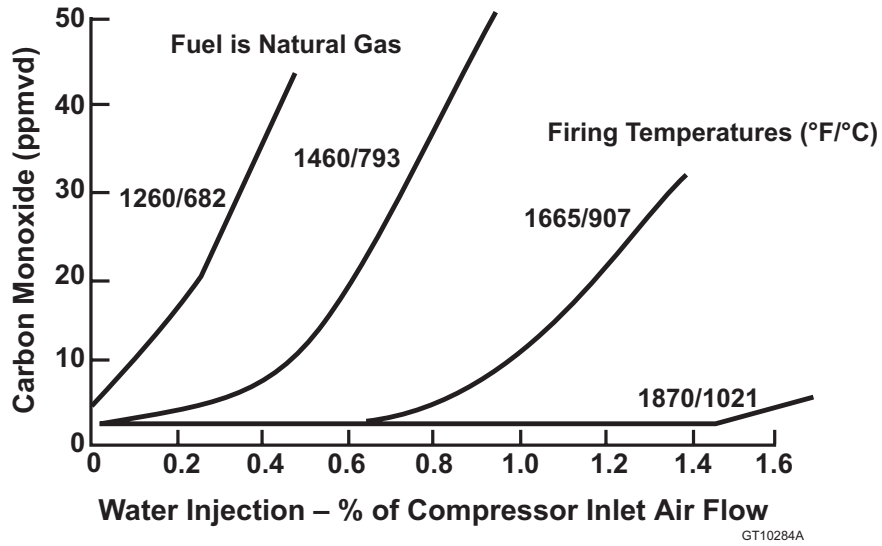

Figure 28. Carbon monoxide vs. water injection effect of firing temperature – MS7001B

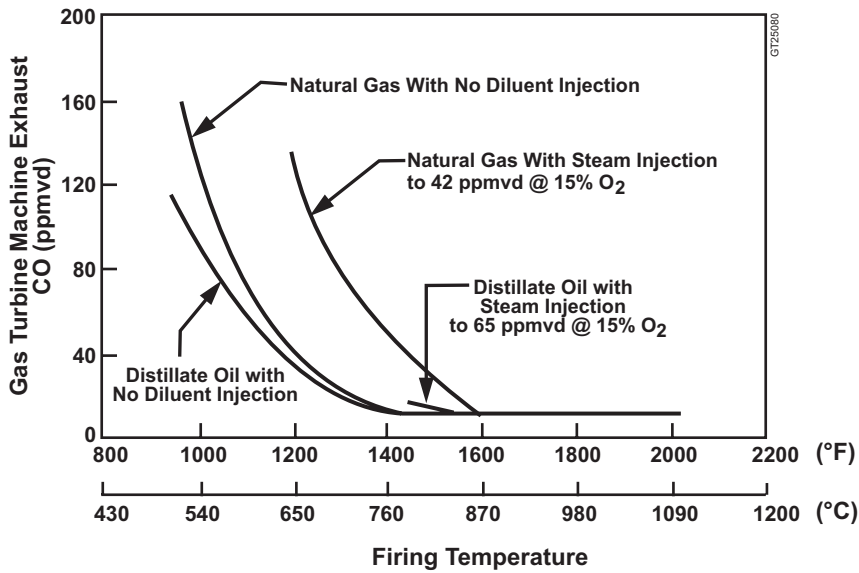

Figure 29. CO emissions for MS7001EA

bustion. Since the combustor design maximizes combustion efficiency, carbon monoxide emissions are minimized across the gas turbine load range of firing temperatures. Reviewing *Figure 5* shows that the carbon monoxide emission levels increase at lower firing temperatures. In some

applications where carbon monoxide emissions become a concern at low loads (firing temperatures), the increase in carbon monoxide can be lowered by:

- reducing the amount of water/steam

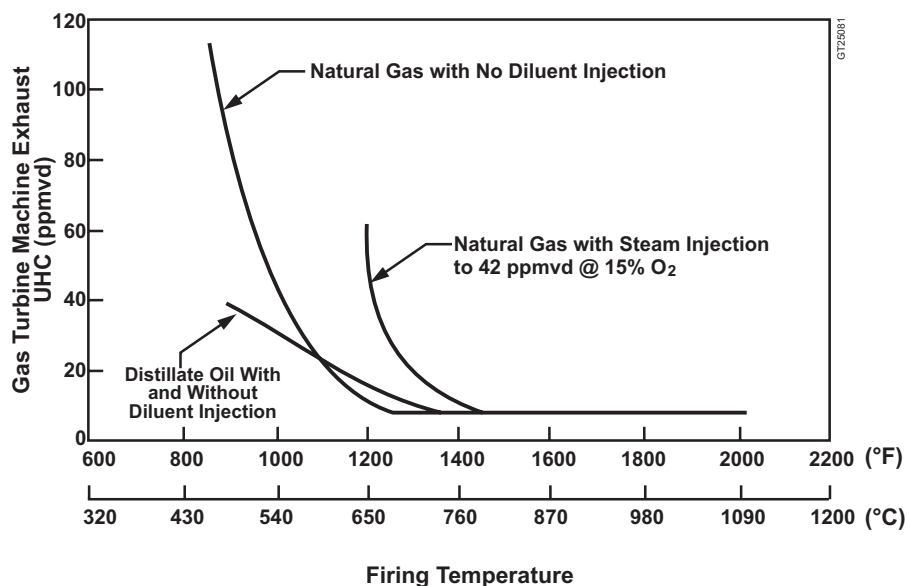

Figure 30. UHC emissions for MS7001EA

injection for NO_x control (if allowed)

– or –

- closing the inlet guide vanes, which will increase the firing temperature for the same load.

Unburned Hydrocarbons Control

Similar to carbon monoxide, there are also no direct UHC reduction control techniques used within the gas turbine. UHCs are also viewed as incomplete combustion, and the combustor is designed to minimize these emissions. The same indirect emissions control techniques can be used for unburned hydrocarbons as for carbon monoxide.

Particulate and Smoke Reduction

Control techniques for particulate emissions with the exception of smoke are limited to control of the fuel composition.

Although smoke can be influenced by fuel composition, combustors can be designed which minimize emission of this pollutant. Heavy fuels

such as crude oil and residual oil have low hydrogen levels and high carbon residue, which increase smoking tendencies. GE has designed heavy-fuel combustors that have smoke performance comparable with those which burn distillate fuel.

Crude and residual fuel oil generally contain alkali metals (Na, K) in addition to vanadium and lead, which cause hot corrosion of the turbine nozzles and buckets at the elevated firing temperatures of today's gas turbine. If the fuel is washed, water soluble compounds (alkali salts) containing the contaminants are removed. Filtration, centrifuging, or electrostatic precipitation are also effective on reducing the solid contaminants in the combustion products.

Contaminants that cannot be removed from the fuel (vanadium compounds) can be controlled through the use of inhibitors. GE uses addition of magnesium to control vanadium corrosion in its heavy-duty gas turbines. These magnesium additives always form ash within the hot gas path components. This process generally

Gas Turbine Emissions and Control

requires control and removal of added ash deposits from the turbine. The additional ash will contribute to the exhaust particulate emissions. Generally, the expected increase can be calculated from an analysis of the particular fuel being burned.

In some localities, condensable compounds such as SO₃ and condensable hydrocarbons are considered particulates. SO₃, like SO₂, can best be minimized by controlling the amount of sulfur in the fuel. The major problem associated with sulfur compounds in the exhaust comes from the difficulty of measurement. Emissions of UHCs, which are a liquid or solid at room temperature, are very low and only make a minor contribution to the exhaust particulate loading.

Water/Steam Injection Hardware

The injection of water or steam into the combustion cover/fuel nozzle area has been the primary method of NO_x reduction and control in GE heavy-duty gas turbines since the early 1970s. The same design gas turbine equipment

is supplied for conversion retrofits to existing gas turbines for either injection method. Both NO_x control injection methods require a micro-processor controller, therefore turbines with older controls need to have their control system upgraded to Mark V or Mark VI SPEEDTRONIC™ controls conversion. The control system for both NO_x control injection methods utilizes the standard GE gas turbine control philosophy of two separate independent methods for shutting off the injection flow.

The NO_x water injection system is shown schematically in *Figure 31* and consists of a water pump and filter, water flowmeters, water stop and flow control valves. This material is supplied on a skid approximately 10 x 20 feet in size for mounting at the turbine site. The water from the skid is piped to the turbine base where it is manifold to each of the fuel nozzles using pigtails. The water injection at the combustion chamber is through passages in the fuel nozzle assembly. A typical water injection fuel nozzle assembly is shown schematically in *Figure 32*. For this nozzle design there are eight or twelve

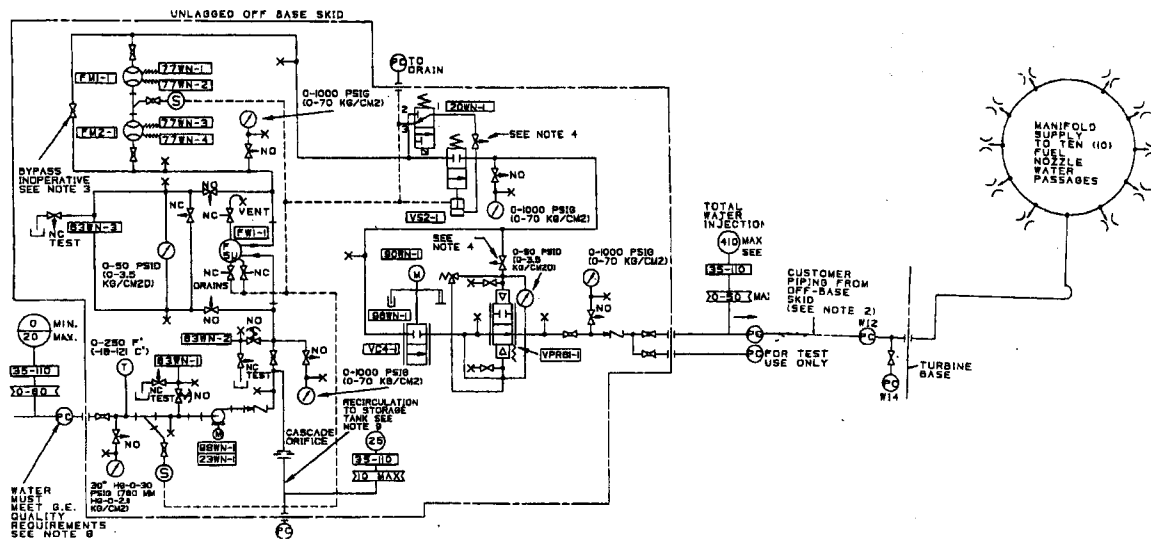

Figure 31. Schematic piping – water injection system

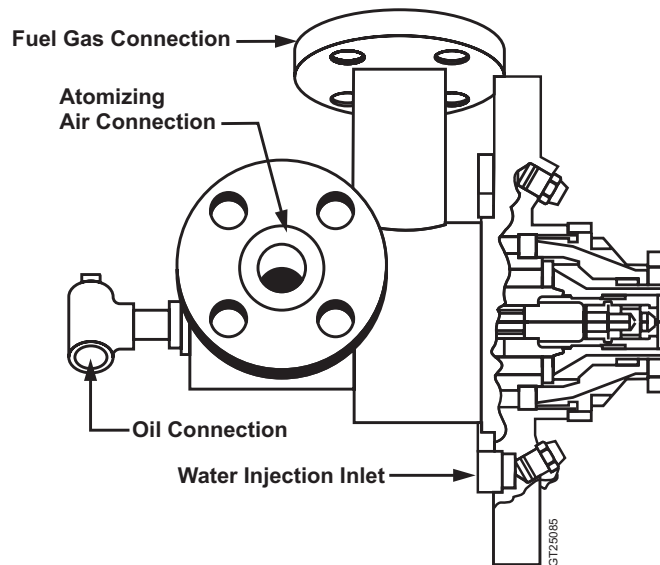

Figure 32. Water injection fuel nozzle assembly

water spray nozzles directing the water injection spray towards the fuel nozzle tip swirler. While this design is quite effective in controlling the NO_x emissions, the water spray has a tendency to impinge on the nozzle tip swirler and on the liner cap/cowl assembly. Resulting thermal strain usually leads to cracks, which limits the combustion inspections to 8000 hours or less. To eliminate this cracking, the latest design water-injected fuel nozzle is the breech-load fuel nozzle. (See *Figure 33*.) In this design the water is injected through a central fuel nozzle passage, injecting the water flow directly into the combustor flame. Since the water injection spray does not impinge on the fuel nozzle swirler or the combustion cowl assembly, the breech load fuel nozzle design results in lower maintenance and longer combustion inspection intervals for NO_x water injection applications.

The NO_x steam injection system is shown schematically in *Figure 34*, and consists of a steam flowmeter, steam control valve, steam

stop valve, and steam blowdown valves. This material is supplied loose for mounting near the turbine base by the customer. The steam-injection flow goes to the steam-injection manifold on the turbine base. Flexible pigtailed are used to connect from the steam manifold to each combustion chamber. The steam injection into the combustion chamber is through machined passages in the combustion can cover. A typical steam-injection combustion cover with the machined steam-injection passage and steam injection nozzles is shown in *Figure 35*.

Water quality is of concern when injecting water or steam into the gas turbine due to potential problems with hot gas path corrosion, and effects to the injection control equipment. The injected water or steam must be clean and free of impurities and solids. The general requirements of the injected water or steam quality are shown in *Table 6*. Total impurities into the gas turbine are a total of the ambient air, fuel, and injected water or steam. The total impurities

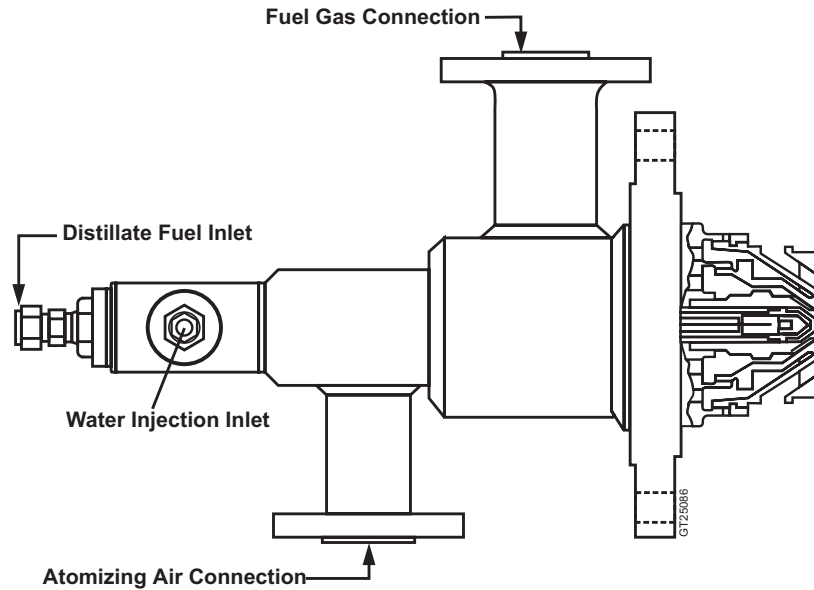

Figure 33. Breech-load fuel nozzle assembly

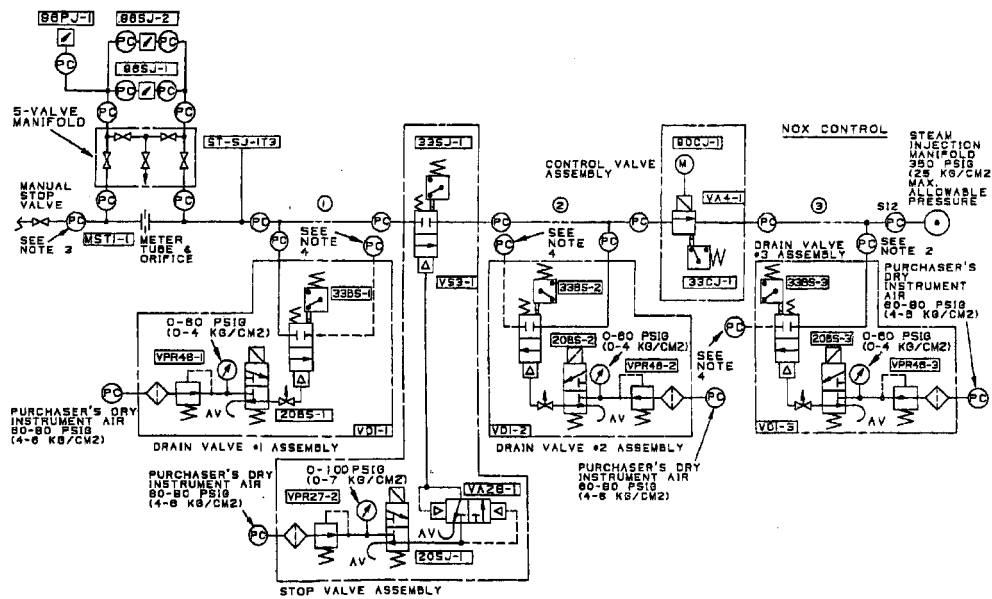
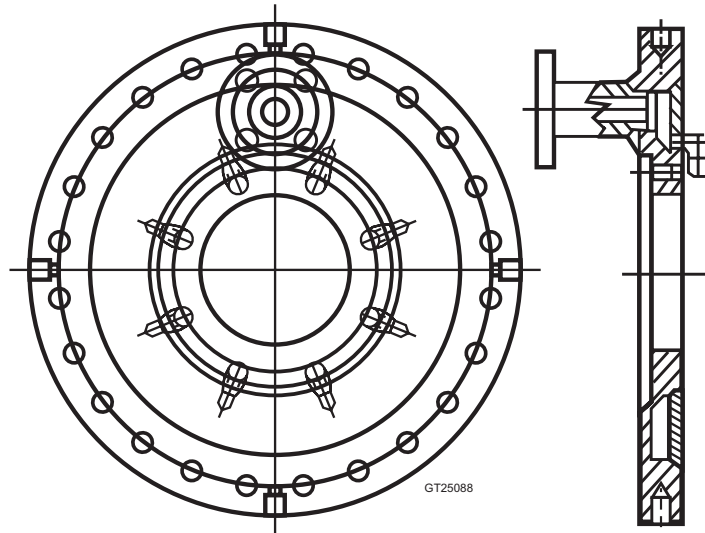

Figure 34. Schematic piping – steam injection system

requirement may lower the water or steam-injection quality requirements. It is important to note that the total impurities requirement is provided relative to the input fuel flow.

Minimum NO_x Levels

As described above, the methods used to reduce thermal NO_x inside the gas turbine are by combustor design or by diluent injection. To see



NOTE: This drawing is not to be used for Guarantees

Figure 35. Combustion cover – steam injection

<ul style="list-style-type: none"> WATER/STEAM QUALITY Total Dissolved Solids Total Trace Metals (Sodium + Potassium + Vanadium + Lead) pH NOTE: Quality requirements can generally be satisfied by demineralized water. 	<p>5.0 ppm Max. 0.5 ppm Max. 6.5 – 7.5</p>										
<ul style="list-style-type: none"> TOTAL LIMITS IN ALL SOURCES (Fuel, Steam, Water, Air) <table border="0" style="width: 100%;"> <thead> <tr> <th style="text-align: left;">Contaminant</th> <th style="text-align: right;">Max. Equivalent Concentration (ppm – wt)</th> </tr> </thead> <tbody> <tr> <td>Sodium + Potassium</td> <td style="text-align: right;">1.0</td> </tr> <tr> <td>Lead</td> <td style="text-align: right;">1.0</td> </tr> <tr> <td>Vanadium</td> <td style="text-align: right;">0.5</td> </tr> <tr> <td>Calcium</td> <td style="text-align: right;">2.0</td> </tr> </tbody> </table> 	Contaminant	Max. Equivalent Concentration (ppm – wt)	Sodium + Potassium	1.0	Lead	1.0	Vanadium	0.5	Calcium	2.0	
Contaminant	Max. Equivalent Concentration (ppm – wt)										
Sodium + Potassium	1.0										
Lead	1.0										
Vanadium	0.5										
Calcium	2.0										

Table 6. Water or steam injection quality requirements

Gas Turbine Emissions and Control

NO_x emissions from each frame size without any control, refer to *Table 3*. With the LHE liner design, dry (no water/steam injection) NO_x emissions could be reduced by 15–40% relative to standard liner. This is the limit of LHE liner technology.

With water or steam injection, significant reduction in NO_x is achieved. The lowest achievable NO_x values with water/steam injection from GE heavy-duty gas turbines are also shown in *Table 3*. The table provides the current minimum NO_x levels for both methane natural gas fuel and #2 distillate fuel oil.

Maintenance Effects

As described previously, the methods used to control gas turbine exhaust emissions have an effect on the gas turbine maintenance intervals. *Table 7* provides the recommended combustion inspection intervals for current design Advanced Technology combustion systems used in base load continuous duty gas turbines without NO_x control systems and the recommended combustion inspection intervals with the vari-

ous NO_x control methods at the NO_x ppmvd @ 15% O₂ levels shown. Both natural gas fuel and #2 distillate fuel recommended combustion inspection intervals are included. Review of *Table 7* shows that the increased combustion dynamics (as the combustor design goes from dry to steam injection) and then to water injection results in reductions in the recommended combustion inspection intervals.

Performance Effects

As mentioned previously the control of NO_x can impact turbine firing temperature and result in gas turbine output changes. Additionally, the injection of water or steam also impacts gas turbine output, heat rate, and exhaust temperature. *Figure 36* shows the impact of NO_x injection on these gas turbine parameters when operating at base load for all single shaft design gas turbines. Note that the injection rate is shown as a percentage of the gas turbine compressor inlet airflow on a weight basis. The output and heat rate change is shown on a percent basis while exhaust temperature is

		Natural Gas/ No. 2 Distillate ppmvd @ 15% O ₂	Natural Gas Fired Hours of Operation Water/Steam Injection	No. 2 Distillate Fired Hours of Operation Water/Steam Injection
MS5001P N/T	Dry NSPS	142/211	12,000/12,000	12,000/12,000
		87/86	12,000/12,000	6,000/6,000
		42/65	6,000/6,000	6,000/6,000
		42/42	6,000/6,000	1,500/4,000
MS6001B	Dry NSPS	148/267	12,000/12,000	12,000/12,000
		94/95	8,000/8,000	6,000/6,000
		42/65	8,000/8,000	8,000/8,000
		42/42	8,000/8,000	4,000/4,000
MS7001E	Dry NSPS	154/228	8,000/8,000	8,000/8,000
		96/97	8,000/8,000	8,000/8,000
		42/65	6,500/8,000	6,500/8,000
		42/42	6,500/8,000	1,500/3,000
MS9001E	Dry	25/42	8,000/8,000	6,000/6,000
		147/220	8,000/8,000	8,000/8,000
		42/65	6,500/8,000	6,500/8,000

Inspection Intervals reflect current hardware. Older units with earlier vintage hardware will have lower Inspection intervals.
 The above values represent initial recommended combustion inspection intervals. The intervals are subject to change based on experience.
 Base Load Operation.
 NSPS NO_x levels are 75 ppm with heat rate correction included.

Table 7. Estimated ISO NO_x level effects on combustion inspection intervals

Gas Turbine Emissions and Control

shown in degrees F. Review of *Figure 36* shows that turbine output is increased when NO_x injection is used. The gas turbine load equipment must also be capable of this output increase or control changes must be made in order to reduce the gas turbine output.

Summary

The emissions characteristics of gas turbines have been presented both at base load and part load conditions. The interaction of emission control on other exhaust emissions as well as

the effects on gas turbine maintenance and performance have also been presented. The minimum controllable NO_x levels using LHE and water/steam injection techniques have also been presented. Using this information, emissions estimates and the overall effect of the various emission control methods can be estimated.

It is not the intent of this paper to provide site-specific emissions. For these values, the customer must contact GE.

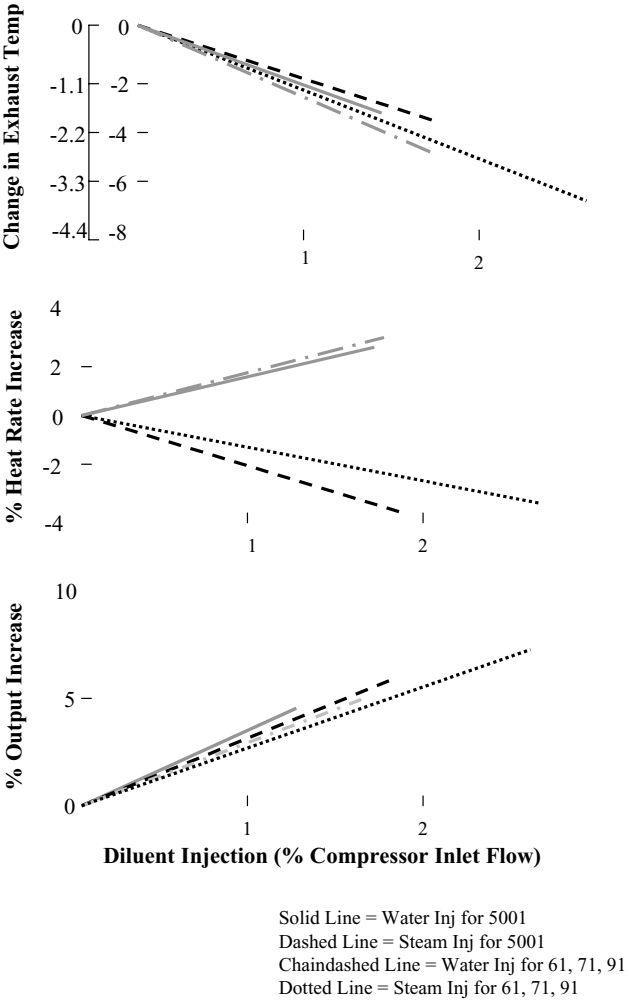

Figure 36. Performance effects vs. diluent injection

List of Figures

- Figure 1. MS7001EA NO_x emissions
- Figure 2. MS6001B NO_x emissions
- Figure 3. MS5001P A/T NO_x emissions
- Figure 4. MS5001R A/T NO_x emissions
- Figure 5. CO emissions for MS7001EA
- Figure 6. UHC emissions for MS7001EA
- Figure 7. Calculated sulfur oxide and sulfur emissions
- Figure 8. MS7001EA NO_x emissions
- Figure 9. MS6001B NO_x emissions
- Figure 10. MS5001P A/T NO_x emissions
- Figure 11. MS5001R A/T NO_x emissions
- Figure 12. Inlet guide vane effect on NO_x ppmvd @ 15% O₂ vs. load
- Figure 13. Inlet guide vane effect on NO_x lb/hour vs. load
- Figure 14. MS5001R A/T NO_x emissions vs. shaft speed
- Figure 15. MS3002J regenerative NO_x vs. load
- Figure 16. MS5002B A/T regenerative NO_x vs. load
- Figure 17. Ambient pressure effect on NO_x frame 5, 6 and 7
- Figure 18. Ambient temperature effect on NO_x frame 5, 6 and 7
- Figure 19. Relative humidity effect on NO_x frame 5, 6 and 7
- Figure 20. NO_x production rate
- Figure 21. Standard simple cycle MS5002 combustor liner
- Figure 22. Louvered low NO_x lean head end combustion liners
- Figure 23. Field test data: simple-cycle MS5002 NO_x
- Figure 24. Field test data: simple-cycle MS5002 CO
- Figure 25. Field test data: simple-cycle MS3002J with steam injection for power augmentation
- Figure 26. MS7001E NO_x reduction with water injection
- Figure 27. MS7001E combustor dynamic pressure activity
- Figure 28. Carbon monoxide vs. water injection effect of firing temperature – MS7001B
- Figure 29. CO emissions for MS7001EA
- Figure 30. UHC emissions for MS7001EA
- Figure 31. Schematic piping – water injection system
- Figure 32. Water injection fuel nozzle assembly
- Figure 33. Breech-load fuel nozzle assembly
- Figure 34. Schematic piping – steam injection system
- Figure 35. Combustion cover – steam injection
- Figure 36. Performance effects vs. diluent injection

List of Tables

- Table 1. Gas turbine exhaust emissions burning conventional fuels
- Table 2. Relative thermal NO_x emissions
- Table 3. NO_x emission levels at 15% O₂ (ppmvd)
- Table 4. Emission control techniques
- Table 5. Lean head end (LHE) liner development
- Table 6. Water or steam injection quality requirements
- Table 7. Estimated ISO NO_x level effects on combustion inspection intervals