

GE STEAM POWER

**The Power of Yes.**



[ge.com/power](https://www.ge.com/power)



## Converting nuclear energy into abundant, reliable and cost-effective electricity

Nuclear power plant operators around the world share a single goal – to produce sustainable and affordable energy, and to make it accessible to all. How well they deliver on this goal determines their future.

GE benefits from a 60-year heritage in nuclear turbine islands and 60 years of experience designing, and servicing nuclear power plants. We provide turbine island solutions for all reactor types that maximise power output, reduce environmental footprint and lower operational cost.

Our cost-competitive integrated turbine island solutions bring together project management and technology expertise. We will help deliver the solutions you need, on time and on budget.

Our turnkey turbine island offering includes the critical power generation equipment—from the turbine generator package, to the services, pumps and control systems. By designing, manufacturing, installing and maintaining nuclear plant power generation equipment, we can help you improve end-to-end efficiency.

We have developed an extensive worldwide network with engineering centers and manufacturing sites specialized in nuclear equipment. In addition, to strengthen our local presence, we have international joint ventures, partnerships and robust alliances with many leading reactor suppliers.

Half of the world's nuclear power plants use our steam turbine technology, providing more than 200 GW to the grid – enough to meet the electricity needs of 175 million households. With GE Steam Power, you'll have more than a technology provider. You will have a real partner, working with you from the conceptual stage of the power plant development through the full life of the equipment.

# TABLE OF CONTENTS

## Nuclear Energy Industry Overview

### Our Expertise

### Technology Leadership

### Turbine Island Solutions

### Turbine Generator Package Products

Steam Turbines

Generators

Controls

Heat Exchangers

### Feedwater Plant Package

### Heat Rejection System

© November 2019, General Electric Company. GE Proprietary Information - This document contains General Electric Company (GE) proprietary information. It is the property of GE and shall not be used, disclosed to others or reproduced without the express written consent of GE, including, but without limitation, in the creation, manufacture, development, or derivation of any repairs, modifications, spare parts, or configuration changes or to obtain government or regulatory approval to do so, if consent is given for reproduction in whole or in part, this notice and the notice set forth on each page of this document shall appear in any such reproduction in whole or in part. The information contained in this document may also be controlled by the US export control laws. Unauthorized export or re-export is prohibited. This presentation and the information herein are provided for information purposes only and are subject to change without notice. NO REPRESENTATION OR WARRANTY IS MADE OR IMPLIED AS TO ITS COMPLETENESS, ACCURACY, OR FITNESS FOR ANY PARTICULAR PURPOSE. All relative statements are with respect to GE technology unless otherwise noted.

# NUCLEAR ENERGY INDUSTRY OVERVIEW

Nuclear power plants deliver dependable, continuous, **largescale, round-the-clock electricity** for many months at a time, without interruption. These plants are primarily used to provide baseload power and are capable of load-follow operation to help ensure a **stable grid** when intermittent energies are part of the supply mix.

Nuclear power is the only large scale dependable energy source producing no CO<sub>2</sub> or other greenhouse gases, thus **fully contributing to mitigation of climate change**.

- At the end of 2018, more than **456 commercial nuclear power reactors (>400 GW)** will be in operation and will provide about **12 percent of the world's electricity**.
- More than 140 GW of new capacity are foreseen by 2025.
- Fifty-three percent of the global demand will come from China.

## Nuclear Industry Drivers

- Dependable energy solutions
- Predictable and low cost of electricity
- Availability and grid stability
- Low emissions

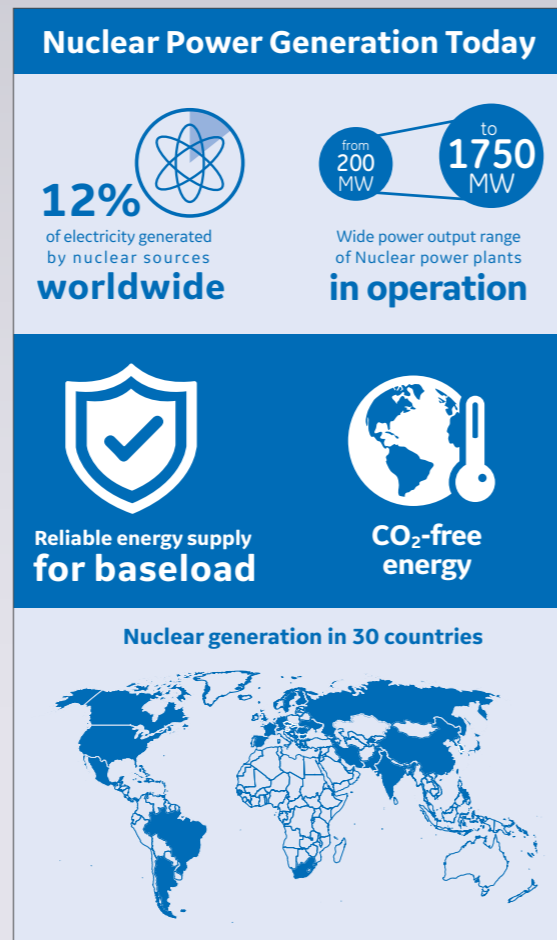

# NUCLEAR POWER CONVERSION

## Our Expertise

Committed to helping customers **lower their generation costs** and **maximise higher revenue**, GE has designed and manufactured efficient and competitive turbine islands up to 1,750 MW. With GE, customers have a proven turbine island solution that can align with a chosen reactor and site conditions to maximize power output.

## Turnkey Turbine Island

**With more than 200 GW of integrated solutions installed worldwide**, GE has the expertise and experience to **simplify the management and execution of large-scale projects** and plant construction for power plant operators.

## Predictable Life Cycle Costs

In addition to improved efficiency, today's power producers demand lower maintenance costs and high reliability. GE components are designed for excellent reliability and maintainability, with the ARABELLE\* turbine achieving a **99.96% reliability rate**.

## A Solution for Any Grid

At GE, we understand the need for a flexible baseload. **Grid stability and energy security** are growing concerns worldwide, particularly with the introduction of intermittent resources in the energy mix.

Our turbine island typical load follow mode for a 1,700 MWe unit compensates for the starting or de-venting of 30 large wind turbines every minute (i.e., 85 MWe/min).

**The International Energy Agency (IEA) and the Nuclear Energy Agency (NEA) called for an increased contribution of nuclear energy to achieve a scenario in which long-term global temperature increases are limited to 2°C (2D Scenario).**

## Selected Excerpts from the Technology Roadmap, Nuclear Energy

*"Nuclear power is the largest source of low-carbon electricity in OECD countries."*

*"In the 2D scenario, global installed capacity would need to more than double from current levels of 396 GW to reach 930 GW in 2050, [...] a formidable growth for the nuclear industry."*

*"Annual connection rates should increase from 5 GW in 2014 to well over 20 GW during the coming decade."*

*"The contributions of nuclear energy – providing valuable baseload electricity, supplying important ancillary services to the grid and contributing to the security of energy supply – must be fully acknowledged."*

# NUCLEAR POWER GENERATION

## Our Experience

Since the birth of nuclear power generation more than 60 years ago, GE and Alstom have supported nuclear power plant operators. Today, GE **steam turbine technology operates in 50 percent of the world's nuclear plants** with a capacity of more than **200 GW for the global grid**.

### A Heritage of 100 Years of Leadership in Steam Turbines and 60 Years of Experience in Nuclear

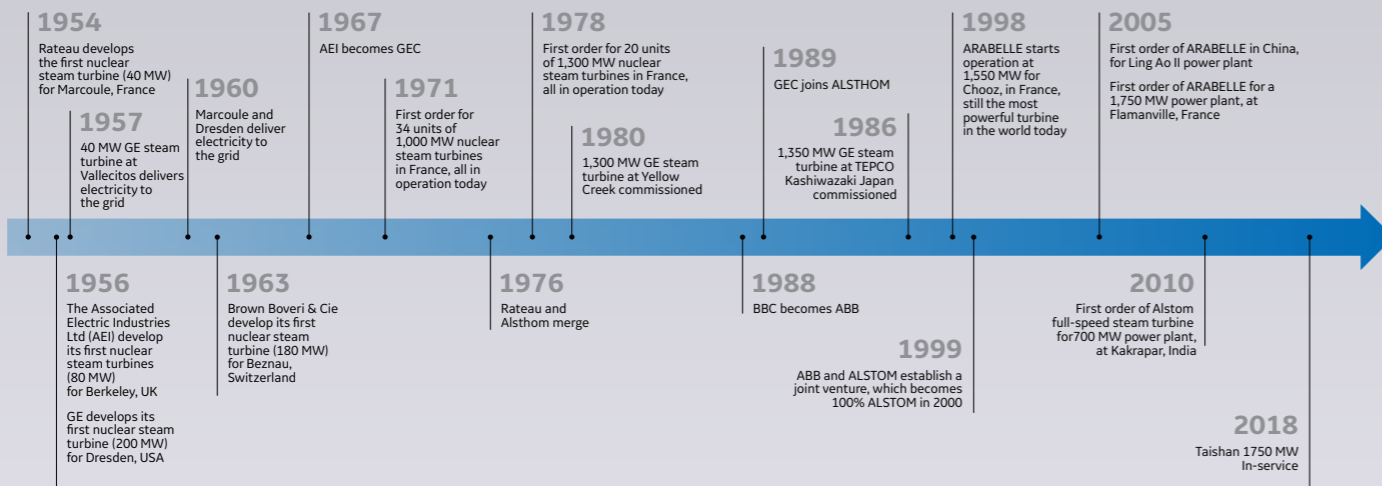

Since the first nuclear power plants, GE has been steadily developing the industry, in depth and breadth

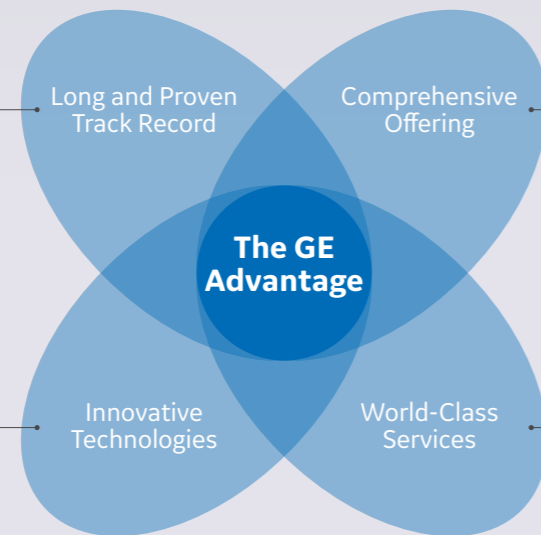

GE offers all main equipment and integration engineering of the turbine island for any nuclear reactor

GE engineers have been investigating many industries and continue to set the benchmark for power conversion systems

GE has the global capability to enhance the performance and reliability of your machines

### A Global Leader with Local Expertise

With a deep understanding of both global power markets and local requirements, GE is well equipped to answer today's energy challenges and build long-term relationships with our customers.

With partnerships in China, Russia and India, as well as manufacturing capabilities in three continents, we have built a strong community of people and companies dedicated to bringing the best nuclear power conversion technology to our customers.





# NUCLEAR POWER CONVERSION

## Technology Leadership

### Research and Development – Revolutionary and Evolutionary

With more than 100 years of experience in engineering, procurement, and construction of new power plants, GE is constantly innovating when it comes to technology, products, project execution and maintenance.

GE’s approach consists of monitoring and investigating revolutionary techniques while **implementing evolutionary changes**. This helps us anticipate technological breakthroughs and progressively improve products, **protecting customer investment and decreasing risk**.

Recent improvements across the major technology disciplines:

Disciplines	Advantages	Benefits
<b>Advanced Aero</b>	<ul style="list-style-type: none"> <li>Blade 3D modeling</li> <li>Variable reaction ratio</li> <li>Reduced secondary losses</li> <li>75-inch last stage blades for top efficiency</li> </ul>	Continuously increasing the steam turbine expansion <b>efficiency</b> and limiting the entropy rise provide <b>more MW</b> and, ultimately, a <b>lower cost of electricity</b> .
<b>Fluid Dynamics</b>	<ul style="list-style-type: none"> <li>Turbine diffuser and condenser neck 3D modeling</li> <li>Parametric design of pumps’ discharge volutes</li> </ul>	Improved fluid dynamics studies on steam turbine, heat exchangers, and pumps are key to improving the <b>cycle efficiency</b> and reducing the <b>cost of electricity</b> .
<b>Moisture Separation</b>	<ul style="list-style-type: none"> <li>Improved calculation of biphasic flows to limit the amount of model tests required</li> <li>Cutting-edge, chevron design of moisture separator</li> <li>Efficient water traps for superior water separation</li> </ul>	Water removal, whether inside the steam turbine or in the moisture separator, helps improve both <b>efficiency</b> and reliability of the steam turbine, providing <b>more MW</b> and MWh to the customer.
<b>Digital Control</b>	<ul style="list-style-type: none"> <li>Smart and simple operation</li> <li>Smart instrumentation</li> <li>Diagnostic and predictive maintenance</li> <li>Improved customer experience</li> </ul>	Artificial intelligence enables automatic response to transients, and <b>improvement of grid ancillary services</b> . Accurate use of operation feedback in simulators allows maintenance teams to perform <b>predictive maintenance</b> . Improved digital control helps increase plant <b>operational flexibility and reduce outage times</b> .
<b>Advanced Construction Methods</b>	<ul style="list-style-type: none"> <li>Construction lead time reduction, smart construction sequences, and planning securitization</li> <li>Reasoned modularization to delocalize activity from site</li> </ul>	Nuclear power plant construction combines technical complexity, physically large equipment, and a large number of components. Modern construction methods, such as modularization, integrated 4D models, and clever interface management can help <b>reduce overall construction time, associated risks, and project costs</b> .

This track record for continuous innovation over a prolonged period, combined with an **uninterrupted array of projects**, has allowed GE to become an **industry leader in nuclear power generation systems**.

### Our Continuous Flow of Global Projects Over the Last 30 Years

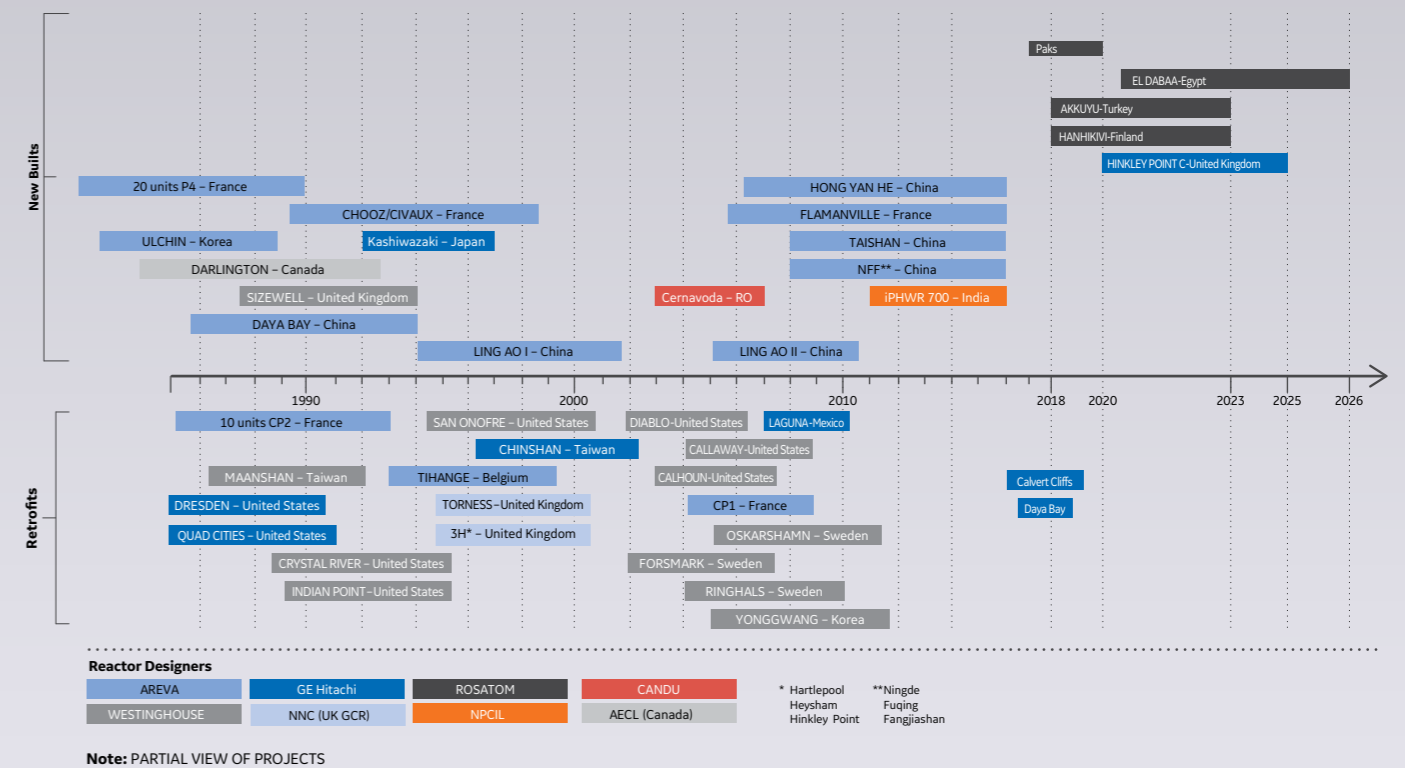

## Reliable nuclear turbine island solutions for all reactor types

# TURBINE ISLAND SOLUTIONS

## Total Life Cycle Approach

From initial design to life cycle services, GE manages the nuclear power conversion value chain to bring **advantages to our customers**. Through our close working relationships, we understand customer needs and requirements, and that knowledge shapes our product development and enhancements.

### 1 Research and Development

Through our **extensive operating fleet and maintenance activities**, GE receives a steady stream of comprehensive feedback from nuclear power plant operators. Our internal teams use this data to **continuously improve product design and full system integration**.

### 2 Design and Project Development

To increase the return on investment from a new plant, GE's engineering teams assess heat sink conditions, site location, and customer requirements to **define plant configuration and improve power output**.

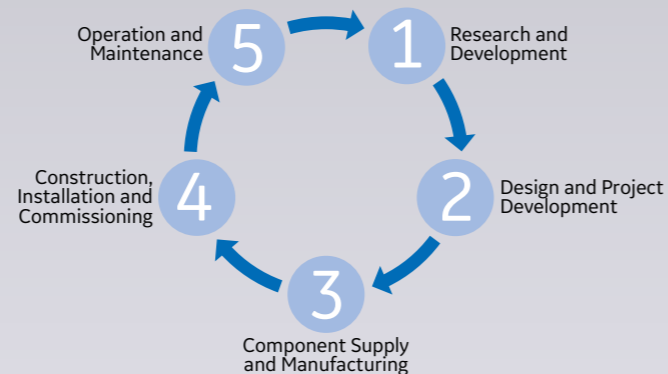

### 3 Component Supply and Manufacturing

GE is an **original equipment manufacturer (OEM) that offers a full portfolio of turbine island components** suited to **all reactor types**.

All of GE's worldwide manufacturing facilities work to the same **quality standards**, delivering advanced products to customers from a local base. The facilities are all certified to:

- International Standard Organization (ISO) 9001 Quality System Standard
- ISO 14001 Environmental Management

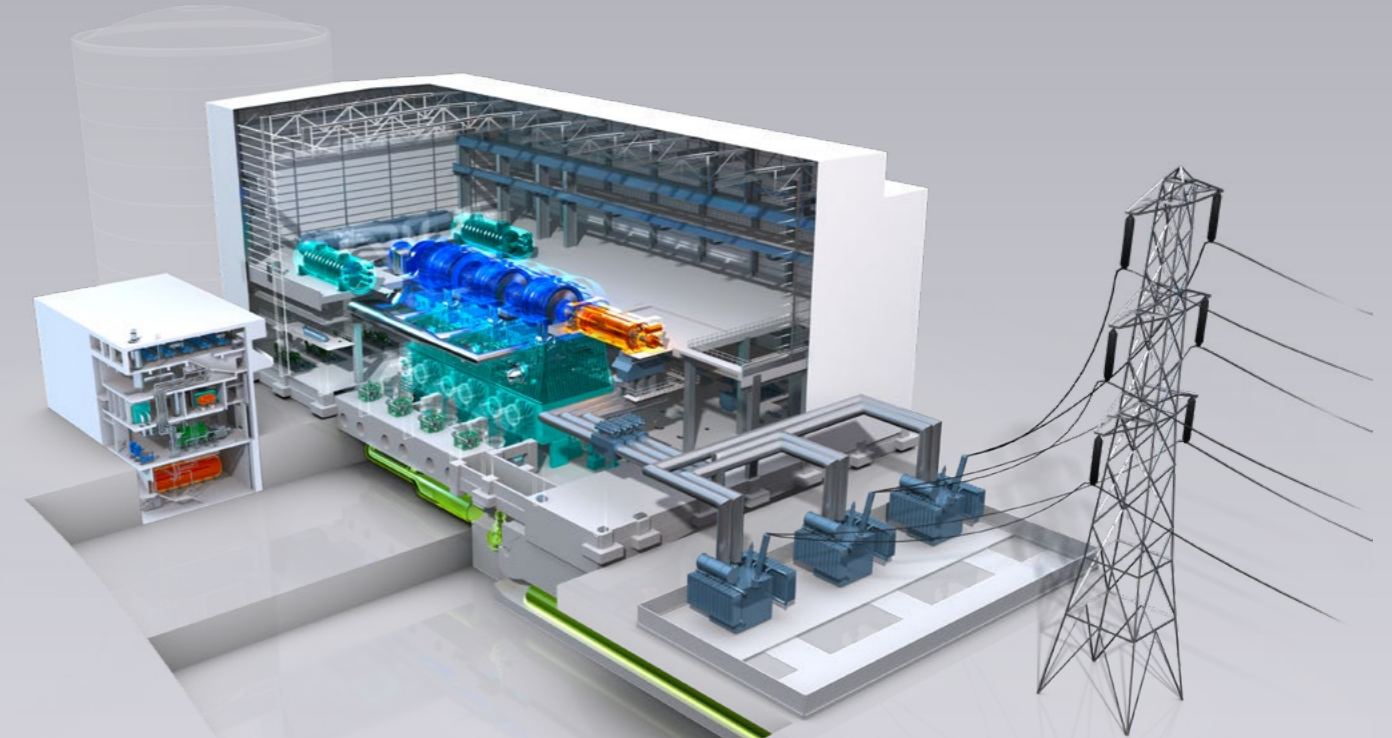

- Largest operating fleet
- OEM with full turbine island portfolio for all reactors
- Leading reliability, power output and efficiency

### 4 Construction, Installation, and Commissioning

Working closely with civil works and mechanical construction contractors, we have developed **modern construction techniques and tools**, including modularization, open-top construction, and smart installation sequences, to **decrease coactivity and improve interface management**.

### 5 Operation and Maintenance

GE maintains, upgrades, retrofits, and repairs all components and systems, **including those provided by other suppliers**. GE covers the entire turbine island with a comprehensive portfolio of services:

- Parts
- Repairs
- Field service
- Advice and operational support
- Performance improvements and retrofit engineering
- Compliance-related support services
- Service contracts
- Services on other original equipment manufacturers

# TURBINE ISLAND SOLUTIONS

## A Leader in Turbine Island Integration

GE has extensive expertise in the management of **large-scale nuclear power conversion projects**, from early identification to commercial operation.

GE supports customers from the earliest stages of development:

- Capturing the plant’s mission and goals
- Increasing power plant output to get the most from the selected reactor and site
- Answering grid requirements
- Providing safety analysis reports for national authorities

In pre-engineering phases, local regulations and standards are taken into consideration when adapting reference designs.

Requirement management is put in place to help ensure the **technical documentation** (interface management, manufacturing, procurement, logistics, installation, and commissioning) **is updated during the project life** and includes any design changes.

Comprehensive project detail is maintained with **accurate interface data**. All engineering disciplines, including civil, arrangement and piping, process, mechanical and electrical, have current, **real-time access to the same 3D model**.

A **reliable construction program** is important to the development of a nuclear power plant project. Working with 4D scheduling programs and linking to a 3D model of the turbine island with a project timeline, GE **optimizes our open-top construction sequences and site crane strategy** for effective management of on-site activities. In addition to these programs, **innovative modularization techniques** and smart modules can be implemented for a **fast and safe construction program**.

These modules reduce on-site assembly and workforce requirements, improving quality and EHS compliance.

## Flexible Offerings

Whether a customer requires a **turnkey turbine island or a single component**, GE can provide a fully customized combination of engineering and equipment.

As an original equipment manufacturer of all key components in a nuclear power conversion system, GE can provide **integration competencies** for the turbine island, from conceptual design to a full turnkey solutions.

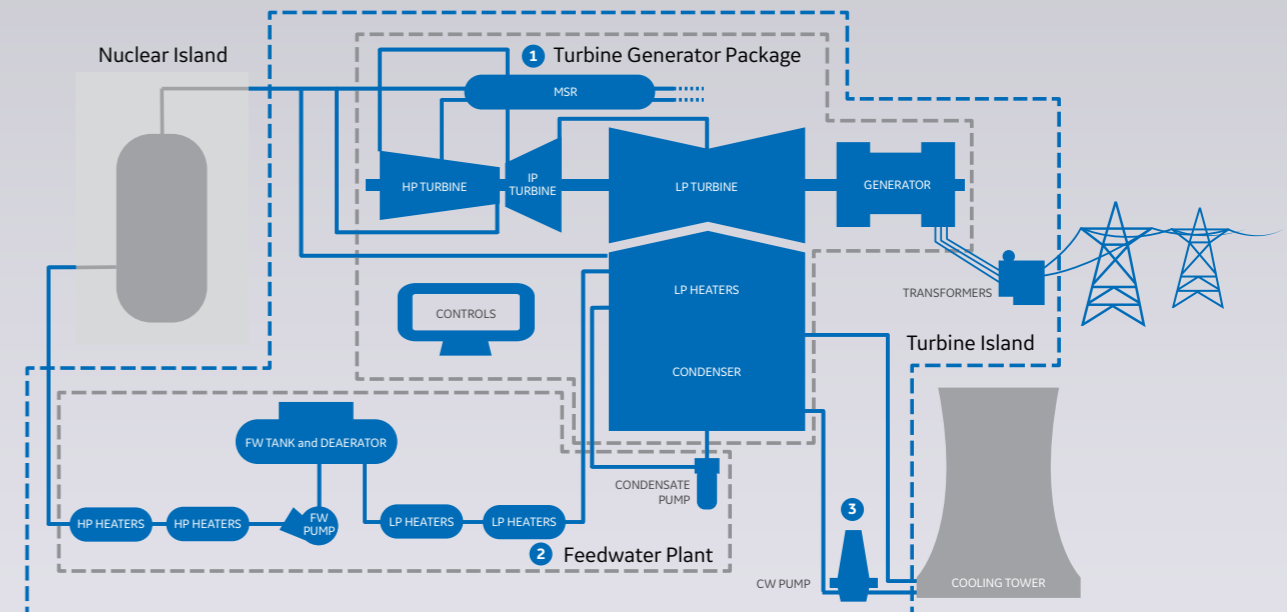

The turbine island can be segmented into **four major systems**. GE’s power generation offerings—steam turbines, generators, heat exchangers, pumps, and controls—are at the heart of each system.

<p><b>1 Turbine Generator Package</b></p> <p>Includes the steam turbine and its auxiliary equipment, the generator and its auxiliary equipment, the moisture separator reheater, the condenser, and the shaft line control system.</p>	<p><b>3 The Heat Rejection System</b></p> <p>Rejects heat to the environment, either once-through or with cooling towers. Includes main cooling water pumps.</p>
<p><b>2 The Feedwater Plant Package</b></p> <p>Reheats the condensate before it enters the nuclear steam supply system. Includes condensate pumps, heaters, feedwater tank, and feedwater pumps.</p>	<p><b>The Power Evacuation System</b></p> <p>Exports power to the grid. Includes circuit breakers, transformers and switchgear.</p>

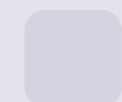
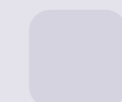



Turbine Generator Package

# GENERATOR HEALTH MONITORING

## Highest Level of Assurance

GE's remote **Generator Health Monitoring** provides a comprehensive service to any operator to assess the health of the generator by supplying key information for condition-based maintenance and to help prevent unplanned downtime and losses.

For the **highest level of assurance**, opt for remote continuous online monitoring and benefit from **weekly checks** and in-depth reports from our experts.

GE's Generator Health Monitoring provides the following benefits:

- Early fault identification
- Extended outage intervals
- Fewer unplanned outages
- More accurate planning and execution of outage work

### Outage Applicability

Generator Closed - Visual	Generator Open Rotor In - Minor	Generator Open Rotor Out - Major
✓	✓	✓

### Technical Data

Available Modules
Partial Discharge
Rotor Flux
Rotor Shaft Voltage
End Winding Vibration
<b>Stand-alone Boxes</b>
Collector Health Monitor
Stator Leakage Monitoring System

**Can GE help customers improve their maintenance profile by turning generator operating data into actionable knowledge?**

**YES.**

Generator Health Monitoring drives model-based condition monitoring helping customers understand pending issues before they become production issues, allowing proactive actions to avoid unplanned outages.

GHM saved a generator rotor from running into a fail state at one of our nuclear customer site, saving £100k of repair costs and securing availability, thus electricity production.

GE customers can now be armed with a suite of modules to continuously and confidently monitor the most critical areas of generators, allowing better control of capital expenditure and eventually insurance cost reduction.

**Can the most powerful GIGATOP 4-pole generators supply the Chinese power grid with up to 24 TWh of CO2-free electricity a year?**

**YES.**

In December 2018, for the first time ever, a 1755MW GIGATOP 4-pole generator entered into operation, enabling the generation of reliable and affordable electricity to more than 2 million Chinese homes.

Two 1755MW GIGATOP 4-pole generators will be operating in the Taishan Nuclear Power Plant. The manufacturing of the most powerful generators capitalised on more than 40 years of European experience in designing, manufacturing and commissioning generators for nuclear applications.

GE GIGATOP 4-pole generators is the technology of choice for nuclear islands, either for new steam turbine packages or for the replacement of OEM and other OEM 4-pole generators in existing turbine islands.

**This is the Power of Yes.**





Turbine Generator Package

# STEAM TURBINE PRODUCT PORTFOLIO

Flexible Portfolio Serving All Reactor Types

GE is the **leading supplier of steam turbines** for the nuclear industry. Today, with our Alstom heritage, **50 percent of all nuclear power plants** in the world operate with GE's steam turbine technology inside. The steam turbine platform can cover all commercial reactor type or site conditions, producing unit output ranging from **50 MWe to 1,900 MWe**, in both 50 Hz and 60 Hz countries.

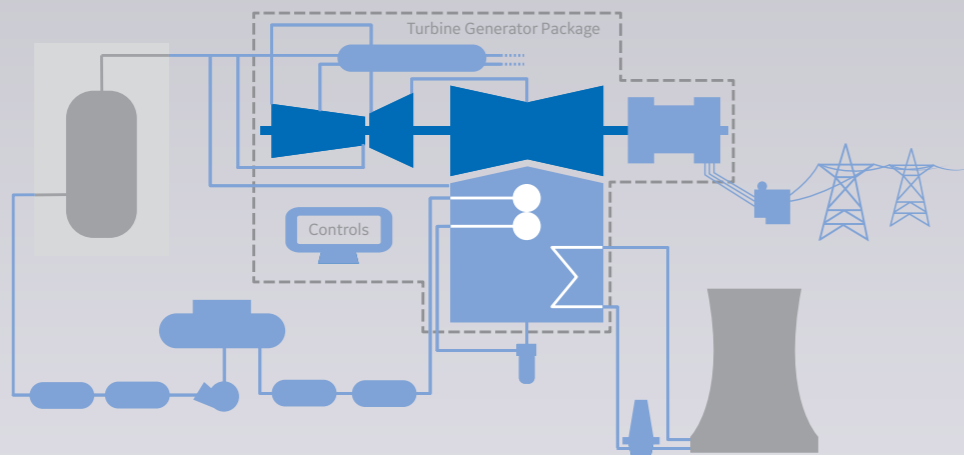

This steam turbine portfolio for the nuclear industry represents **60 years of continuous development**, manufacturing, operation, maintenance, and feedback from operators—all with a **focus on innovation**. Today, we continue to invest significantly in research and development to provide our customers with **proven technologies and solutions** that benefit them.

The steam flow delivered by the nuclear steam supply system (NSSS) participates in the selection of the high-pressure module, and the **fully adaptable steam path** will be tailored to match the steam requirements. The backpressure conditions will determine the necessary low pressure exhaust surface.

Our steam turbines benefit from continuous innovation to achieve a **low cost of electricity** through:

- Increased power output
- Higher reliability and reduced maintenance time
- Cost competitiveness and shorter delivery and installation times
- Improved operational flexibility to match most demanding grid requirements

The steam turbine portfolio for the **nuclear industry** covers the **full range of steam and water interface conditions and backpressure conditions**.

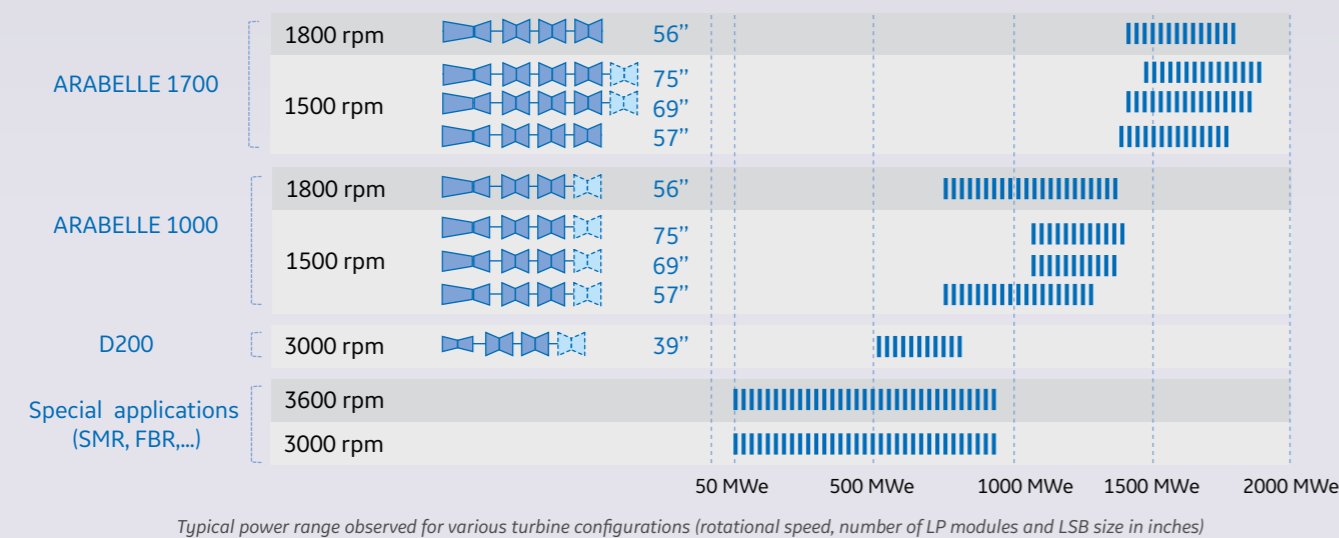

## Our turbine technology is inside 50 percent of all nuclear power plants worldwide

With our extensive steam turbine experience with nuclear, combined cycle, coal, and thermal renewables, we are able to deliver **advanced designs** for specific product development fitting all reactor technologies.

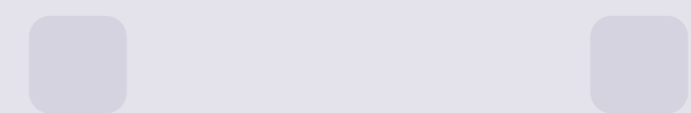

Turbine Generator Package

# STEAM TURBINE: ARABELLE PLATFORM

## Advanced and Innovative Steam Turbine Technology

The GE nuclear power conversion solutions for large and very large reactors are based on our ARABELLE steam turbine technology platform. The ARABELLE steam turbine can accommodate power outputs ranging from **700 MW to 1,900 MW**. The largest turbines in operation worldwide for the past 20 years are ARABELLE steam turbines with a 1,750 MW power output.

With the **unique architecture** of the ARABELLE turbine, the steam first expands in a single-flow high pressure (HP) path. After moisture separation and reheat, it then expands in a single-flow intermediate pressure (IP) section before going through the four, six or eight low pressure (LP) flows.



## Key Benefits

### More MW

- A compact, powerful, efficient and reliable turbine
- 60 percent of the power comes from highly efficient single flow expansion
- A unique combined HP/IP module
- Standard interface/footprint for 50 Hz and 60 Hz

### Adapted to All Reactor Types

- Fully adaptable steam path
- From 700 MW to 1,900 MW, 50 Hz or 60 Hz
- For any backpressure conditions
- Well fitted for co-generation applications such as district heating or desalination processes

### Welded Rotors for Reliability and Shorter Delivery Time

- High resistance to stress corrosion cracking (SCC)
- Fewer inspections required
- Smaller forgings for easier supply and inspection

### LP Size Configured for All Site Conditions

- A range of last-stage blade sizes for each frequency (50 Hz and 60 Hz)
- Proven blade design with demonstrated reliability
- Two, three or four LP modules for excellent back-pressure fit

### Designed for Ease of Maintenance

- Cross-under pipes below the foundation for reduced maintenance duration and costs
- Large lay-down areas alongside the LP modules
- Easier adjustment of LPs with independent structure
- Compact arrangement with fewer bladed rows

## Strong performance and reliability

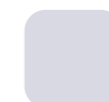
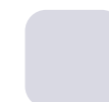



Turbine Generator Package

# STEAM TURBINE: ARABELLE PLATFORM

## LP Exhaust with Independent Structure

ARABELLE improves on the previous generation LP exhaust design with **fully independent LP cylinders**. By connecting the LP inner casing to an end wall rather than the LP outer casing and ultimately the turbine table, the outer casing no longer needs to act as support. This simple but powerful design innovation greatly **reduces turbine load on the foundation**, caused by vacuum variations or condenser forces while improving centering of both moving and stationary parts.

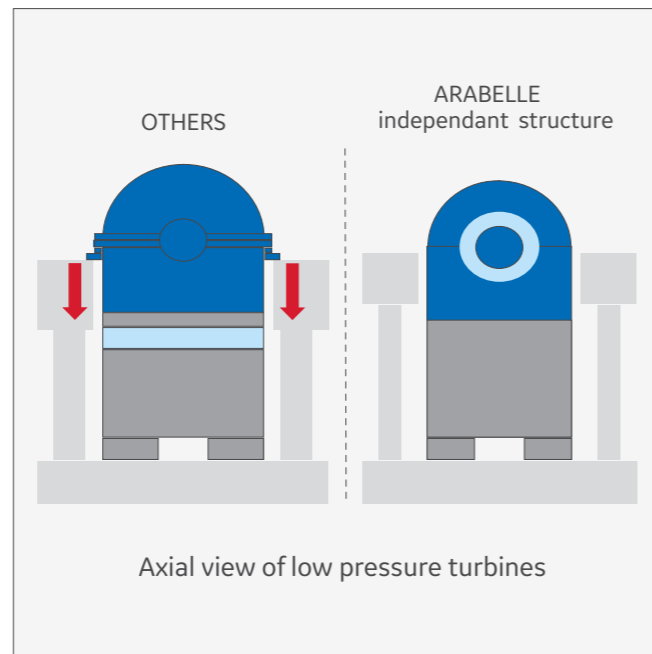

## Unique and proven design

## Efficient, Reliable Blading

The entire family of ARABELLE turbine blades features a three-dimensional profile engineered with high aerodynamic performance in mind. All rotating blades except the last stage blade (LSB) include integral shrouds to minimize loss. Manufacturing the blades as a unit eliminates loose parts. The resulting continuous blade structure helps ensure **reliable and consistently good frequency control**.

Detailed 3-D modeling precedes the manufacturing of the LSB. The models, which are subject to rigorous laboratory testing, take shape through a series of high-precision forgings. To provide **effective vibration control** during service, an **integral streamlined snubber** interconnects the LSBs.

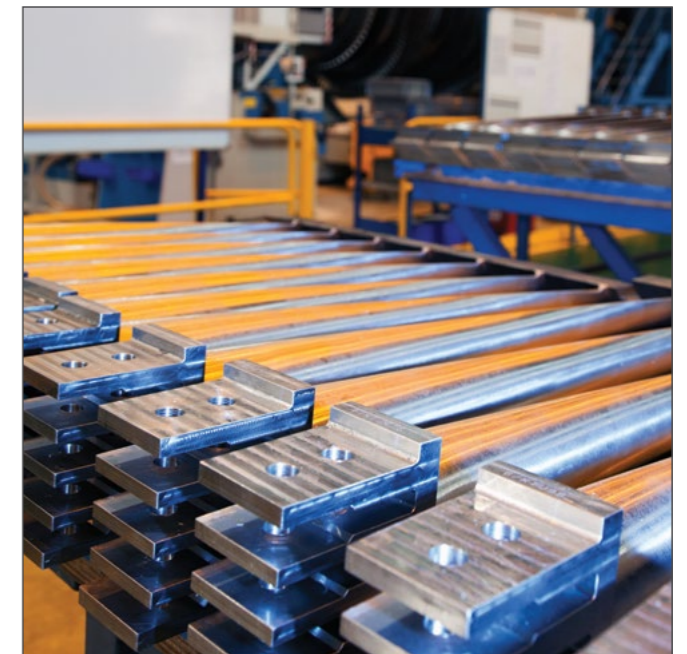

We count 224 rows of latest family of LSB blading in service with zero reliability findings.





Turbine Generator Package

# STEAM TURBINE: ARABELLE PLATFORM

	ARABELLE 1700	ARABELLE 1000
Typical Reactor Output	3500 – 4900 MWth	2500 – 3500 MWth
Shaft Line Rotational Speed	Half speed	Half speed
50 Hz		
HP/HIP Turbine Type	25NHIP17	25NHIP10
Number of LP Turbines	3 or 4	2 or 3
Last Stage Blade Length in inches (“)	57, 69, 75	57, 69, 75
60 Hz		
HP/HIP Turbine Type	30NHIP17	30NHIP10
Number of LP Turbines	3	2 or 3
Last Stage Blade Length in Inches (“)	56	56

	ARABELLE 1700	ARABELLE 1000
Reactor Type	EPR	CPR1000
Configuration	Combined HIP	Combined HIP
HP/HIP Turbine Type	25NHIP17	25NHIP10
Number of LP Turbines	3	2
LP Turbine Type	LP69	LP57
Frequency (Hz)	50	50
Speed (rpm)	1500	1500
Output (MWe)	1750	1080
Heaviest Lift – LP Rotor (tons)	280	190
Power Train Width (m)	20	17
Hook Height (m)	15	14.5
Power Train Length including Generator (m)	70	56





Turbine Generator Package

# STEAM TURBINE: D200 PLATFORM

## Long Track Record of Performance and Reliability for Medium-size Nuclear Reactors

The D200 turbine offers a **robust architecture** in which the steam first expands in a double-flow HP path. After moisture separation and reheat, it then expands in four or six LP flows. The turbine rotors, all of monoblock construction, are rigidly coupled to each other and to the generator rotor. Each rotor is supported by a pair of journal bearings.

Rightful heir of the most powerful 3,000 rpm turbines with saturated steam in operation in UK and China (**with more than 770,000 hours of operation**), the HP model uses high efficiency blading and features six stages to **increase both global efficiency and final power output**. HP steam exhausts are connected to the moisture separator reheater (MSR) by four **cross-under pipes**. This design for maintenance feature allows **servicing of the turbine without disassembling the exhaust pipes**.

The D200 turbine design is:

- **A compact solution** for medium-size reactors. Full-speed technology offers easy maintenance
- **A powerful, efficient turbine**, including cutting-edge blading technology. Adapted to any backpressure conditions, the D200 turbine can feature two or three LP modules for enhanced vacuum fit

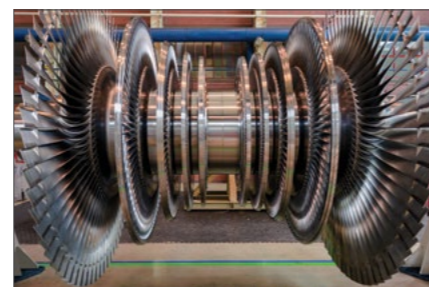

## Powerful, reliable and efficient

	D200
Typical Reactor Output	1500-2200 MWth
Shaft Line Rotational Speed (rpm)	3000
HP/HIP Turbine Type	50NH2F07
Number of LP Turbines	2 or 3
Last Stage Blade Length in Inches (")	39

	D200
Reactor Type	PHWR
Configuration	Double flow HP
HP/HIP Turbine Type	50NH2F07
Number of LP Turbines	3
LP Turbine Type	LP39
Frequency (Hz)	50
Speed (rpm)	3000
Output (MWe)	715
Heaviest Lift - LP Rotor (tons)	80
Power Train Width (m)	17
Hook Height (m)	15
Power Train Length incl. Generator (m)	53





Can GE supply  
my turbine  
island for  
my nuclear  
power plant?

YES.

GE will supply the two conventional turbine islands for Hinkley Point C, UK, which include the Arabelle steam turbine, generator, and other critical equipment. Already the biggest steam turbine in operation in China, HPC's **Arabelle turbines will be the largest ever built**—longer than an Airbus 380—and capable of producing **1,770 MW** each.

**This is the Power of Yes.**





# Turbine Generator Package

## GENERATORS

### Delivering Reliable Electrical Power

GE generators are reliable machines that offer high technical operating performance. These generators have demonstrated **successful operation** on more than **2,000 systems worldwide** and offer different power output levels and cooling mediums depending on customer needs. Their design contains features that lower plant investment cost while reducing operation and maintenance expenditures.

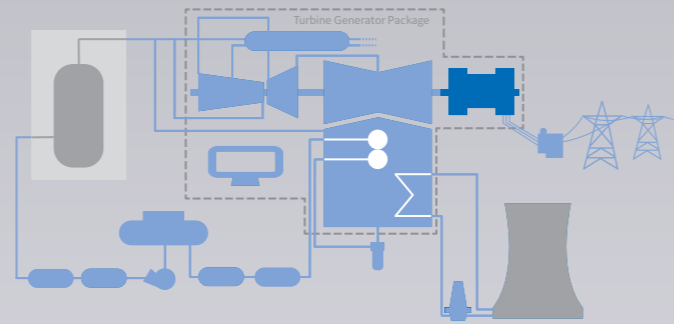

### Product Families

Product	Application	Rating
GIGATOP 4-pole generator, hydrogen-water-cooled	Nuclear half-speed applications (e.g. ARABELLE technology)	950 – 2,235 MVA
GIGATOP 2-pole generator, hydrogen-water-cooled	Nuclear full-speed applications (e.g. STN700 technology) and coal, oil, and gas power plants	510 – 1,400 MVA



## Lowering the cost of electricity

### Technologies that Bring Added Value

GE's proven approach to **continuous improvement** is backed by decades of experience. Our industry presence provides a wealth of **feedback from field operations**, which we apply to our technology development efforts for added customer value.

#### Stainless Steel for Stator-Winding Cooling

One common water-cooled generator problem is copper cooling tubes in the stator winding that become corroded and clogged. If untreated, this clogging can cause the stator bars to overheat and lead to a forced outage.

#### Self-Retightening End-Winding Support

During operation, the continuous mechanical stresses and thermal expansion that occur on conventional generator stator bars can loosen the stator end winding. This loosening degrades the insulation and can cause it to break down, resulting in a short circuit and forced outage.

#### Concave-Convex Wedges

The same forces that loosen the stator end winding on conventional generators also can induce loosening in the stator core, cause an insulation breakdown, and result in a forced outage.

### Additional Design Features Contribute to the High Performance and Low Maintenance Cost of GE's Generators:

- **Enhanced efficiency thanks to** Roebel bars in the stator winding, low-loss core laminations (reducing losses), and enhanced seal oil system (lower hydrogen losses)
- MICADUR\* insulation system for **higher reliability** with this proven insulation tape
- Enhanced stator core design for low losses, **shorter maintenance**, and high efficiency
- Enhanced cooling system to help with generator cooling and **higher technical performances**
- Skid-mounted auxiliaries that **save installation time** on site

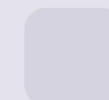
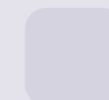

# Turbine Generator Package

## GIGATOP 4-POLE GENERATOR

Our GIGATOP 4-pole generator, based on technology from the Alstom heritage, has **90 units in operation worldwide** with **40 years of reliable experience**.

### Key Benefits:

- **Robust and reliable design.** The stator winding cooling tubes are made of stainless steel instead of copper, so there is no risk of corrosion and clogging from copper oxides
- **Powerful design.** Running at 1,550 MW at nuclear power plants in France, the GIGATOP 4-pole generator is also the world's most powerful generator in construction (1,755 MW).
- **Efficient and flexible,** with a cooling system that sustains a high level of efficiency
- **Easy to transport,** and ready for both rail and road
- **Easy maintenance,** as the inner parts of the machine are easily accessible

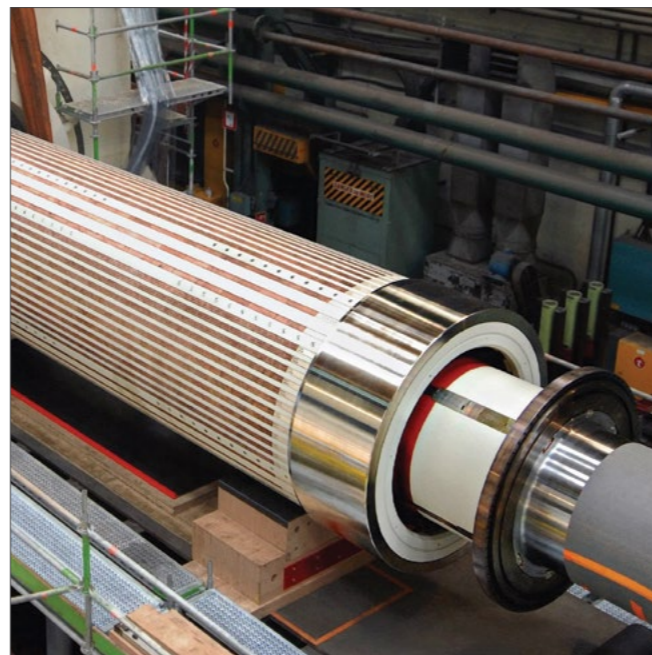

## World's largest generators in operation today

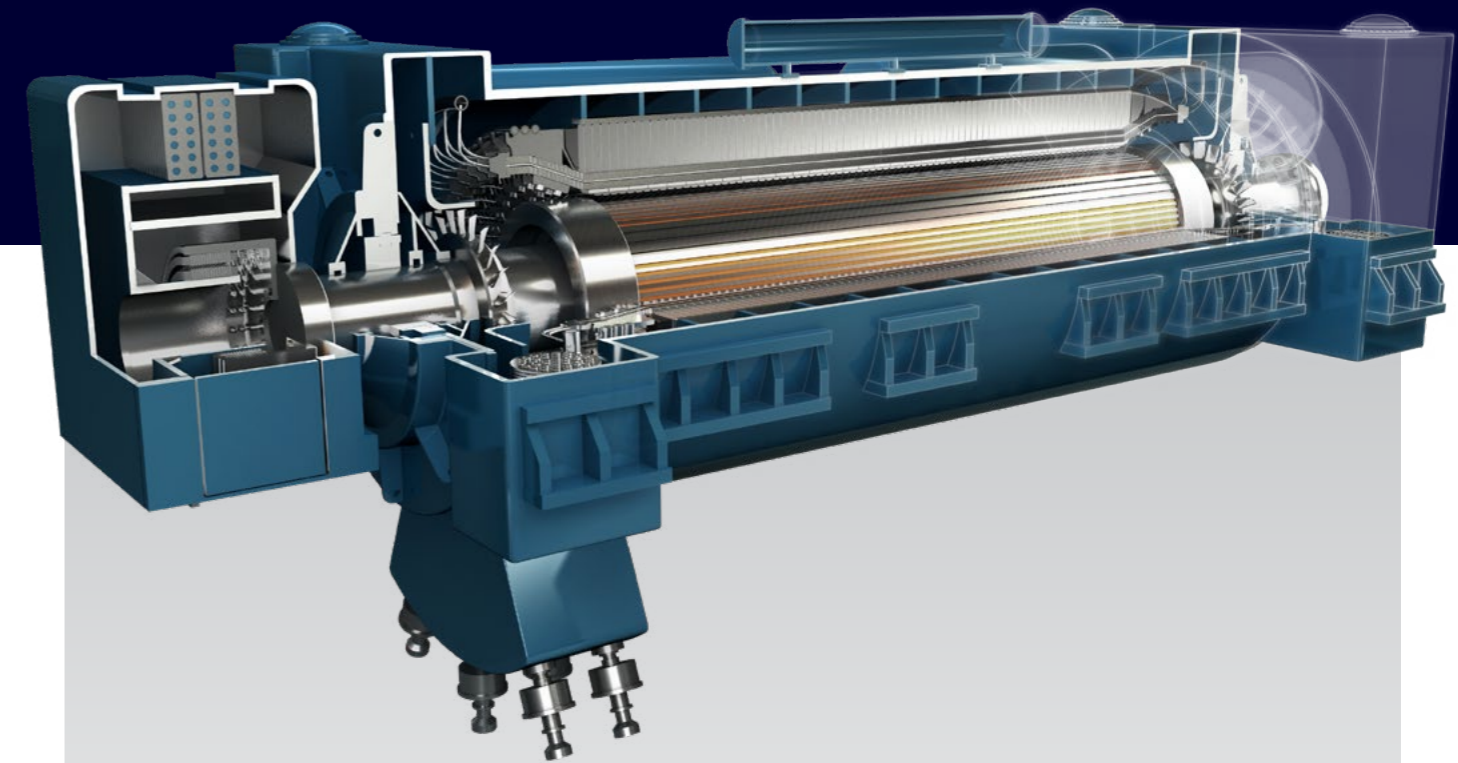

Frequency	50 Hz	60 Hz
Power Factor	0.85 to 0.9	0.9
Apparent Power	1,280 MVA to 2,235 MVA	950 to 2,000 MVA
Efficiency	Up to 99%	Up to 99%
Terminal Voltage	24 kV to 27 kV	22 kV to 26 kV
Reliability <sup>1</sup>	99.2%	

<sup>1</sup> Average reliability calculated according to standard IEEE-762 from measurements collected over 35 years from 58 GIGATOP 4-pole units.

### Success Story

#### Set for High Technical Performance

Nuclear power plants in France and China equipped with EPR nuclear reactors are benefiting from GIGATOP 4-pole technology, which enables outputs reaching up to 1,755 MW.

#### Advanced Solution

The GIGATOP 4-pole generator is designed for both rail and road transport. Only a small number of individual, separately packaged pieces are transported, speeding up installation and minimizing construction risk at site.





# Turbine Generator Package

## GIGATOP 2-POLE GENERATOR

Based on technology pioneered in the 1970s, the GIGATOP 2-pole generator has been installed in **100 systems since 1973**.

**Key Benefits:**

- **High power output levels.** Up to 1,200 MW.
- **Efficient and flexible.** The cooling system sustains a high level of efficiency and has a unique design of press plates for higher reactive power and stabilization in case of grid disturbance.
- **Robust and reliable design,** taking into account normal operation and transients.
- **Continuously evolving technology.** The first GIGATOP 2-pole generator was developed in the 1970s and has evolved continuously ever since, based on feedback collected from operating experience.

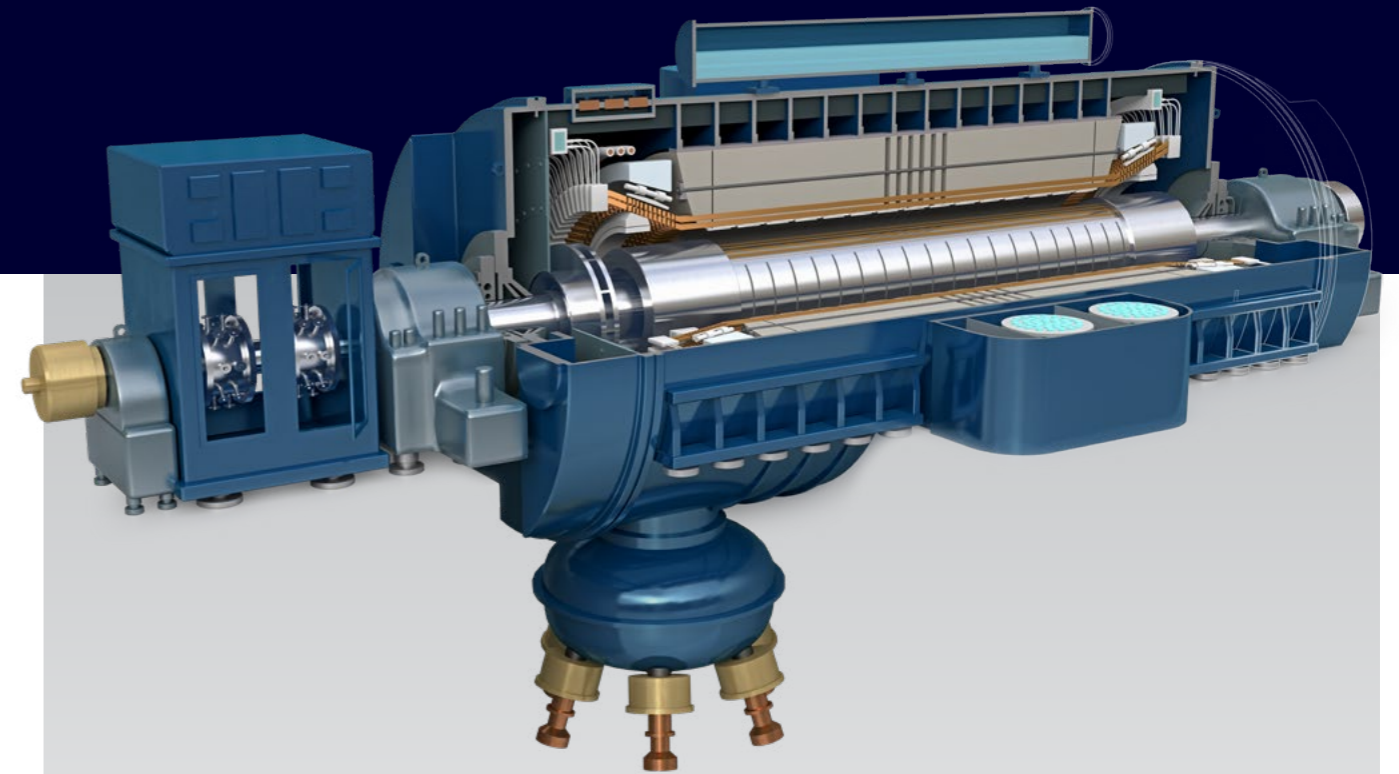
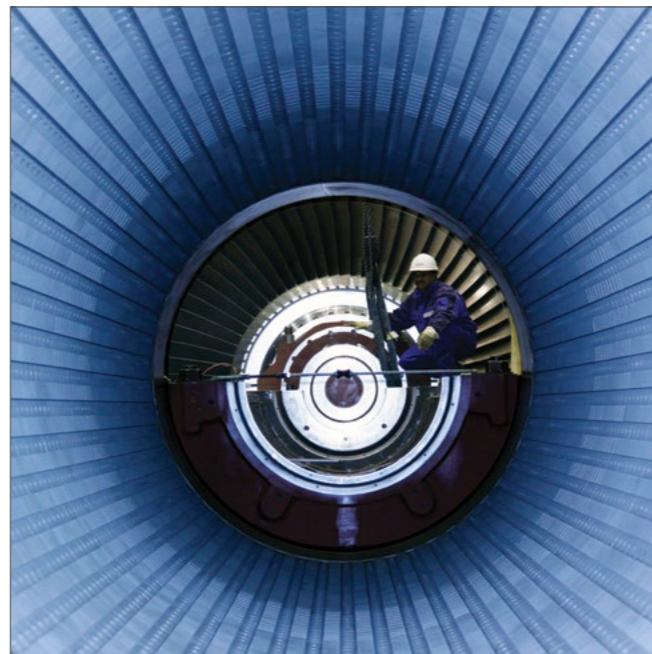

Frequency	50 Hz	60 Hz
Power Factor	0.8 to 0.9	0.85
Apparent Power	590 MVA to 1,400 MVA	510 to 1,120 MVA
Efficiency	Up to 99%	Up to 98.9%
Terminal Voltage	18 kV to 27 kV	22 kV to 26 kV
Reliability <sup>1</sup>	99.996%	

<sup>1</sup> Average reliability calculated according to standard IEEE-762 from measurements collected over 22 years from nine GIGATOP 2-pole units by the independent company Strategic Power System.

More than  
**100 units installed**

**Success Story**

**1,190 MW GIGATOP 2-Pole generator at site in Switzerland**

Switzerland: 1,190 MW GIGATOP 2-Pole generator. With commercial operation beginning in 1984, a nuclear power plant equipped with an 1,190 MW GIGATOP 2-pole generator contributes about 15 percent of Switzerland's annual energy production, or approximately 9 billion kilowatt-hours of energy.

## Turbine Generator Package

# AUTOMATION AND CONTROLS

**GE Steam Power Automation & Control provides a complete range of Control products and services including design and implementation, lifecycle services and asset management. GE's control systems are used in more than 200 nuclear units projected or installed.**

### Turbine Control Systems

GE's solutions for turbine control are generated from a unique association of the turbine manufacturer's expertise and the control systems manufacturer's expertise.

Avoiding unplanned outages is key. In addition to the highest availability features of Triple Modular Redundancy (TMR) architecture capability for asset control and protection, GE's Turbine Control Systems provide features for prevention and troubleshooting.

Without safety and security there is no sustainability. Safe operation is reinforced through IEC 61508 SIL3 certified components, fail-safe designs and TMR protection systems. GE's Turbine Control System with SIL-capable protection is designed for peace of mind, meeting the functional safety requirements of IEC 61508 and 61511.

GE has developed a strong expertise in qualifying control systems with respect to local regulations. Over the years, nuclear safety requirements have been reinforced and certain units' functions may need to be qualified according to the IEC 61513. GE's solutions for nuclear steam turbines are regularly improved to provide a high level of reliability and enable customers to meet the IEC61513 qualification.

### Key Benefits:

- Long term protection of your investment with a wide range of services and the use of a platform controlled over the full production
- Reliability and safety
- Embedded cybersecurity
- Operational flexibility improvement
- Specific regulation and grid codes compliance



### Excitation Systems

Today's power grid requirements are continuously changing to meet the needs of newer power sources. GE offers powerful excitation systems for the control of synchronous generators up to 10,000 Amps field current. It offers a wide variety of innovative solutions to maximize the efficiency of the power plant, as well as customized solutions to meet specific requirements.

### Key Benefits:

- Highly integrated with turbine and auxiliary controls for ease of troubleshooting with integrated equipment logs and Sequence Of Events
- Integrated solution packaged specifically to reduce maintenance costs
- Redundancy of controller & power part ensure continuous operation
- Enhanced reliability and system diagnostics with latest technology
- Minimal component design approach reduces spare parts requirements and improves system reliability



### Long Term Lifecycle Services

As one of the key OEM for the French Nuclear program, GE maintains more 700 000 electronic modules delivered since 1980 to the 58 French Nuclear Power Plants. With GE strong domain expertise and presence these components are kept in operational conditions under latest nuclear qualifications.

To ensure reliability and maintainability of our installed base while minimizing automatic reactor shutdowns, GE's objective is to deliver first class quality products and services in full compliance with high demanding nuclear codes and standards. To reach those standards GE maintains and develops a robust base of competencies and tools specialized in both nuclear automation and nuclear processes.

This team covers the full life cycle of the project from tendering and design to production, delivery, installation and maintenance and is supported by a specific electronic boards manufacturing unit qualified by our key customer EDF.

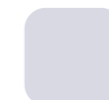
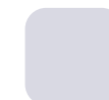



# Turbine Generator Package

## HEAT EXCHANGERS

### Increased Efficiency with Cost-efficient Heat Exchangers

Heat exchangers are key to the efficiency of the steam and water cycle. Each configuration provides a cost-effective balance between **enhancing performance while maintaining reliability levels**, and addressing plant's requirements, operating objectives, and environmental constraints.

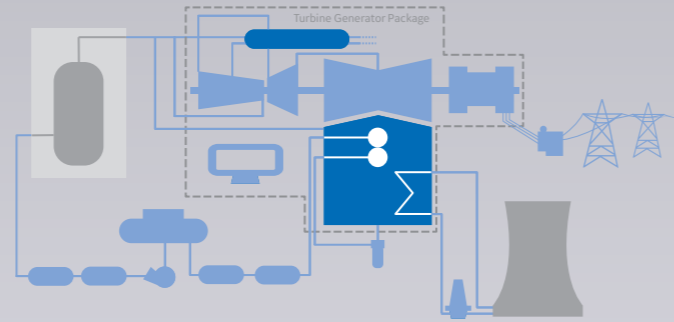

Intermediate reheat conditions and the backpressure of low-pressure turbines can affect moisture separator reheaters (MSR) and condensers, which contribute to cycle efficiency. GE's design of MSRs, surface condensers and heaters allows optimum integration with the steam turbine in the thermodynamic cycle.

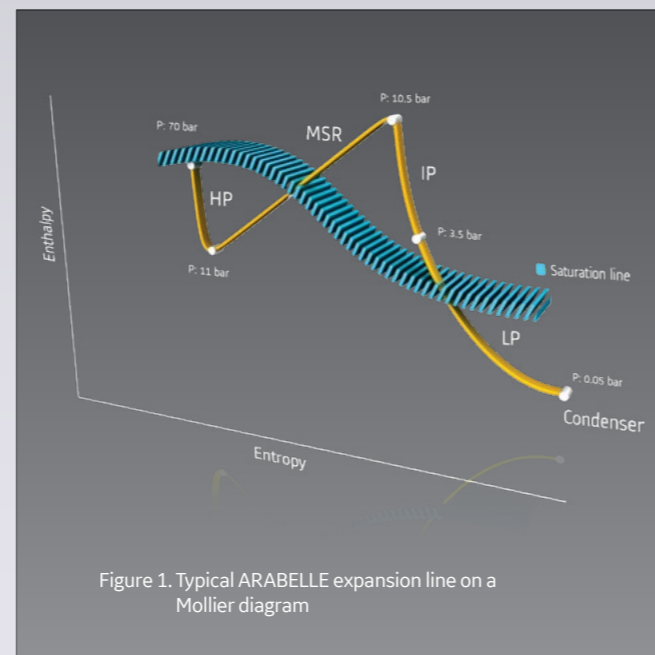

Figure 1. Typical ARABELLE expansion line on a Mollier diagram

GE's expertise in thermal power plants is reflected in the installed base of **more than 450 GW with equipment rated up to 1,750 MW electrical output.**

## Operational flexibility and high reliability





Turbine Generator Package

# MOISTURE SEPARATOR REHEATERS

## Boosts Thermal Cycle Efficiency of Nuclear Plants

With an installed fleet of more than **678 new Moisture Separator Reheaters (MSRs) and 80 retrofits**, GE has proven field experience to improve efficiency, to raise performance, and extend the MSR's service life.

The function of an MSR in a nuclear power plant is to remove moisture and to superheat the steam, thus **avoiding erosion corrosion** and **droplet impingement erosion** in the low pressure turbines.

### Key Benefits

- **Efficiency.** As an integral part of the turbine generator package, the MSR configuration and technical parameters are designed for **increased power output**.
- **Adaptability.** Can be adapted to all existing reactor outputs up to 1,900 MWe and can meet a **wide range of sizes, arrangements and system design requirements**.
- **Reliability.** Its extensive installed base (200 units in operation) demonstrates **40 years of excellent operation**. First-generation MSRs are still in operation today.
- **Availability.** Increases the availability of power generation, thanks to its **track record of high reliability** and reduced maintenance. It also offers quick-start operation.

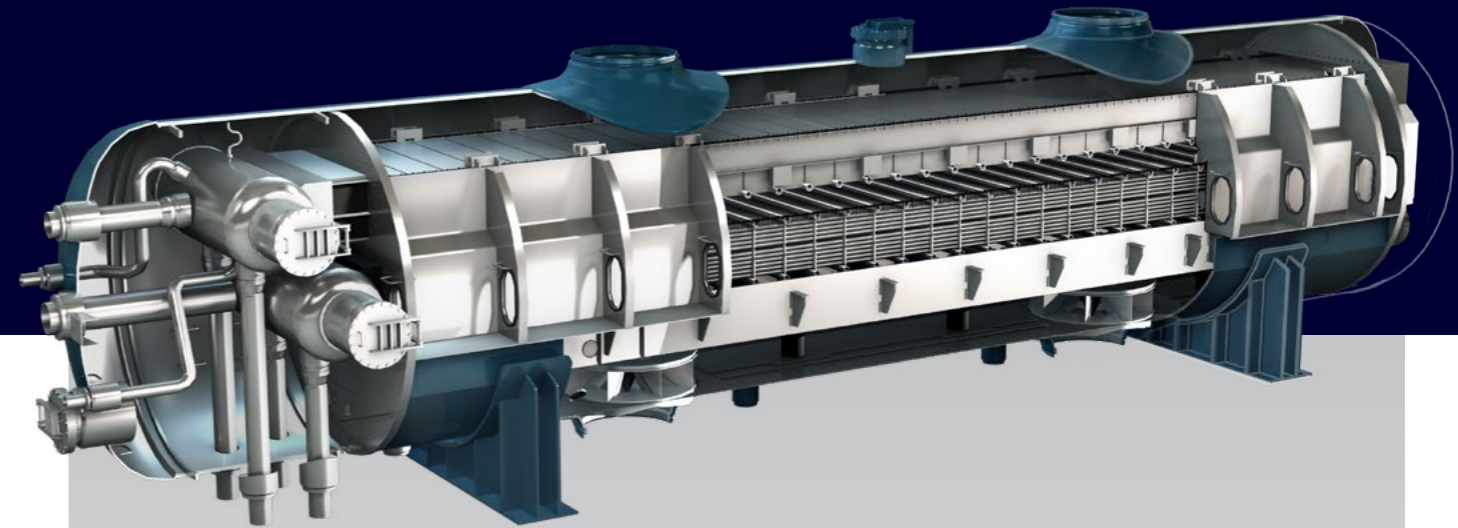

Typical Reference Solutions for:	1000 MW	1200 MW	1750 MW
<b>Installation</b>	Horizontal	Horizontal	Vertical
<b>Type</b>	2 Reheat Stages	2 Reheat Stages	2 Reheat Stages
<b>Quantity per TG Set</b>	2	2	2
<b>Cycle Steam Inlet Massflow (kg/s )</b>	620	700	1000
<b>Inlet Pressure (bar a)</b>	10	11	12
<b>Moisture Separation</b>			
<b>Inlet Moisture (%)</b>	14	14.5	15
<b>Outlet Moisture (%)</b>	0.5	0.5	0.5
<b>1<sup>st</sup> and 2<sup>nd</sup> Stage Reheater</b>			
<b>Tube Type</b>	U-finned	U-finned	Straight-finned
<b>Tube Material</b>	Ferritic Stainless Steel	Ferritic Stainless Steel	Ferritic Stainless Steel
<b>Tube-tubesheet Joint</b>	Expanded/Welded	Expanded/Welded	Expanded/Welded
<b>MSR Shell</b>			
<b>Diameter (m)</b>	4.3	4.3	5.8
<b>Straight Length (m)</b>	18.6	18.8	16.2
<b>Material</b>	Carbon Steel Plate	Carbon Steel Plate	Carbon Steel Plate
<b>Weight</b>			
<b>In Operation (tons)</b>	260	265	440
<b>Flooded (tons)</b>	520	540	860

## Success Story

### Finland: New MSR Installation in Record Time

A combined moisture separator reheater (MSR) and high-pressure (HP) turbine retrofit project was installed in a record 19 days at a 870 MW power plant in Finland.





# Turbine Generator Package CONDENSERS

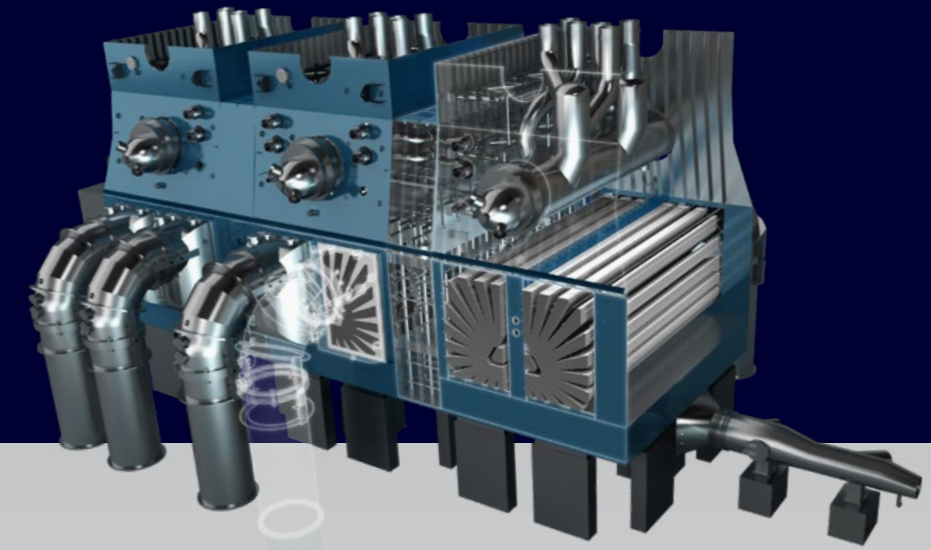

## Proven Technology for Higher Plant Performance

For 50 years, **more than 700 of our condensers** have been engineered, commissioned and delivered. Over the past 35 years, we have **retrofitted more than 70** condenser tube bundles and **set a record of 19 days** for a 900 MW NPP retrofit.

GE condensers are designed for each specific installation, meeting **sustained high-performance requirements**, enhancing reliability, adapting to varied site cooling conditions, and providing **simplified construction** with pre-assembled modules.

## Key Benefits

- **Higher performance and reliability.** Features a patented tube bundle design (the Daisy bundle) and a **track record of outstanding performance over the past 50 years.**
- **Greater efficiency.** Includes **highly efficient tube bundles** that are scaled to meet the needs of any size power plant.
- **Reduced costs, simplified construction.** Provides floor mounting, which shortens civil works and construction time. Condensers are delivered as fully tubed modules, so that little welding is required on site. The condenser houses the first two stages of low pressure heaters for simplified arrangement of the turbine building.
- **Robust design for flexible operation.** Is designed to handle turbine and steam generator overloads and variations in cooling water temperature. It is resistant to impingement erosion and tube vibration.

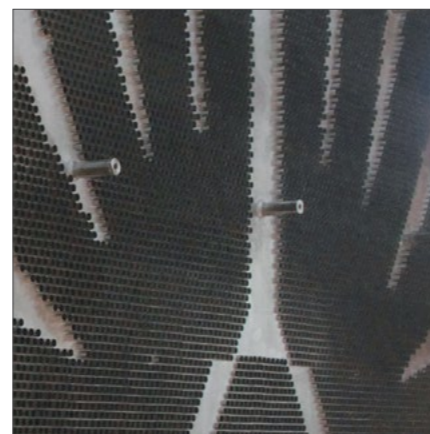

Condenser tube sheet

Typical Reference Solutions for:	1000 MW	1200 MW	1750 MW
<b>Condenser Vacuum Type</b>	Single	Dual	Single
<b>Condenser Thermal Load (MW)</b>	1,820	2,030	2,860
<b>Absolute Pressure at Turbine/Condenser Connection (mbar abs)</b>	55	52/70	60
<b>Max Condensate O<sub>2</sub> Content at 100% Load (ppm)</b>	20	20	10
<b>Circulating Water</b>			
<b>Circulating Water Temperature Design (°C)</b>	25	22	25
<b>Circulating Water Nature</b>	Seawater, Once-through	Fresh Water, Cooling Towers	Seawater, Once-through
<b>Circulating Water Flow (m<sup>3</sup>/s)</b>	63	40	90
<b>Circulating Water Temperature Rise (°C)</b>	7	6/6	8
<b>Tubes</b>			
<b>Exchange Surface (m<sup>2</sup>)</b>	76,000	70,000	115,000
<b>Material</b>	Titanium	Stainless Steel	Titanium
<b>Length (m)</b>	16.5	15	14.1
<b>Tube to Tubesheet Joint</b>	Expanded/Welded	Expanded/Welded	Expanded/Welded
<b>Weights</b>			
<b>Operation (tons)</b>	2,200	3,450	3,410
<b>Water Filling (tons)</b>	3,600	4,600	11,350
<b>Dimensions</b>			
<b>Hotwell Bottom to Turbine (m)</b>	13	16.5	17.1

## Success Story

### France: Successful Condenser Modular Upgrade for Increased Performance

In 2008, the condenser at a 900 MW nuclear power plant in France was upgraded, increasing performance by about 10 percent thanks to the compactness of the Daisy bundle design.

# FEEDWATER PLANT PACKAGE

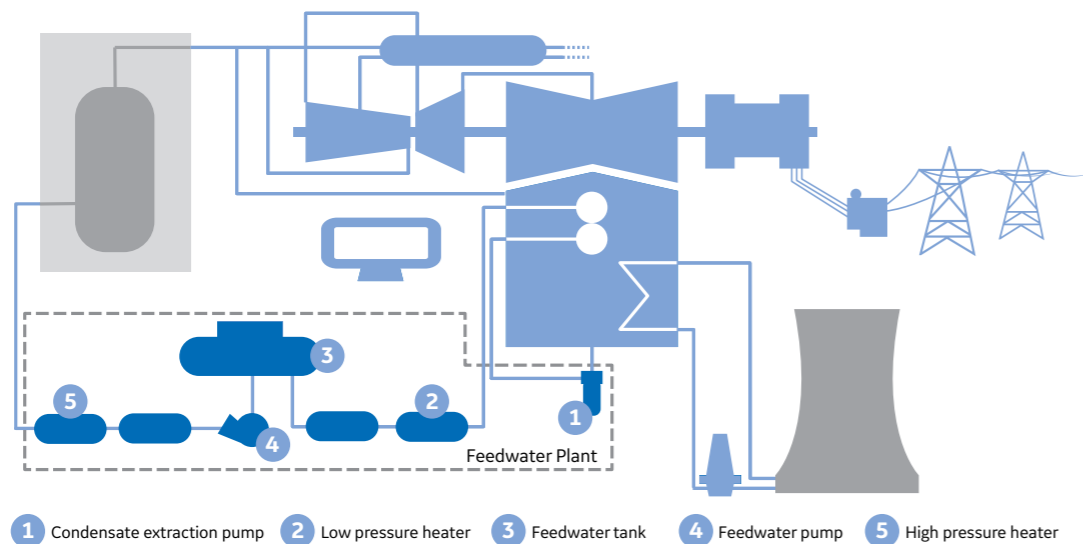

1 Condensate extraction pump 2 Low pressure heater 3 Feedwater tank 4 Feedwater pump 5 High pressure heater

GE integrates heat exchangers and pumps in the portfolio and brings insight into the steam/water cycle integration. Quantitative analysis and heat balance models help determine a **preferred configuration**. Customers can expect **operational flexibility, high efficiency and reliability**, and overall **cost effectiveness**.

## 1 Condensate Extraction Pump

The condensate extraction pumps are the vertical multi-stage bowl diffuser type, or can type, with a single- or double-suction impeller. The can is arranged in a pit below the installation floor. We offer **various configurations**, with or without a pump in stand-by. Variable speed drives are available for all types of reactors and specifications, including large flow requirements. The pumps are designed to **operate safely and economically** at full speed on a large operating range, including partial load conditions.



## 2 Low Pressure Heaters

Low pressure feedwater heaters in a nuclear power plant can improve the thermodynamic efficiency. Our custom-manufactured LP heaters offer **outstanding reliability**, eliminating the need for additional bypass and valves and improving the availability of the plant.



## 3 Feedwater Storage Tank and Deaerator

This combined unit performs three functions: it eliminates all oxygen to avoid any damage to the nuclear steam generator, it heats the feedwater with a steam extraction from the turbine, and it provides a reserve of deaerated and heated water, necessary for correct plant operation.



## 4 Feedwater Pump

Our first feedwater pump was introduced in 1970. Since that time, these pumps have demonstrated **reliability and outstanding performance** under all operating conditions. Today, more than **68 pumps are in operation**.



The current generation of feedwater pumps delivers consistent **steady-state performance at nominal load**.

## 5 High Pressure Heaters

High pressure heaters are used in a regenerative water-steam cycle to **improve the thermodynamic cycle** of the plant. Our HP heaters are of the shell and U-tube type. Feedwater passes through the tubes heated by steam on the shell side. The U-tubes are welded in the tubesheet, and the tube coils are welded onto the header nipples.



## Success Story

### China: Turbine Island for 1,750 MW Nuclear Power Plant

GE is supplying critical technology to a Taishan power plant, the largest in the world, with two 1,750 MW units.





# HEAT REJECTION SYSTEM

Heat rejection design has a major **impact on a plant's overall efficiency**. The correct cooling system configuration and sizing of the heat rejection loop are critical elements to getting the most from a selected site.

Depending on site characteristics, cooling can be by water in a once-through arrangement when large bodies of water are available (sea or large river) or by ambient air through natural or mechanical draft cooling towers. A colder cooling fluid will create a better vacuum in the condenser and allow more steam expansion through the turbine, **delivering increased power output**.

For enhanced power plant performance, the selection of the heat rejection configuration focuses on **operating conditions** throughout the year and the **heat sink's configuration**. We perform quantitative analyses before choosing the **most economical solution**, considering water or air temperature variations and the selling price of the electricity produced.

Once-Through	Cooling Tower
Location close to a large body of water	Location where only make-up water is available
Lowest condenser pressure and lowest cost Dependent on local regulations and water access rights	Lower efficiency, larger footprint Applicable in many locations
Single pressure condenser is preferred	Multi-pressure condenser is generally preferred

## Tailored solutions to fit site characteristics



Flamanville nuclear power plant

Several configurations can be considered, with concrete volute pumps or vertical turbine pumps:

- Concrete volute pumps usually provide the best performance, with higher overall efficiency and reliability. Circuits remain simple, without isolation valves.
- Concrete volute pumps can be located either in a dedicated pumping station (once-through and cooling tower configuration) or directly in the turbine hall (cooling tower configuration).
- Vertical turbine pumps can bring additional flexibility in a four-pump configuration with common header for distribution.

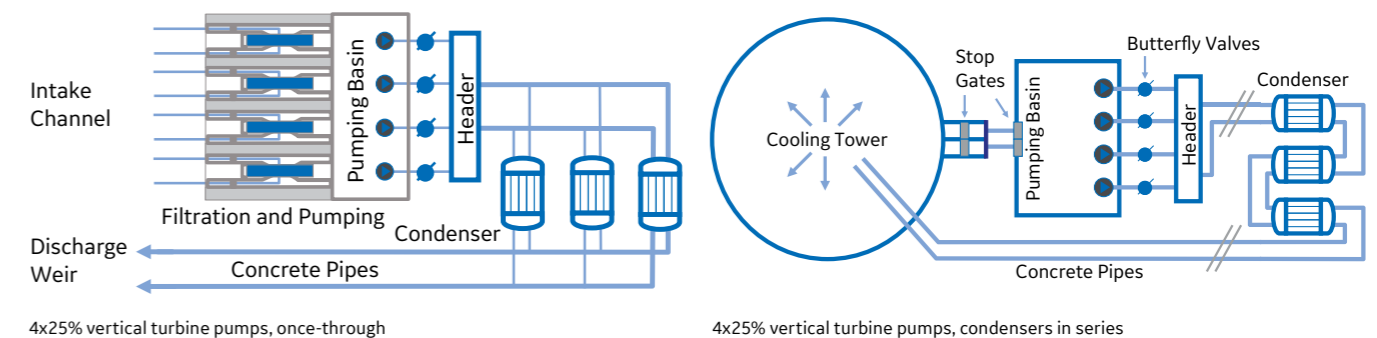
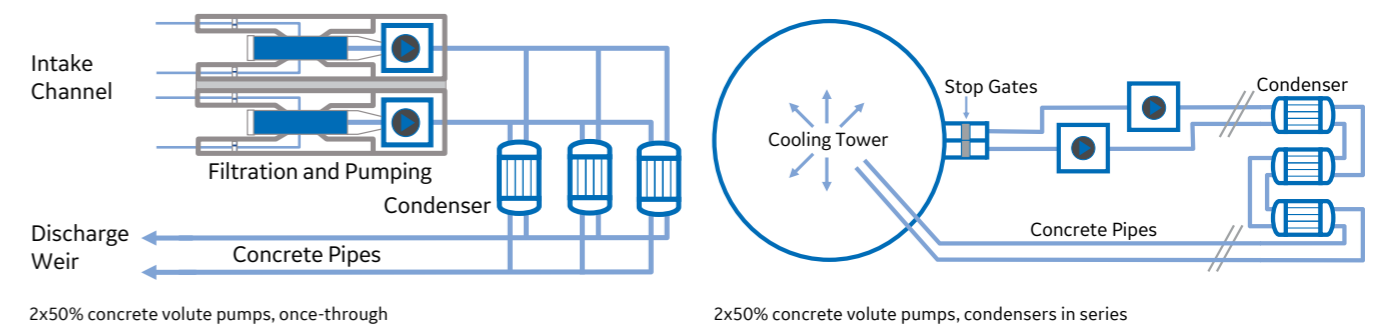



# HEAT REJECTION SYSTEM

## Concrete Volute Pumps

Concrete volute pumps offer high reliability, averaging above **99.9 percent in more than 30 years of proven operation**, with a very high flow rate (up to 40 m<sup>3</sup>/s). They consist of:

- Suction duct, with different shapes available
- Volute, shaped and designed for hydraulic efficiency and easy installation
- Mechanical parts, which are embedded in the concrete
- Pull-out part, consisting of the centrifugal impeller, shaft, bearings, etc., for easier maintenance

A simple design with minimal components and **enhanced corrosion-resistant features** makes concrete volute pumps particularly suitable to sites where large volumes of water must be pumped. Benefits include:

- **High reliability**, as demonstrated by experience
- **Lower service cost**, with simple overhaul at intervals of eight to 10 years
- **Enhanced operating performance**, with higher efficiency, and lower noise and vibration

## Vertical turbine pumps

GE's proven vertical turbine pumps are highly efficient for condenser cooling and provide **excellent reliability**. Configurations include: discharge flange above or below pump floor, motor supported on pump head or on a separated support, and pump pull-out or non-pull-out. Our vertical turbine pumps consist of:

- Hydraulic module with a higher level of efficiency with axial, mixed flow or centrifugal impellers
- Shaft line, which is immersed in the pumping fluids or with an independent flushing system
- Fabricated casing, which includes the delivery column and elbow

A proven solution for harsh water quality, our vertical turbine pumps offer the following advantages:

- **Higher efficiency**
- **Modular design** for tailored solutions
- **Higher reliability** with experience in duplex material for sea water application
- **Easier maintenance** with GE's simple, light and efficient design



## Success Story

### France: Concrete Volute Pumps for 1750 MW Plant

Our turbine islands, including circulating water pumps, were supplied to a nuclear plant in France that began operation in 1985 with two 1,350 MW units. An 1,750 MW extension now under construction will include a complete ARABELLE steam turbine island including the circulating water pumps in a dedicated pumping station. Two concrete volute pumps will feed three condensers with more than 60 m<sup>3</sup>/s of sea water.



Can GE  
refurbish  
my nuclear  
turbine island?

# YES.

OPG appointed GE as the project leader for the refurbishment of the steam turbines, generators and automation and controls for the 4 Darlington units. GE was selected to lead the refurbishment project thanks to our extensive experience in nuclear energy, with 50% of the world nuclear power plants equipped with our technology and more than 120 multi-year agreement for services. The project will extend the plant life by 30 years.

**This is the Power of Yes.**







## The GE Store

### **DRIVING COMPETITIVE ADVANTAGE ACROSS OUR BUSINESSES**

We drive enterprise advantages that benefit the entire company through what we call the “GE Store.” It means that every business in GE can share and access the same technology, structure and intellect. The value of the GE Store is captured by faster growth at higher margins; it makes the totality of GE more competitive than the parts. No other company has the ability to transfer intellect and technology the way GE can through the Store.

**Our Customers  
Determine Our Success.**





When it comes to our customers' most pressing questions, our answer is YES. It's a small but meaningful word that ensures the power is on for everyone, everywhere. At GE, we are transforming the future of steam power, creating extraordinary outcomes for tomorrow and beyond.

**This is the Power of Yes.**

Visit us to learn more  
[gepower.com/powerofyes](http://gepower.com/powerofyes)





\* Trademark of General Electric Company.

© 2019, General Electric Company and/or its affiliates. GE Proprietary Information. All Rights Reserved. No part of this document may be reproduced, transmitted, stored in a retrieval system nor translated into any human or computer language, in any form or by any means, electronic, mechanical, magnetic, optical, manual, or otherwise, without the prior written permission of the General Electric Company or its concerned affiliate.

Information contained in this document is indicative only. No representation or warranty is given or should be relied on that it is complete or correct or will apply to any particular project. This will depend on the technical and commercial circumstances. It is provided without liability and is subject to change without notice.

GEA31902A (10/2019)