

Grid IQ™ Microgrid Control System

Optimization Solution for Permanently Isolated or Grid-Connected Microgrids

The Grid IQ Microgrid Control System (MCS) enables distribution grid operators to integrate and optimize energy assets with an objective to reduce the overall energy cost for a local distribution grid, also known as a “microgrid”.

The MCS is based on a supervisory control architecture provided by the Multilin™ U90^{Plus} Generation Optimizer, Intelligent Electronic Devices (IEDs), substation gateways, a Human Machine Interface (HMI) and a secure communications network.

The MCS provides a simple yet effective solution to integrate fossil fuel based (dispatchable) Distributed Energy Resources (DERs), renewable (non-dispatchable) DERs and energy storage to best optimize the operation of a local microgrid with a goal to minimize the total cost of operation, including Cost of Energy (CoE).

Key Benefits

- Enables integration of renewable energy resources such as wind turbines or solar PV with conventional fossil based generators
- Optimizes the dispatch of distributed energy system resources to reduce the total cost of energy and cost of operating a microgrid system
- Maintains a secure and reliable power supply for mission critical loads with ability to operate in ‘islanded’ mode
- Enables integration with Volt/VAR controls for a better utilization of existing or new distribution system assets to further reduce system losses and increase overall system efficiency
- Maximizes the use of renewable assets for reduced GHG emissions and environmental impact

Application Specific Solutions

- Off-the-grid remote communities: Opportunities to optimize operation of diesel generators and integration with renewable energy resources
- Military bases: Provides reliable power for critical loads at military bases in case of an unwanted interruption of power from the main grid
- Mining communities: Opportunities to best utilize the available energy resources and help reduce diesel consumption for community energy needs



Generation Optimization

- Provides substantial reduction in fuel costs by intelligent management of generating assets
- Maximizes the use of renewable generation by leveraging the available energy storage system

Holistic Energy System

- Integrates electrical and thermal energy assets such as CHP and boilers
- Maximizes overall system optimization and minimizes the total energy costs

Improved Return on Investment

- Enables integration of existing power system assets to the new infrastructure for an improved asset utilization
- Further reduces distribution system losses through the integration of Volt/VAR controls

Reliable Power

- Maintains uninterruptible power supply for mission critical infrastructure with ability to operate in ‘islanded’ mode
- Manages turn on/off operation of low priority controllable loads in case of generation deficit situation within the “islanded” microgrids

Microgrid Visualization

- Empowers local microgrid system operators to make informed decisions by providing system visualization
- Provides a man-machine interface to configure and monitor the microgrid system for automatic dispatch of DERs

What is a Microgrid

A microgrid is an integrated energy system with local Distributed Energy Resources (DERs) such as local loads, generating assets and possibly energy storage devices such as batteries or fuel-cells. A microgrid system is typically capable of operating in "islanded" (off-the grid) or grid-connected mode. Based on the grid connection "status" of a microgrid, it can be categorized as:

Permanently Islanded Microgrid

Permanently Islanded microgrid networks are stand alone networks that must produce all of the generation locally that will be consumed by the loads in the network. Islanded microgrid networks are quite often found in remote, northern or island communities where the high cost of importing fuel and the availability of renewable resources (wind, hydro) can make optimization of generation resources very desirable.

Grid-Tied Microgrid

Grid-tied microgrid networks are able to produce power within its distribution networks as well as import power from a utility source. University campuses and military facilities that have on-site generation for backup power can utilize their on-site generation to offset the costs of electricity when it is cheaper to produce electricity than to buy it.

MCS Components

The MCS is based on a supervisory control architecture provided by Multilin U90^{Plus} Generation Optimizer.

The core function of the U90^{Plus} Generation Optimizer is its ability to monitor, track, and forecast load and generation resources within the microgrid. In order to facilitate this, the U90^{Plus} is required to communicate with intelligent controllers distributed at key points across the microgrid.



Grid IQ's MCS is a system solution offering with the U90^{Plus} Generation Optimizer as "heart" of the control system, surrounded by intelligent controllers, communications and other power system devices.

U90^{Plus} Generation Optimizer

The U90^{Plus} Generation Optimizer is the central engine of an advanced microgrid control solution that provides management of DERs for the most economical power. A detailed functionality description of the U90^{Plus} controller is provided in following sections.

Typical Microgrid Control System Architecture and Optimization Sequence

The U90^{Plus} is the central supervisory controller of a microgrid control system that maximizes the use of the renewable DERs and provides set points for various energy resources to provide power for the load demand in the most economical method possible.

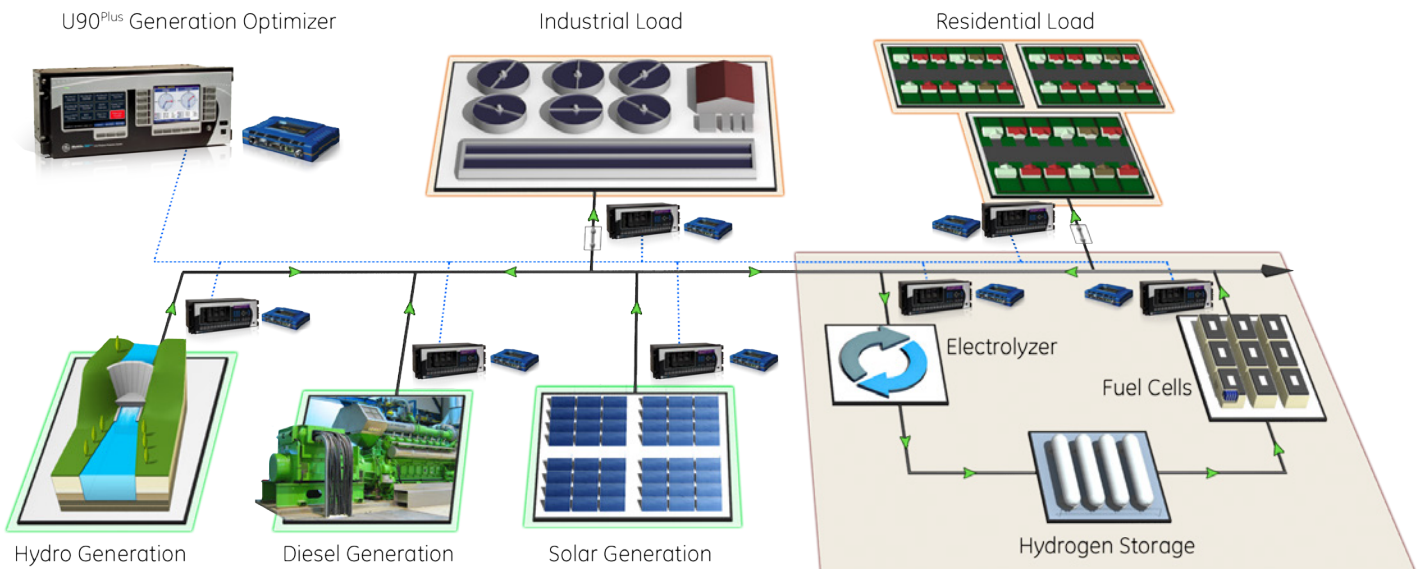

Communications Network

The U90^{plus} is able to measure load requirements and generation capacity at various locations across the microgrid network. As these load and generation centers are spread out geographically, a reliable and robust communications network is provided in order for the U90^{plus} to monitor and control various assets with in the spreadout power system network. Where economical to do so, an Ethernet network can be deployed at each critical measurement point. When the microgrid spans long distances or laying fiber optic cables is uneconomical, a secure, industrial wireless network can be deployed. The U90^{plus} minimizes the amount of information needed to be transmitted over the communications network by optimizing the data requirements at each load or generation location.

Intelligent Local Controllers

Each generating source and energy storage unit is monitored, and receives commands from the U90^{plus} by an intelligent controller located locally at DER locations. These controllers perform the real time measurements of the load or generating units and communicate back to the U90^{plus}. These controllers also receive the commands from the U90^{plus} to initiate the turning on or off of the dispatchable generators.

These intelligent controllers are required to support the Modbus TCP/IP protocols and have the appropriate control capability to interact with the generator or storage unit control systems. Multilin's Universal Relay family is an ideal solution as it contains the necessary control and protection functions to protect the assets at the same time.

Integration and Configuration Services

The MCS offering includes microgrid system feasibility studies, engineering, system design and modeling, U90^{plus} Generation Optimizer configuration, first level system integration services, system commissioning support and training. GE has a team of subject matter experts to help develop and build a microgrid project.

Grid IQ MCS Features

The MCS provides a multitude of functionalities for permanently isolated (off-the-grid) and grid-connected microgrid systems.

Lowers Cost of Producing power

Through its ability to monitor and trend key load, the U90^{plus} is able to predict the load requirements within a microgrid for future periods through a smart dispatch mechanism. The smart dispatch send commands to dispatchable generators to meet these load requirements in the most economical method possible.

Maximizes Use of Green Power

When renewable generation (hydro, wind, solar) and methods of storing power (hydrogen, battery, pumped storage) are available, the U90^{plus} is able to maximize the use of DERs by enabling energy storage when it determines there is excess renewable power available or it is economically viable to do so. At a later time when there is not enough renewable generation to support the load, the U90^{plus} can dispatch this low cost stored energy to meet the load requirements in the most efficient manner possible.

Load Forecasting

The capability of the U90^{plus} to forecast the future load requirements is key to providing the optimum generation to support the load. All loads are continuously tracked and used by the U90^{plus} to create a forecast for the load profile of the microgrid for the next 24 hours.

If the actual measured load usage differs from what the U90^{plus} forecasts for reasons such as a drop in temperature resulting in less load requirements, the U90^{plus} will continually adjust its forecast to make the best predictions for load requirements.

Typical Distributed Energy Resources (DERs) for Microgrid Systems

The U90^{plus} can integrate many different types of Distributed Energy Resources into its generation optimization control algorithms.

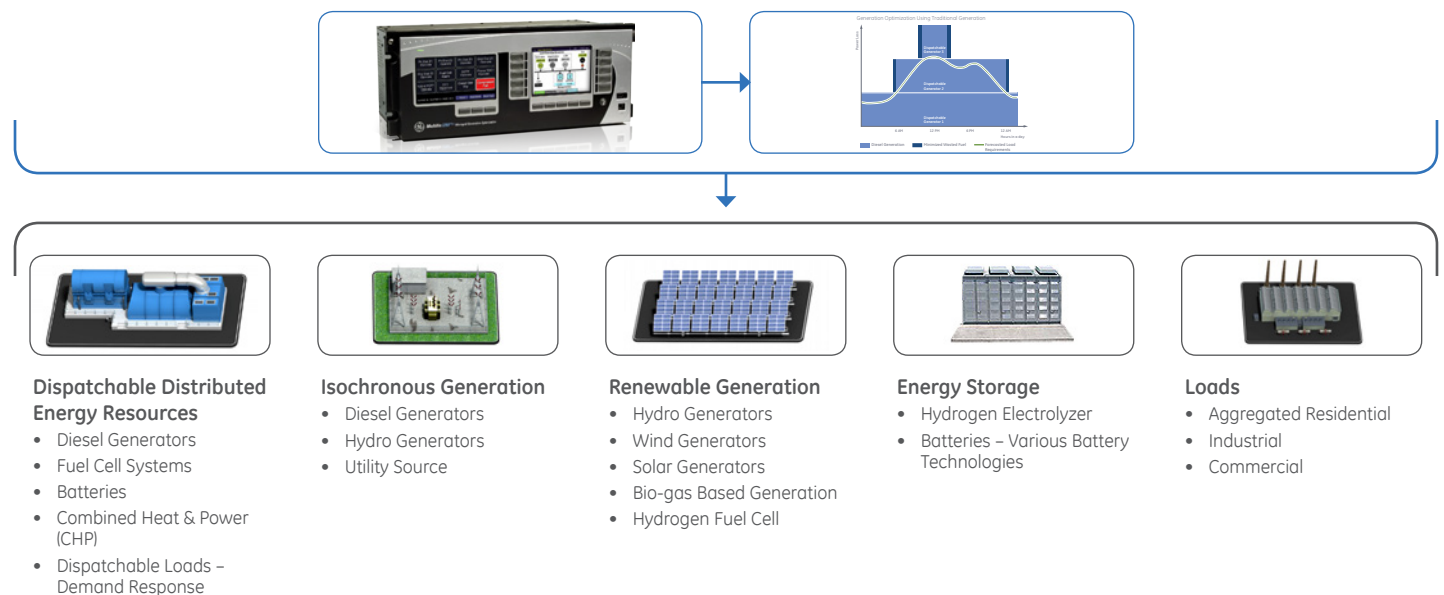

If the local utility or campus has the ability to perform advanced load requirement forecasts that could be used instead of or to compliment the forecasts made by the U90^{plus}, these forecasts can be uploaded into the U90^{plus} for use in its optimization calculations. Note that if the U90^{plus} measures that this external forecast is not matching the actual load profile, it will adjust the uploaded forecast to more accurately match what is being used in the microgrid.

Generation Forecasting

The distributed generators that are connected to the microgrid are currently monitored by the U90^{plus} and their output is constantly tracked. A forecast for the expected output of generation from renewable sources over the next prediction horizon (e.g. 24 hours) is then created to predict the contribution to the overall generation that will be supplied by these renewable sources.

Similar to the load forecast predictions, if the actual measured generation from available sources differs from what the U90^{plus} forecasts for reasons such as a drop in wind or an increase in clouds as compared to previous days, the U90^{plus} will continually adjust its forecast to make the best predictions for the contribution of renewable generation that will be available to support the required loads in the microgrid.

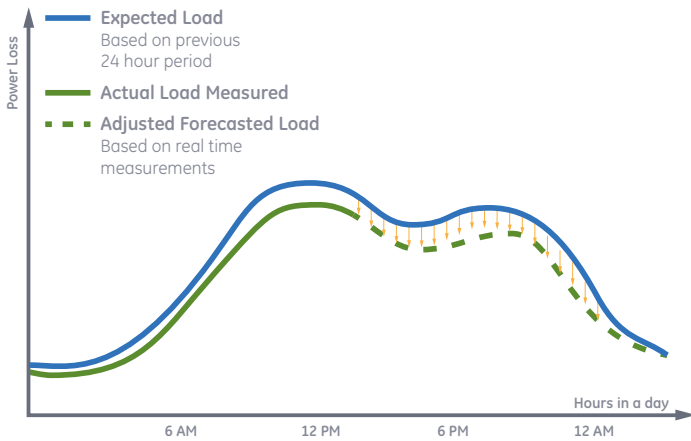

The U90^{plus} develops a 24 hour expected load profile for which it will provide the necessary generation within the system to support it. If the actual measured load is different than the forecasted load, the U90^{plus} will continually adjust the forecast to provide the appropriate generation.

Optimal Generation Dispatch

Using the load profile that was created based on historical power usage and adjustments made on real time monitoring, the U90^{plus} will optimize the use of the available generation to provide power in the most economical means possible.

As a part of the configuration process of the U90^{plus}, each generation source is given a cost value to run that generating source. Renewable generators such as wind or solar power will be given a lower cost than diesel or other fuel based generators. Using this information, along with the operating and efficiency characteristics of the generators, the U90^{plus} will give commands to the dispatchable generators and/or storage devices to best match the generation with the load requirements.

In order to use the minimal amount of fuel required to support the load, the U90^{plus} will turn on the dispatchable generators just before needed in order to minimize the idling time of the generators to provide the most cost effective method in supporting the load.

As a part of its generation optimization algorithms, the U90^{plus} takes into account the operational characteristics of the generators such as the start up time required and the minimal generation loading that is require to make it operate efficiently.

The U90^{plus} performs its generation optimization calculations and sends commands to the generators to maximize generator performance every 12 minutes. As changes in the load occurs between 12 minute optimization cycles, the U90^{plus} ensures that it took into account enough generation loading margin known as "Isochronous Generator Margin" or "Isoc Margin" to support the addition to the load.

Generation Optimization Using Traditional Generation

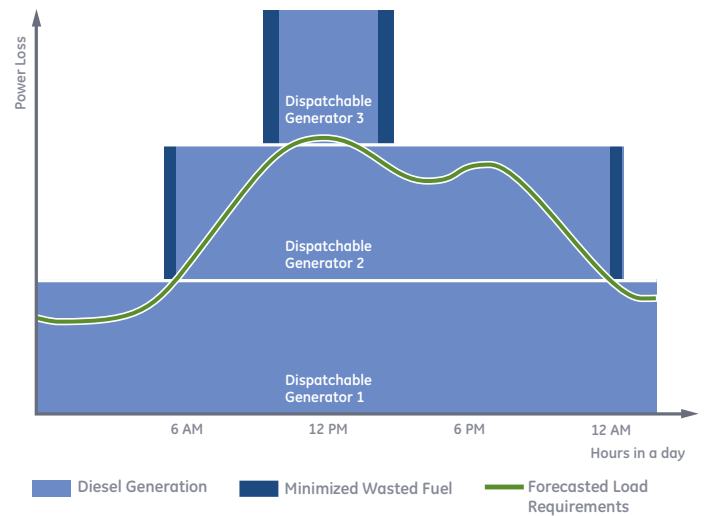

The U90^{plus} generation optimization algorithms intelligently start and stop the dispatchable generators at the optimal times to support the load and minimize the time the generators are running.

Generation Optimization with Integrated Renewable Generation

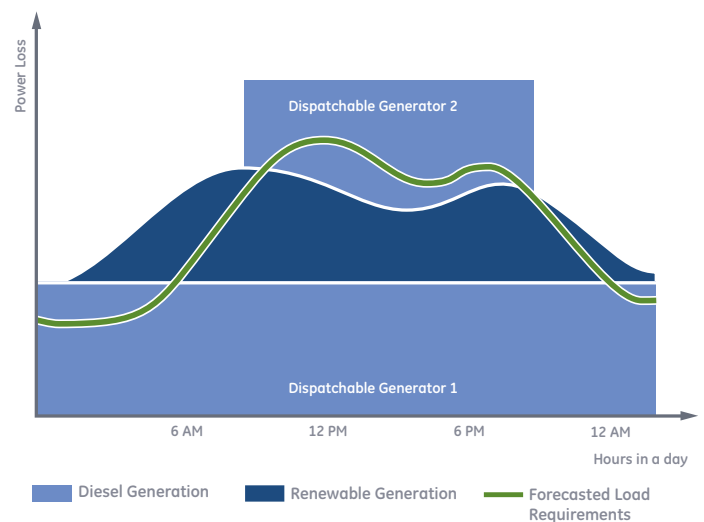

As it is not dispatchable, when renewable generation is integrated into the microgrid system, the U90^{plus} will dispatch available generation taking into account the contribution of renewable generation into the system.

Renewable Generation Integration

Using the forecasts made for the amount of renewable generation that will be available in the microgrid, the U90^{Plus} is able to provide additional cost savings in the microgrid network. By taking into account the amount of renewable generation that will be available for future periods, the U90^{Plus} will reduce the amount of dispatchable fossil fuel based generation running to meet the load requirements.

Since by its nature renewable generation is variable and can very quickly decrease in contribution to the system (wind slows or increased cloud cover), the U90^{Plus} will incorporate an additional margin of standby generation (Isoc Margin) when renewable contribution is high to ensure there will always adequate generation available to support the load.

Isochronous Generation Control

The isochronous generators (or "isoc generator" are the generators in the microgrid that are used to stabilize the frequency of the system. Based on a pre-defined configuration, the U90^{Plus} is able to identify which generators are the isoc generators as specified by preference of the system operators.

The types of generators that can be used as an isoc generator in the microgrid are defined below:

- Utility source
- Diesel generator
- Hydro generator
- Fuel cell generator
- Battery

Energy Storage Integration

When a method of storing energy is available, (hydrogen electrolyzer or batteries) renewable generation can be used to its maximum potential for providing cost savings. Energy storage is possible since low cost energy does not need to be used at the exact time that it is produced, therefore it can be used later when renewable sources may not be available.

Storing Energy

During periods of time where there is more renewable generation available than is required to support the load (such as spilling over the dam at night for hydro), or when there is additional generation margin due to lightly loaded generators, the U90^{Plus} can initiate the hydrogen production or storage (battery or pumped storage) of "fuel".

Using cost information that was entered at the time of configuration of the U90^{Plus}, the optimization algorithms in the U90^{Plus} analyze the excess generation available and determine if it is economically beneficial to store energy at that time. The U90^{Plus} will take into consideration the amount of time it takes the storage medium, to operate efficiently and how long it must run for prior to seeing benefits, before it initiates the storage process.

Using Stored Energy

When there is not enough renewable generation in the system to support the load requirements and there is sufficient stored energy available to support the loads, U90^{Plus} will initiate the use of available stored energy and will help reducing the fossil fuel consumption to run the diesel generators to feed the loads. In this case, the stored energy resource will act as one of the dispatchable generators in the system.

Generator Unit Commitment

This function of U90^{Plus} enables users to force select the dispatchable generators to be committed for a certain minimum time over the forecasted horizon with a minimum delay. This function considers a portion of the energy storage outputs defined by a predetermined profile - which is calculated by microgrid optimization algorithms based on readings from storage device and the results of previous optimal dispatch.

This function also enables use of grid connection as a resource and determines the total share of power to be imported from the grid to be able to support the load demand.

The Unit Commitment function of the U90^{Plus} feeds the Optimal Dispatch algorithm to commit certain generating assets considering system parameters and forecasted demand.

Generator Unit Commitment Integration

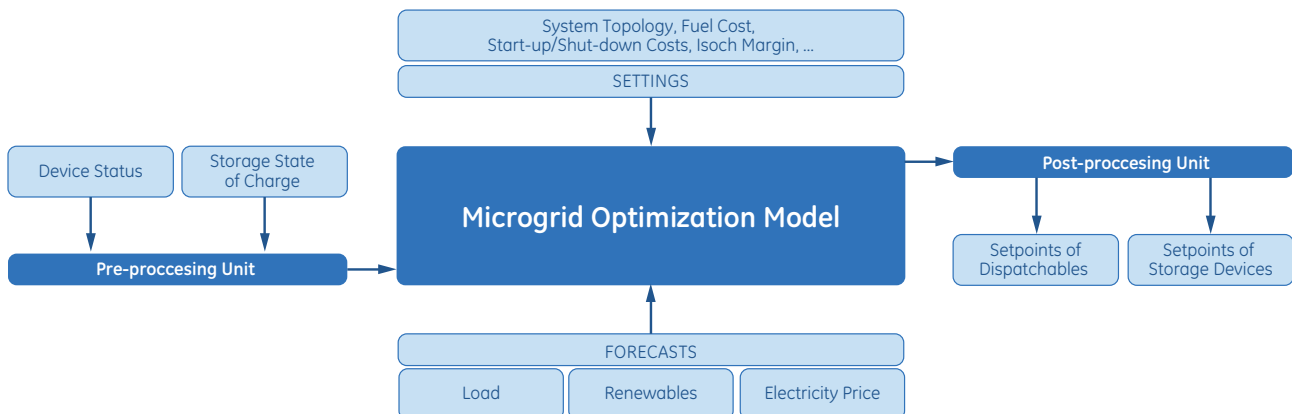

Automation Control

The U90^{plus} Generation Optimizer algorithms are able to make recommendations as to when to use the various dispatchable resources in the network. When appropriate, these commands can be sent directly to the local controllers that are connected to the generators.

When there are special requirements or operating conditions that need to first be considered before these commands can be sent to the local controllers, the U90^{plus} contains an advanced logic engine that can be used to customize the control of these resources. This logic engine includes many different types of logic operators including Boolean logic and mathematical operators.

For example, in cases where it is not possible to directly measure the hydrogen state of charge in a hydrogen based energy storage system, by using a mathematical equation value of hydrogen charge level it can be calculated locally using this powerful logic and math engine.

Communications

Modbus Master

The U90^{plus} Generation Optimizer uses the Modbus TCP/IP protocols and acts as a Modbus Master to communicate with the devices connected to the Generation and Load points. The U90^{plus} optimizes the amount of information needed and uses the low bandwidth required in the Modbus protocol so that the Microgrid optimization system can operate even where there is limited bandwidth between the U90^{plus} and the local control devices.

Modbus TCP/IP

Modbus TCP/IP protocols are supported in the U90^{plus} for the purpose of integration into SCADA or Energy Management Systems. Information that can be made available to these systems include:

- Real time load being used
- Total renewable generation being provided
- Total stored energy being provided
- Amount of stored energy available for use
- Total dispatchable generation available

Upstream System Communications

The D400 controller, as part of the MCS system, can act as a gateway device to be able to communicate to upstream utility systems on standard DNP 3.0 utility communications protocol. This functionality may be desired for grid tied microgrid systems.

Sequence of Events Record

The U90^{plus} provides a Sequence of Events Record that records all of the generation optimization decisions and logic operations performed by the U90^{plus}. The Sequence of Events can be monitored locally on the front panel HMI and can also be retrieved through the event file (event.txt) through the setup software.

Security

The U90^{plus} and associated software tools provide a suite of security features that ensure only authorized personnel can make changes to the configuration of the system.

Password Security

The U90^{plus} provides password security to ensure that only authorized personnel can change the settings in the U90^{plus}. There are four levels of password security provided:

- Local Settings Access
- Local Control Access
- Remote Settings Access
- Local Settings Access

Security Audit Trail

The U90^{plus} continually monitors itself to ensure the security of its configuration. The U90^{plus} offers complete traceability of any setting changes and commands given, allowing the user to quickly identify changes made to the device. A security file (security.txt) can be retrieved via the setup software from the U90^{plus}. This security file can help identify the time of sending the setting file and alarm configurations (for the annunciator) to the U90^{plus}.

Maximize the Distribution Network Efficiency (Grid Tied Networks)

The MCS system can also provide capability to minimize the distribution system losses and maximize network efficiency by leveraging the existing system assets such as Voltage regulators and capacitor banks. The Multilin D400 controller, as part of the MCS system, can host advanced algorithms for Volt/VAR controls for a distribution network.

It is possible to increase local distribution network efficiency by optimizing and flattening the voltage profile and by maximizing the reactive power injection into the local distribution network.

Microgrid Visualization and HMI

The Grid IQ MCS system offering includes a powerful, user-friendly HMI for monitoring, control and visualization of a Microgrid network.

GE's Proficy™ HMI, offered as a part of the Grid IQ MCS system, provides complete visualization, monitoring and control solution for a microgrid system. GE's Proficy HMI is a purpose built electric utility oriented system based on GE's market-leading, industry-standard SCADA software, CIMPPLICITY™. CIMPPLICITY is a well suited platform for both the permanently islanded (off-the-grid) and grid-connected Microgrid systems.

Typical Microgrid Applications

Islanded Mining and Remote Communities

One of the biggest challenges that permanently islanded remote and mining communities face is to reduce total cost of energy, primarily driven by fossil fuel cost and quite exorbitant fuel transportation costs. Although, many of these remote communities may have some form of a renewable resource, such as run of a river hydro, small bio-gas plant, wind, or solar, unfortunately because of lack of smart control system infrastructure, they are primarily dependent upon fossil fuel based generation for their energy needs.

The Grid IQ MCS system can help many of these remote islanded communities by optimizing the operation of existing assets and also by helping integrating renewable energy resources into the existing network. Such capability not only helps these communities to reduce the total cost of energy, but can also help reduce the GHG emissions and resulting adverse environmental impacts.

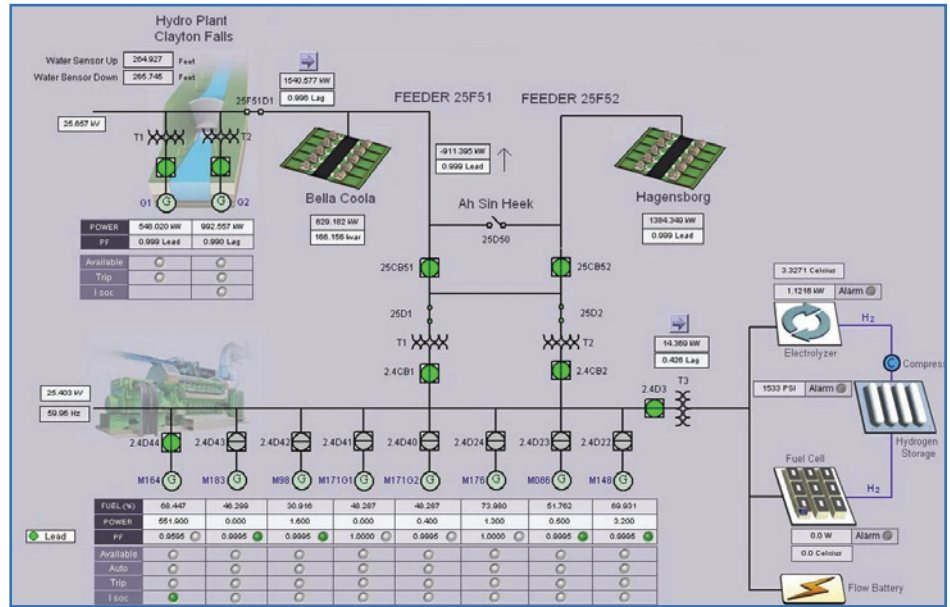

A microgrid system architecture diagram for a typical remote community suitable for application of GE's Grid IQ MCS system.

Grid Connected Military Bases

The defense departments across various parts of the world are up against critical challenges to sustain their mission critical infrastructure during an unplanned event. Their objective is to provide secure and reliable power to their critical infrastructure regardless of situation of the main grid. Although cost of energy and environmental impacts of fossil fuels are important considerations for them, their primary reason for exploring microgrids is to provide a safe, secure and reliable power network for their mission critical buildings and assets.

The MCS system can help many of these defense installations by providing a capability to operate in secure islanded mode in case the main grid has an unwanted interruption. The MCS can manage available backup power sources and storage devices, possibly in combination with demand side management for low priority loads to sustain mission critical infrastructure.

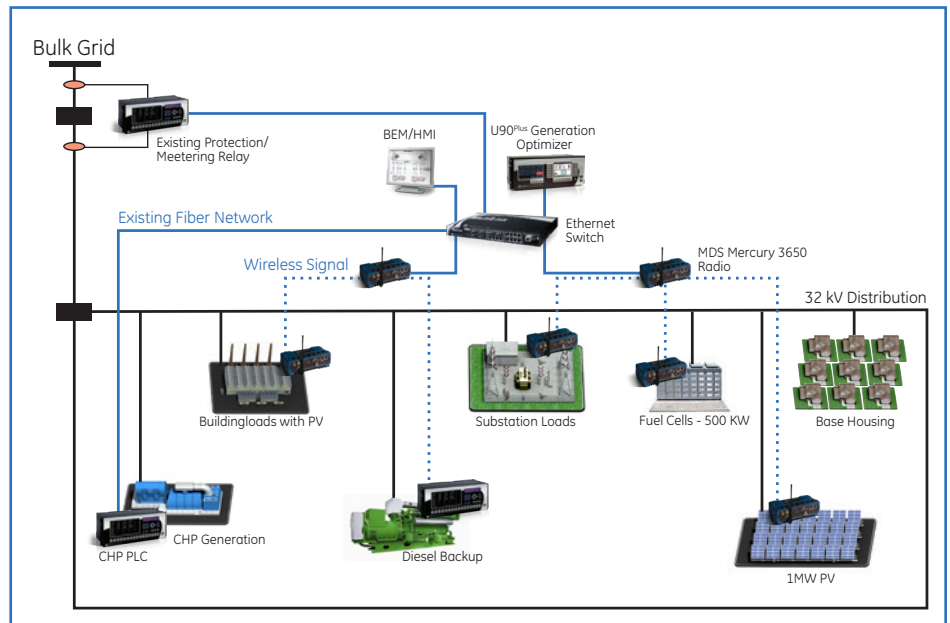

A microgrid system architecture diagram for a typical military base capable of operating in islanded mode in case of an adverse event on the main grid.

Digital Energy
650 Markland St.
Markham, ON
Canada L6C 0M1
Toll Free (NA Only): 1-800-547-8629
Tel: 905-927-7070
Fax: 905-927-5098



imagination at work

ecomagination™
Certified

GEDigitalEnergy.com

NERC is a registered trademark of the North American Electric Reliability Corporation.
GE, the GE monogram, Grid IQ, Multilin, EnerVista, Proficy and CIMPLICITY are trademarks of the General Electric Company.

GE reserves the right to make changes to specifications of products described at any time without notice and without obligation to notify any person of such changes.

© Copyright 2012, General Electric Company. All Rights Reserved.

GE's Grid IQ Microgrid Control System is "ecomagination approved" by GE. This means it has been proven to deliver significant operational and environmental benefits to customers. Ecomagination is GE's way of creating new value for customers, investors and society by helping to solve energy and efficiency challenges.