

# Multilin M60



## Comprehensive Protection for Medium to Large Motors

The Multilin™ M60 motor protection system offers comprehensive protection and control solutions for medium to large-sized three-phase motors. The M60 includes advanced automation and communication capabilities, extensive I/O options, and powerful fault recording features that can simplify postmortem fault analysis and help minimize motor downtime.

The M60 provides superior protection, control, and diagnostics that includes a proven thermal model with RTD and current unbalance biasing, stator differential, reverse and low forward power, external RRTD module, two-speed motors, reduced voltage starting, and broken rotor bar detection.

### Key Benefits

- Extended motor life with advanced protection and control elements including a flexible and powerful thermal model and standard, custom, and voltage dependent overload curves
- Integrated automation and process control functions eliminating the need for additional discrete devices
- Simplified setup and configuration with EnerVista M60 Motor Settings auto-configurator
- Enhanced motor-learned data provides critical information for preventative maintenance
- An integrated large, full color display, provides real-time visualization and control of the protected bay, via a bay mimic as well as annunciator functionality and graphical visualization of phasors
- Advanced IEC 61850 Ed. 1 and Ed. 2 certified implementation, complete settings via SCL files and comprehensive process bus support (IEC 61850-9-2LE or IEC 61869 or IEC 61850-9-2 Hardfiber) ensures interoperability, device managing optimization and reduced cost of ownership
- Routable GOOSE (R-GOOSE) enables customer to send GOOSE messages beyond the substation, which enables WAPC and more cost effective communication architectures for wide area applications
- Increased network availability via failover time reduced to zero through IEC® 62439-3 "PRP" support
- Supports IEEE C37.111-1999/2013, IEC 60255-24 Ed 2.0 COMTRADE standard

### Applications

- Protection & control of most popular construction type medium to large three-phase induction motors
- Protection of medium to large synchronous motors when paired with the SPM Synchronous Motor Protection System
- Automation or process control functionality
- Stand-alone protection or component in automated substation control system

## Protection and Control

- Enhanced thermal model with RTD and current unbalance compensation
- Stator Differential, Mechanical Jam/Stall, Short circuit tripping, under-Current & -Power and Phase reversal
- Two-speed motor protection and reduced voltage starting
- Optional internal RTDs & external RTD module
- Protection and control functionality in one box, reducing the number of devices
- High density inputs/outputs to support the control of many switchyard assets – all from one powerful device
- Integrated large, full color display, for real-time visualization and control of the protected bay

## Advanced Communications

- Support industry standard protocols with 3 independent Ethernet ports for simultaneous & dedicated connection with IEEE 1588 support
- DeviceNet and Profibus protocol support using D485 and P485 protocol converters
- IEC 61850-9-2LE/IEC 61869 networked or IEC61850-9-2 Hardfiber process bus support

## Cyber Security

- CyberSentry™ provides high-end cyber security aligned to industry standards and services (NERC® CIP, AAA, Radius, RBAC, Syslog)

## Monitoring & Metering

- Advanced recording capabilities with high-capacity event recorder, configurable and extended waveform capture and data logger
- Metering: current, voltage, power, energy, frequency, and harmonics



## Protection and Control

Designed as an asset management device, the M60 utilizes a proven thermal model that mimics the design characteristics of each motor it protects. As part of the Universal Relay (UR) family, the M60 provides the modularity, flexibility, and reliability required to deliver superior protection and control capabilities, including:

### Motor Thermal Model

The M60 features an enhanced motor thermal model consisting of the following elements:

- Thermal limit curves - NEMA standard, voltage dependent and customized
- IEC 60255-8 thermal overload curves
- Current unbalance biasing
- Independent running and stopped exponential cooling curves
- Optional RTD biasing of the thermal model to adapt to real-time temperature measurements
- Compensation for hot/cold motor conditions

The M60 thermal model integrates both stator and rotor heating and cooling into a single model.

### FlexCurves™

For applications that require greater flexibility, FlexCurves can be used to define custom curve shapes. These curves can be used to protect motors with different rotor and stator damage curves, allowing complete protection over the total motor capacity.

## M60 - Protection, Metering, Monitoring and Control

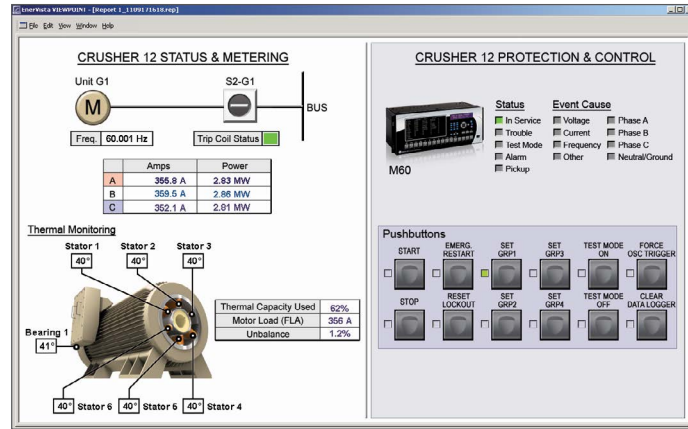

The M60 provides protection, control, metering, and monitoring in a single device, easily integrated into existing HMI or SCADA monitoring and control systems.

### Overtemperature Protection

The M60 supports up to 16 programmable RTD inputs that allow for the configuration of the alarm and trip temperature of each RTD, detecting RTD shorting conditions, and selecting RTD voting that requires more than one RTD to detect an over-temperature condition before it will issue a trip command.

### Mechanical Jam

The mechanical jam element senses increased loading associated with process or load related faults such as an overloaded conveyor. A programmable delay setting can be used to allow the process to attempt to clear itself before issuing a trip.

### Acceleration Time

The M60 protects the motor from overheating in cases of abnormal loading during motor starts. The motor can be tripped if the motor does not reach a running condition within the programmable motor acceleration time.

### Stator Differential

The M60 provides stator differential protection for fast clearing of stator phase faults. Advanced CT saturation detection algorithms and dual-slope characteristics are incorporated for increased security during heavy faults.

## Functional Block Diagram

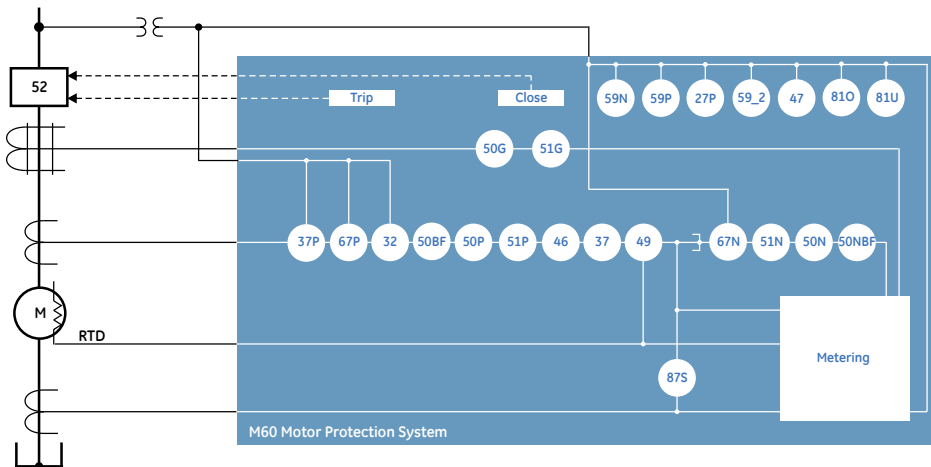

## ANSI® Device Numbers & Functions

DEVICE NUMBER	FUNCTION
27P	Phase Undervoltage
27X	Auxiliary Undervoltage
32	Sensitive Directional Power
37	Undercurrent
37P	Underpower
46	Current Unbalance
47	Phase Sequence Voltage
49	Thermal Model
50BF	Breaker Failure
50G	Ground Instantaneous Overcurrent
50N	Neutral Instantaneous Overcurrent
50P	Phase Instantaneous Overcurrent
51G	Ground Time Overcurrent
51N	Neutral Time Overcurrent
51P	Phase Time Overcurrent
59N	Neutral Overvoltage
59P	Phase Overvoltage
59X	Auxiliary Overvoltage
59_2	Negative Sequence Overvoltage
66	Starts Per Hour, Time Between Starts
67N	Neutral Directional Overcurrent
67P	Phase Directional Overcurrent
81O	Overfrequency
81U	Underfrequency
87S	Stator Differential
---	Mechanical Jam

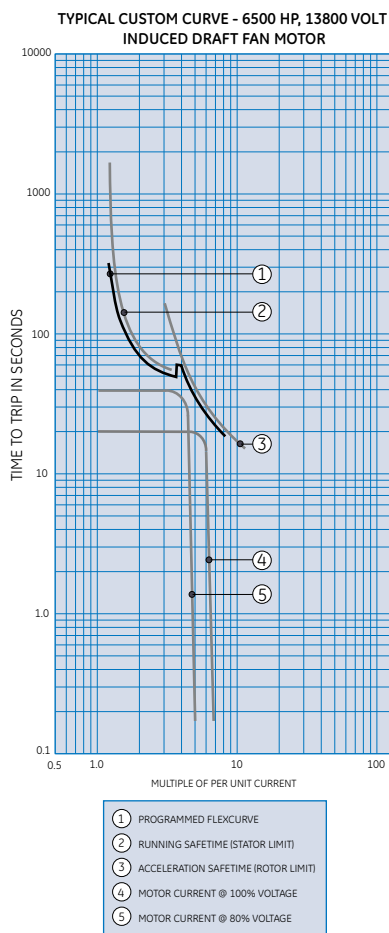

Typical FlexCurve overload curve.

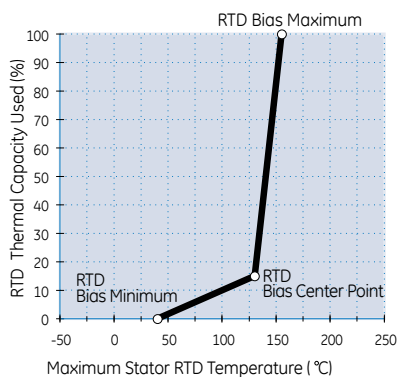

RTD bias curve.

### Short Circuit Protection

Short circuit overcurrent protection protects damage to the motor during a locked rotor condition. The M60 comes with up to 8 instantaneous overcurrent elements that can be configured for protection, alarming, and control during locked rotor conditions.

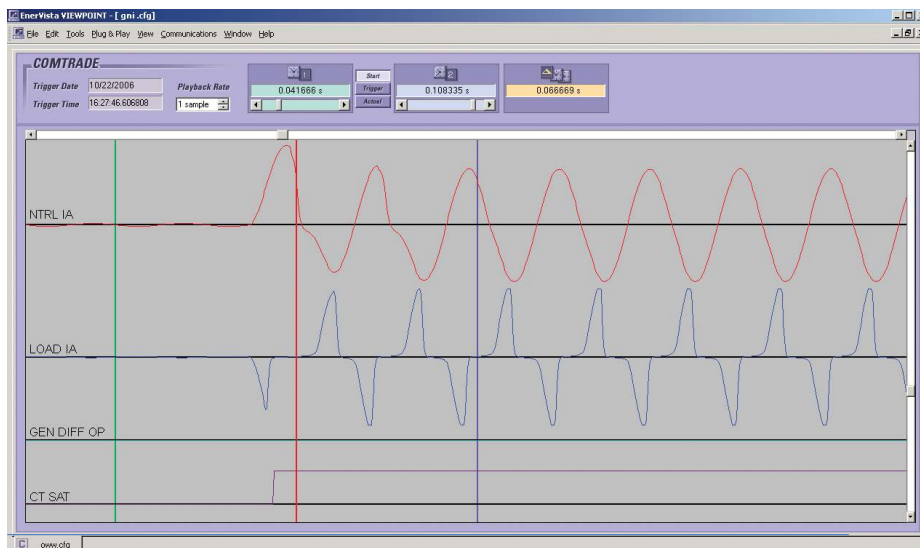

The M60 percent differential element has enhanced saturation detection algorithms to provide additional security against AC and DC saturation that can occur during faults near the motor.

### Start Inhibit

The start inhibit function prevents the starting of a motor when the motor is too hot and does not have a sufficient amount of thermal capacity available to allow a start without being tripped offline.

### Breaker Failure Protection

The breaker failure protection element monitors for timely operation of the connected breaker. If a trip command is not successful in operating the breaker and clearing the fault, the breaker failure element can be used to send trip signals to upstream breakers to clear the fault.

### Undercurrent Protection

The undercurrent protection element provides the ability to trip the motor due to external conditions that can cause the load being pulled by the motor to drop below a preset level. This element is useful when the loss of the load results in a loss of cooling which will cause the asset to overheat.

### Under/Over Frequency Protection

The under/over frequency protection element detects when the motor is operating at off-nominal frequencies (which can damage the process) or signals to upstream protection or control to implement load-shedding actions.

### RTD Protection (Module Option 5C)

The M60 RTD option provides 8 programmable RTD inputs per module that are used for monitoring the stator, bearing and ambient

temperatures. Each RTD input has 2 operational levels: alarm and trip. The M60 supports RTD trip voting and provides open RTD failure alarming. Alternatively, a remote RTD module “RRTD”, which supports 12 RTD inputs, can also be used with the M60 for temperature monitoring. The RRTD provides cost savings compared with standard RTD wiring.

### Two-Speed Motor Protection

The two-speed motor protection feature allows for the protection of motors that can operate at two different speeds and have different full load capacity levels at each speed. This feature can be used on motors that have two sets of windings on each stator, where each set is used to operate the motor at a different speed.

### Underpower Protection

The underpower protection feature provides for sensitive detection of a loss of load condition. The underpower protection element can be more sensitive for detecting loss of load conditions caused by process-related problems than is possible using a standard undercurrent element.

### Reduced Voltage Starting

The reduced voltage starting feature provides the controls for signaling the motor to switch over from a reduced voltage (that is used during startup) to the full voltage for motor running operation. This feature can issue the command to switch to full operating voltage, by detecting: a) if the motor load has reached a preset current level, or b) if a time delay has elapsed (after starting), or c) both of these conditions combined.

## IEC 61869 and 61850-9-2LE Process Bus

Three UR process bus modules enable communicating to Merging Units “MU” that comply to either IEC 61869 standard or IEC 61850-9-2LE technical report. MUs connect to the primary asset and translate analog signals and digital status/commands to standard sample values “SV” data and GOOSE messages.

Flexibility for connecting to different network size and topology is granted through 100Mbps and/or 1Gbps Ethernet port support, plus IEC 62439 PRP or HSR standard redundancy, plus Star, Ring and Point-to-point network support.

For time synchronization purposes, this Process bus module can become an IEEE 1588 slave clock (61850-9-3 profile) or a 1588 Grand Master clock which removes the need of external time sources connected to the process bus network.

Customers who may not be using GE MU devices, could use MU from other vendors. Interoperability with MU from other vendors is expected when they comply to the mentioned standards.

## IEC 61850-9-2 HardFiber Process Bus

The IEC 61850 Process Bus module is designed to interface with the Multilin HardFiber System, allowing bi-directional IEC 61850 fiber optic communications. The HardFiber System is designed to integrate seamlessly with existing UR applications, including protection functions, FlexLogic™, metering and communications. The Multilin HardFiber System offers the following benefits:

- Communicates using open standard IEC 61850 messaging
- Drastically reduces P&C design, installation and testing labor by eliminating individual copper terminations
- Integrates with existing M60's by replacing traditional CT/VT inputs with the IEC 61850 Process Bus module
- Does not introduce new cyber security concerns

Visit the HardFiber System product page on the GE Grid Solutions web site for more details.

## Advanced Automation

The M60 incorporates advanced automation features including powerful FlexLogic programmable logic, communication, and

### Topologies:

PRP Start  
Hot-Stanby

### Topologies:

HSR ring  
PRP start  
P-2-P Process Bus

Merging units

Conventional or Optical CT/VTs

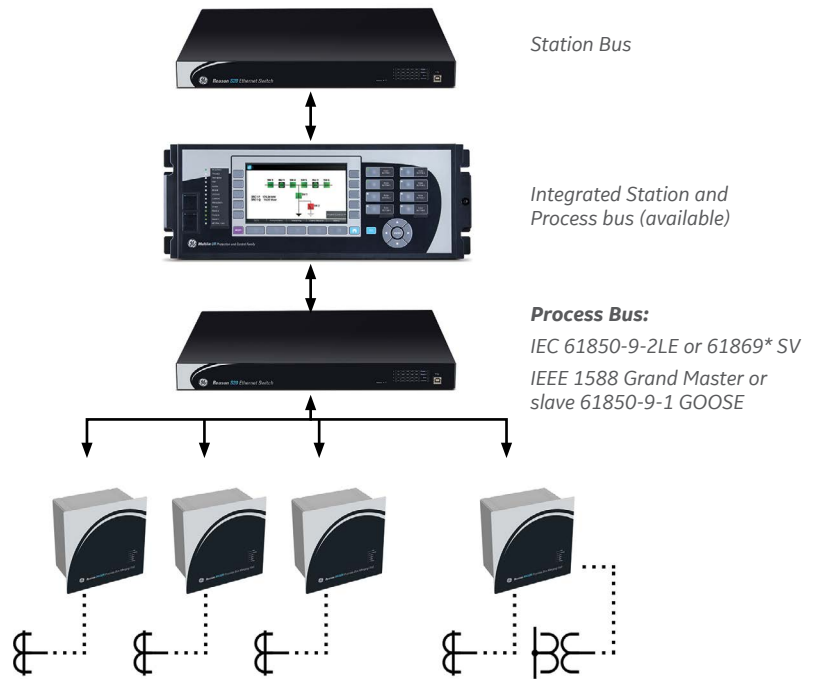

SCADA capabilities that far surpass what is found in the average motor protection relay. The M60 integrates seamlessly with other UR relays for complete system protection, including the adjacent motors, feeders and other balance of plant protection.

### FlexLogic

FlexLogic is the powerful UR-platform programming logic engine that provides the ability to create customized protection and control schemes, minimizing the need and associated costs of auxiliary components and wiring. With 1024 lines of FlexLogic, the M60 can be programmed to provide the required tripping logic along with custom scheme logic for motor breaker control (including interlocking with internal motor start supervision and synchrocheck), interlocking schemes with adjacent protections (for example, preventing sympathetic tripping of healthy feeders), and dynamic setting group changes.

### Scalable Hardware

The M60 is available with a multitude of I/O configurations to suit the most demanding application needs. The expandable modular design allows for easy configuration and future upgrades.

- Multiple CT/VT configurations allow for the implementation of many protection schemes, including applications with high-impedance machine grounding

- RTD inputs allow biasing of the motor thermal model, as well as overtemperature protection of the stator, bearings, and other heat-sensitive components of the motor
- Types of digital outputs include tripped Form-A and Solid State Relay (SSR) mechanically latching, and Form-C outputs
- DCmA inputs are available to monitor equipment and process parameters

## Monitoring and Metering

The M60 includes high accuracy metering and recording for all AC signals. Voltage, current, and power metering are built into the relay as a standard feature. Current and voltage parameters are available as total RMS magnitude, and as fundamental frequency magnitude and angle.

### Advanced Device Health Diagnostics

The M60 performs advanced motor health diagnostics and records this information for each of the last 250 consecutive motor starts. Analyzing this diagnostic information for operating parameters that have changed over these successive starts can indicate maintenance requirements before damage occurs and costly repairs are required



For each motor start, the M60 will provide a record that contains the following information:

- Date of each motor start
- Motor acceleration time
- Motor starting current
- Motor thermal capacity used during starts
- Average motor load
- Running time after a start

### Advanced Motor Diagnostics

The Multilin M60 provides advanced motor diagnostics including a broken rotor bar detection function. The broken rotor bar detection is a condition maintenance function that continuously monitors the motor's health while in operation. The advanced Motor Current Signature Analysis (MCSA) continuously analyzes the motor current signature and based on preset algorithms, will determine when a broken rotor bar is present in the motor. With fully programmable alarms, the broken rotor bar function will provide early detection of any rotor problems and advise maintenance personnel of the impending issue, allowing for predictive maintenance of the motor and prevention of catastrophic motor failures.

By providing early indication of potential rotor problems, serious system issues, such as reduced starting torque, overloads, torque and speed

oscillation and bearing wear, can be avoided. With the advanced broken rotor bar detection system, advanced warning of impending problems reduces catastrophic failures, maximizing motor life and system uptime.

### Fault and Disturbance Recording

The advanced disturbance and event recording features within the M60 can significantly reduce the time needed for postmortem analysis of power system events and the creation of regulatory reports. Recording functions include:

- Sequence of Event (SOE)
  - 1024 time stamped events
- Oscillography
  - Supports IEEE C37.111-1999/2013, IEC 60255-24 Ed 2.0 COMTRADE standard
  - 128 digital & up to 56 analog channels
  - Events up to 45s in length
- Data Logger and Disturbance Recording
  - 16 channels up to 1 sample/cycle/channel

The very high sampling rates and the large amount of storage space available for data recording in the M60 can eliminate the need for installing costly stand-alone recording equipment.

### Cyber Security – CyberSentry UR

CyberSentry™ is a software option that delivers wide range of cyber security features that help customers to comply with NERC CIP, NIST® IR

7628, IEC 62351 and IEC 62443 cyber security requirements and standards. Additionally secure FW upgrade is granted through UR Setup's digital signature validation capabilities.

This software option delivers the following core features:

### AAA Server Support (Radius/LDAP)

Enables integration with centrally managed authentication and accounting of all user activities and uses modern industry best practices and standards that meet and exceed NERC CIP requirements for authentication and password management.

### Role Based Access Control (RBAC)

Efficiently administrate users and roles within UR devices. The new and advanced access functions allow users to configure up to five roles for up to eight configurable users with independent passwords. The standard "Remote Authentication Dial In User Service" (Radius) is used for authentication.

### Event Recorder (Syslog for SEM)

Capture all cyber security related events within a SOE element (login, logout, invalid password attempts, remote/local access, user in session, settings change, FW update, etc), and then serve and classify data by security level using standard Syslog data format. This will enable integration with established SEM (Security Event Management) systems.

## Power System Troubleshooting

The M60 contains many tools and reports that simplify and reduce the amount of time required for troubleshooting power system events.

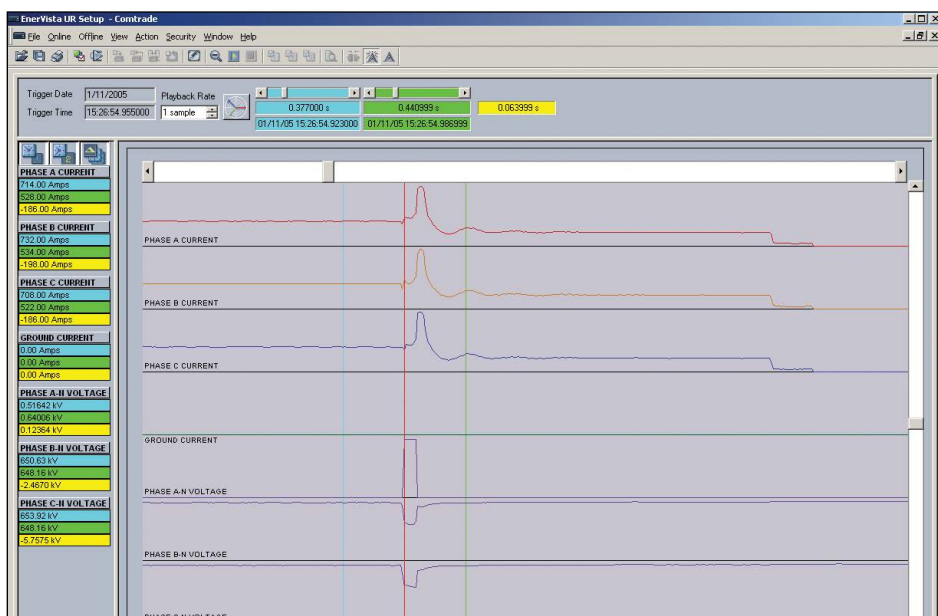

Analyze motor operating characteristics by recording analog waveforms during system voltage recovery.

The M60 supports the most popular industry standard protocols enabling easy, direct integration into DCS and SCADA systems.

- IEC 61850 Ed. 1 and Ed. 2 Station Bus, IEC 61850-2-2LE / IEC 61869 networked or IEC 61850-9-2 HardFiber Process Bus
- DNP 3.0 (serial & TCP/IP)
- Ethernet Global Data (EGD)
- IEC 60870-5-103 and IEC 60870-5-104
- Modbus RTU, Modbus TCP/IP
- HTTP, TFTP, SFTP and MMS file transfer
- IEEE 1588 and redundant SNTP for time synchronization
- PRP as per IEC 62439-3
- IEC61850 GOOSE, Routable GOOSE and legacy UCA fixed GOOSE

**Interoperability with Embedded IEC 61850 Ed. 1 and Ed. 2**

The new IEC 61850 implementation in the UR Family positions GE as an industry leader in this standard.

- Implements, user selectable, Ed. 1 and Ed. 2 of the standard across the entire UR Family
- Provides full relay setting management via standard SCL files (ICD, CID and IID)
- Enables automated relay setting management using 3rd party tools through standard file transfer services (MMS and SFTP)
- Increases the number of Logical Devices and data mapped to them, GOOSE messages from up to 64 remote devices, and reports to support different organizational needs for data transfer and reduce dependency on generic logical nodes
- Configures GE Systems based on IEC 61850 using universal 3rd party tools
- R-GOOSE enable customer to send GOOSE messages beyond the substation, which enables WAPC and more cost effective communication architectures for wide area applications

**Direct I/O Messaging**

Direct I/O allows for the sharing of high-speed digital information between multiple UR relays via direct back-to-back connections or multiplexed through a standard DS0 multiplexer channel bank. Regardless of the connection method, direct I/O provides continuous real-time channel monitoring that supplies diagnostics information on channel health.

Direct I/O provides superior relay-to-relay communications that can be used in advanced interlocking and blocking schemes.

- Communication with up to 16 UR relays in single or redundant rings rather than simplistic point-to-point configurations
- Connect to standard DS0 channel banks through standard RS422, G.703 or IEEE C37.94 interfaces or via direct fiber optic connections
- Built-in continuous loop and channel monitoring provides real-time diagnostics of your communication channels with no external or handheld tester required

**LAN Redundancy**

Substation LAN redundancy has been traditionally accomplished by reconfiguring the active network topology in case of failure. Regardless of the type of LAN architecture (tree, mesh, etc), reconfiguring the active LAN requires time to switchover, during which the LAN is unavailable. UR devices deliver redundancy as specified by PRP-IEC 62439-3, which eliminates the dependency on LAN reconfiguration and the associated switchover time. The UR becomes a dual attached node that transmits data packets over both main and redundant networks simultaneously, so in case of failure, one of the data packets will reach the receiving device with no time delay.

**Multi-Language**

UR devices support multiple languages: English, French, Russian, Chinese, Turkish, German, Polish and Japanese. These language options are available on the front panel, in the EnerVista

setup software, and in the product manuals. Easily switch between English and an additional language on the local displays without uploading new firmware.

**EnerVista Software**

The EnerVista suite is an industry-leading set of software programs that simplifies every aspect of using the M60 relay. The EnerVista suite provides all the tools to monitor the status of your motor, maintain your relay, and integrate information measured by the M60 into DCS or SCADA monitoring systems. Convenient COMTRADE and SOE viewers are an integral part of the UR setup software included with every UR relay, to carry out postmortem event analysis and ensure proper protection system operation. UR Setup also provides an export/import setting file tool which allows customer to transfer specific settings from one file to another. This tool also provides comprehensive setting file comparison. These features, together with UR single setting file, help users to simplify their setting file management experience.

**EnerVista Launchpad**

EnerVista Launchpad is a powerful software package that provides users with all of the setup and support tools needed for configuring and maintaining Multilin products. The setup software within Launchpad allows for the configuration of devices in real-time by communicating using serial, Ethernet, or modem

**Simplifying Commissioning and Testing**

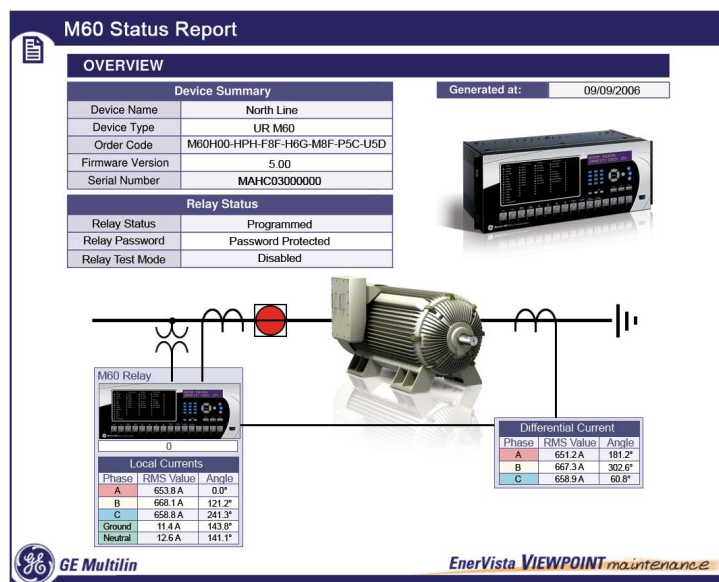

The internal operation of the M60 elements, logic, and outputs can be monitored in real-time to simplify commissioning and troubleshooting procedures.

connections, or offline by creating setting files to be sent to devices at a later time.

Included in Launchpad is a document archiving and management system that ensures critical documentation is up-to-date and available when needed. Documents made available include:

- Manuals
- Application Notes
- Guideform Specifications
- Brochures
- Wiring Diagrams
- FAQs
- Service Bulletins

The UR setup software now contains an M60 Motor Setting Auto-Configurator that configures all of the settings required to protect and control a motor in six simple steps. Simply entering the motor nameplate data, the CT and VT parameters, motor starting data, and application information, will allow the UR setup software to generate a complete setting file customized for protecting and controlling the motor.

### Viewpoint Monitoring

Viewpoint Monitoring is a simple-to-use and full-featured monitoring and data recording software package for small systems. Viewpoint Monitoring provides a complete HMI package with the following functionality:

- Plug & Play Device Monitoring
- System Single-Line Monitoring & Control
- Annunciator Alarm Screens
- Trending Reports
- Automatic Event Retrieval
- Automatic Waveform Retrieval

## User Interface

The M60 front panel provides extensive local HMI capabilities. The local display is used for monitoring, status messaging, fault diagnosis, and device configuration. User-configurable messages that combine text with live data can be displayed when user-defined conditions are met.

A 7" color, graphic HMI is optionally available that allows users to have customizable bay diagrams with local monitoring of status, values and control functionality. The alarm annunciator panel provides the configuration of up to 96 signals (alarms and status) with full text description.

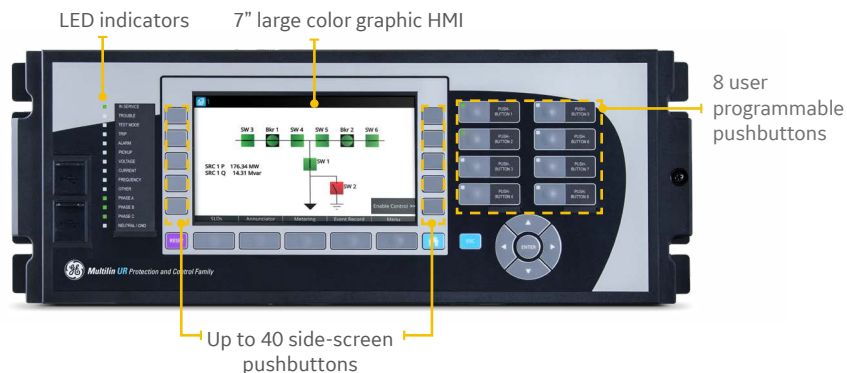

Typical Wiring

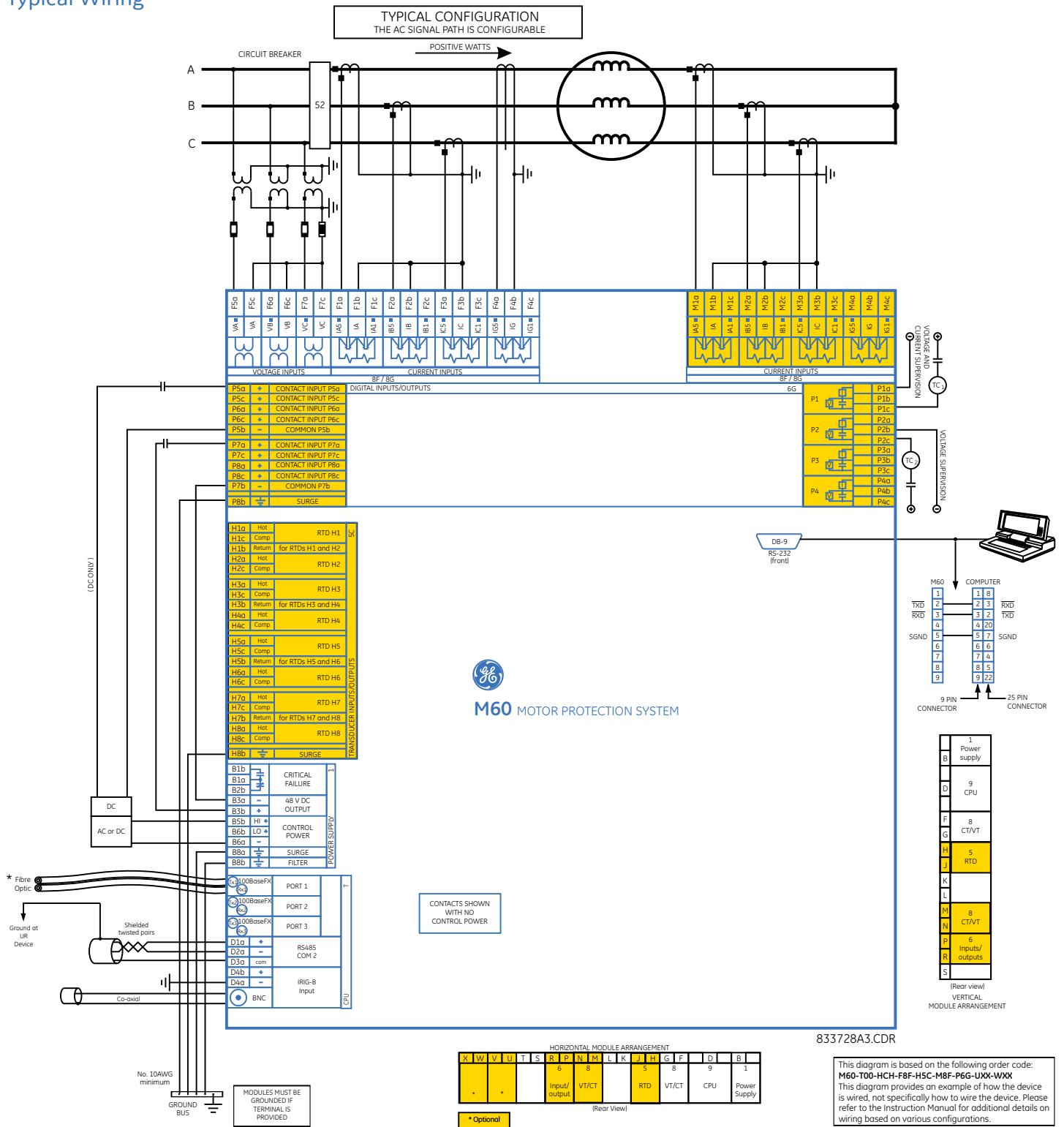



# Ordering

	M60	*	00	-	H	*	*	-	F	**	-	H	**	-	M	**	-	P	**	-	U	**	-	W/X**		
Base Unit	M60																								For full sized horizontal mount	
CPU		T	U	V	W																				Base Unit RS485 + three multimode SFP LC 100BaseFX RS485 + two multimode SFP LC 100BaseFX + one SFP RJ45 100BaseT RS485 + three SFP RJ45 100BaseT RS485 + two 100BaseFx Eth, Multimode ST + one 10/100BaseT Eth, RJ-45 <sup>3</sup>	
Software Options <sup>1</sup>			00	03	A0	B0	C0	D0																	No Software Options IEC 61850 CyberSentry UR Lvl 1 IEEE 1588 PRP	
Mount / Coating						H	A	V	B																IEEE 1588 + CyberSentry UR Horizontal (19" rack) - Standard Horizontal (19" rack) - Harsh Chemical Environment Option Vertical (3/4 size) - Standard Vertical (3/4 size) - Harsh Chemical Environment Option	
User Interface						E	F	J	K	L	M	N	O	T	U	V	W	Y	H	O	Z	X				7" Graphical display, USB front port & programmable pushbuttons - Multi-Language (FW 7.6x or higher) Vertical Front Panel with English Display Enhanced German Front Panel Enhanced German Front Panel with User-Programmable Pushbuttons Enhanced English Front Panel Enhanced English Front Panel with User-Programmable Pushbuttons Enhanced French Front Panel Enhanced French Front Panel with User-Programmable Pushbuttons Enhanced Russian Front Panel Enhanced Russian Front Panel with User-Programmable Pushbuttons Enhanced Chinese Front Panel Enhanced Chinese Front Panel with User-Programmable Pushbuttons Enhanced Turkish Front Panel Enhanced Turkish Front Panel with User-Programmable Pushbuttons Enhanced Polish Front Panel <sup>3</sup> Enhanced Polish Front Panel with User-Programmable Pushbuttons <sup>3</sup> Enhanced Japanese Front Panel <sup>3</sup> Enhanced Japanese Front Panel with User-Programmable Pushbuttons <sup>3</sup>
Power Supply <sup>2</sup>						H	L	L																	RH RL	125 / 250 V AC/DC 125 / 250 V AC/DC with redundant 125/250 V AC/DC 24 - 48 V (DC only) 24 - 48 V (DC only) with redundant 24 - 48 V (DC only)
CT/VT DSP									8L	8M	8N	8R			8L	8M	8N	8R								Standard 4CT/4VT w/ enhanced diagnostics Sensitive Ground 4CT/4VT w/ enhanced diagnostics Standard 8CT w/ enhanced diagnostics Sensitive Ground 8CT w/ enhanced diagnostics
IEC 61850 Process Bus <sup>4,5</sup>													81													8 Port IEC 61850 Process Bus Module -9-2LE & 61869 Process Bus, 2 x 100BaseF -9-2LE & 61869 Process Bus, 4 x 100BaseF + 4 x 100BaseFx -9-2LE & 61869 Process Bus, 4 x 100BaseFx
Digital I/O														XX	XX	XX	XX									No module 4 Solid State (No Monitoring) MOSFET Outputs 4 Solid State (Current w/opt Voltage) MOSFET Outputs 16 Digital Inputs with Auto-Burnish 14 Form-A (No Monitoring) Latchable Outputs 8 Form-A (No Monitoring) Outputs 8 Form-C Outputs 16 Digital Inputs 4 Form-C Outputs, 8 Digital Inputs 8 Fast Form-C Outputs 4 Form-C & 4 Fast Form-C Outputs 2 Form-A (Current w/ opt Voltage) & 2 Form-C Outputs, 8 Digital Inputs 2 Form-A (Current w/ opt Voltage) & 4 Form-C Outputs, 4 Digital Inputs 4 Form-A (Current w/ opt Voltage) Outputs, 8 Digital Inputs 6 Form-A (Current w/ opt Voltage) Outputs, 4 Digital Inputs 2 Form-A (No Monitoring) & 2 Form-C Outputs, 8 Digital Inputs 2 Form-A (No Monitoring) & 4 Form-C Outputs, 4 Digital Inputs 4 Form-A (No Monitoring) Outputs, 8 Digital Inputs 6 Form-A (No Monitoring) Outputs, 4 Digital Inputs 2 Form-A (Cur w/ opt Volt) 1 Form-C Output, 2 Latching Outputs, 8 Digital Inputs 30 Contact Inputs - Pin Terminals <sup>3</sup> 18 Form-A (No Monitoring) Outputs - Pin Terminals <sup>3</sup>
Transducer I/O																										8 RTD Inputs 4 dcmA inputs, 4 RTD Inputs 8 dcmA inputs
Inter-Relay Communications																										7B 1300 nm, multimode, LED, 1 Channel 7H 820 nm, multimode, LED, 2 Channels 7I 1300 nm, multimode, LED, 2 Channels

### Ordering Notes:

- To view all available model order codes, options for M60 or to order the UR Classic Front Panel, please visit GE's On-Line Store at <http://store.gedigitalenergy.com/viewprod.asp?model=M60>
- Redundant power supply only available in horizontal unit. If redundant is chosen, must be same type. Maximum 2 per chassis
- Option available soon
- Process bus module requires empty slots next to it.
- Conventional DSP and Process Bus modules cannot run simultaneously

## GEGridSolutions.com

IEC is a registered trademark of Commission Electrotechnique Internationale. IEEE is a registered trademark of the Institute of Electrical Electronics Engineers, Inc. Modbus is a registered trademark of Schneider Automation. NERC is a registered trademark of North American Electric Reliability Council. NIST is a registered trademark of the National Institute of Standards and Technology.

GE, the GE monogram, Multilin, FlexLogic, EnerVista and CyberSentry are trademarks of General Electric Company.

GE reserves the right to make changes to specifications of products described at any time without notice and without obligation to notify any person of such changes.

Copyright 2023, General Electric Company. All Rights Reserved.

GEA-12756L(EN)  
English  
230413

