



Hinged armature auxiliary relay to perform auxiliary functions in AC and DC circuits.

Features and Benefits

- Molded case with 4 mounting options
- Drawout case available

Applications

- Contact multiplication

Protection and Control

- Standard, low and variable time pickup available
- AC undervoltage (low dropout)



Applications

The HGA hinged armature auxiliary relays are designed to provide additional contacts, higher contact carrying and interrupting ratings, timing, interlocking, electrical separation, or other auxiliary functions.

Where more than two circuits are to be controlled, the coils of two or more relays may be connected either in parallel on AC or in series or parallel on DC to obtain the desired results.

General-Purpose Relays

Standard Pickup: The HGA11 is the standard auxiliary relay which is instantaneous in operation and is used for auxiliary functions where intentional delays of over 1-1/4 to 2 cycles are not required and where standard pickup values, as listed in the table, are satisfactory.

The contact arrangement for each relay (or unit) is double-pole, double-throw (2 normally open, 2 normally closed).

Low Pick-up: The HGA14 relay has been designed with a shorter armature gap which is obtained by the setting of an adjustable back contact. This construction allows a lower pickup value than normal and a faster pickup time. Also, relays are available for tripping duty and target operation with pickup times of 1/2 cycle on a 60-cycle basis, and are intermittently rated.

The contact arrangement is one single-pole, double-throw contact and one normally open contact for each relay (or unit). The second normally closed contact is not used with the low pickup setting. This second contact can be used if the wipe is restored to normal and the control spring tension increased thus raising the pickup toward the 80 percent (60 percent DC cold) level which would apply with standard gap

relays.

AC Undervoltage

Low Dropout. The HGA14BH(-)A relay is a three-phase residual voltage relay with low dropout. A primary application is as on automatic throwover schemes where induction motors are the principal load.

Time-Delay Relays

Fixed-time Dropout. The HGA17 is designed to provide a time-delay dropout of approximately 15 cycles (60-cycle basis). The delay is obtained by momentarily sustaining the magnetic flux at the relay pole face by means of induced currents in a copper ring which acts as a shorted one-turn coil. A small delay in pickup time is also obtained since the induced currents also tend to retard the buildup of the relay magnetic field. Operating times are measured at or from rated voltage or amperes for pickup and dropout times respectively.

Adjustable-time Pickup: The HGA14D has a resistor-capacitor timing circuit with the resistor being adjustable to vary the charging time of the capacitor which is connected across the relay operating coil.

Contact arrangement for the fixed-time dropout (HGA17) is one single-pole, double-throw contact and one normally open contact per relay (or unit).

Relay Characteristics

Voltage or Current Pickup Values. The values listed in the table below apply as indicated for all relays.

Contact Ratings

Standard Pickup Relays - HGA11

The current-closing rating of the contacts is 30 A. The current-carrying rating is 12 A continuously or 30 A for one minute.

Interrupting Ratings of Contacts in Amperes

Contact-circuit		Single Break	Double Break
VAC	VDC		

NONINDUCTIVE CIRCUITS

---	6-32	15	30
---	48	8	16
---	125	2	3
---	250	0.3	0.4
115	---	30	30
230	---	20	30

INDUCTIVE CIRCUITS

---	6-32	5	10
---	48	3	6
---	125	1	1.5
---	250	0.25	0.3
115	---	10	20
230	---	6	10

Low Pickup Relays — HGA14, HGA17

The current closing ratings of the contacts is 30 A. The current carrying rating is 12 A continuously or 30 A for one minute. The interrupting ratings (noninductive circuits) for the various voltages are as follows:

Contact-circuit		Single Break
VAC	VDC	

NONINDUCTIVE CIRCUITS

---	6-32	10
---	48	5
---	125	0.6
---	250	0.25
115	---	20
230	---	10

INDUCTIVE CIRCUITS

---	6-32	5
---	48	3
---	125	0.5
---	250	0.2
115	---	10
230	---	5

Relay	Pickup Classification	Percentage of Rated V or A			
		Pickup Value		Dropout Value	
		AC	DC	AC	DC
HGA 11	Standard	80%	80%	40-50%	2-10%
HGA14	Low	40%	30%	20-30%	2-10%
HGA17A,B,C	Time	30-40%	20-30%	2-10%	2-10%
HGA17D,H	Time	80% Max.	60% Max.	5-15%	2-10%

BC surface mounting with cover

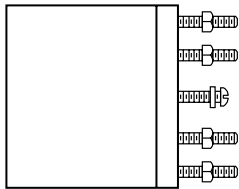

BC semi-flush mounting with cover

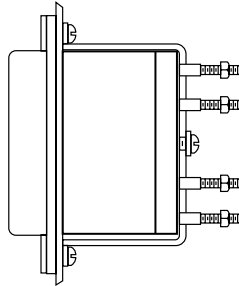

FC surface mounting with cover

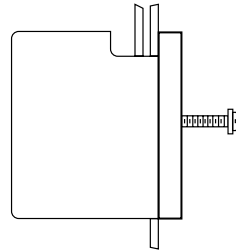

FC surface mounting with cover with provisions for front mounting

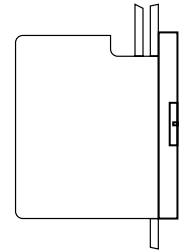

HGA11 Order Code Breakdown

Standard Pickup

HGA11	*	**	*	
A				Surface mounted back connected with studs and solid cover
J				Surface mounted front connected with solid cover
S				Surface mounted front connected with solid cover and provision for front mounted
	XX			Electrical data (see Group column under Selection guide)
Mounting options				
	F			Semi-flush mounted back connected with studs and cover with glass window
	G			Cover with glass window is required

Selection Guide

Group	DC Volt.	AC 50 Hz	AC 60 Hz	Contact	Pickup Time (cycles)	DC Res. Ohms @ 25°C	AC Res. Ohms	Approx. Wt. in lbs (kg)	
								Net	Ship
51	250					15500			
52	125					3650			
53	62.5					830			
54	48					512			
55	32					250			
56	24					160			
57	12			2 N.O. 2 N.C.	Approx 2	40		2	3
58	6					10		(0.9)	(1.4)
59	220					9600			
60	110					2460			
70			115				1000		
71			230				3960		
74		115					830		
75		230					4270		

Order Code Breakdown

HGA	***	****	
11N			Standard pickup general purpose double unit
11R			Standard pickup general purpose single unit
14A			Low pickup general purpose single unit
14AB			Low pickup general purpose double unit
14B4			Single short gap unit with rectifiers (60 cycles, low burden)
17J			Low pickup time delay single unit, fixed time (15 cycles min. dropout) (copper slugged coil)
	XXXX		Electrical data (see Group column under Selection guide)

Selection Guide

Drawout Case Relays

Pickup Option	Group	DC Volt.	VAC 50 Hz	VAC 60 Hz	Each Unit			Pickup Time (cycles)	Case	Approx. Wt. in lbs (kg)	
					DC Ohms @25°C	AC Z	Contact			Net	Ship
11N	1A	24			160						
11N	32A	48			512						
11N	63A	62.5			830						
11N	94A	125			3650						
11N	125A	250			15550						
11N	156A			115		90	①	2	S2	9 (4.1)	11 (5)
11N	187A		115			99					
11N	249A			230		376					
11N	280A		230			512					
11N	342A	6			10						
11N	373A	12			40						
11R	1A	24			160						
11R	2A	48			512						
11R	3A	62.5			830						
11R	4A	125			3650						
11R	5A	250			15550						
11R	6A			115		90	①	2	S1	7 (3.2)	9 (4.1)
11R	7A		115			99					
11R	9A			230		512					
11R	10A		230			512					
11R	15A	6			10						
11R	16A	12			40						
14A	1A	24			160						
14A	2A	48			512						
14A	3A	62.5			830						
14A	4A	125			3650						
14A	5A	250			15550						
14A	6A			115		90		1	S1	7 (3.2)	9 (4.1)
14A	7A		115			99					
14A	9A			230		512					
14A	10A		230			512					
14A	15A	6			10						
14A	16A	220			9600						
14AB	1A	24			160						
14AB	32A	48			512						
14AB	63A	62.5			830						
14AB	94A	125			3650						
14AB	125A	250			15550						
14AB	156A			115		90			S2	9 (4.1)	11 (5)
14AB	187A		115			99					
14AB	249A			230		376					
14AB	280A		230			512					
14AB	342A	12			40						
17J	1A	12			25						
	2A	24			98						
	3A	32			153						
	4A	48			375						
	5A	62.5			585			2	S1	9 (4.1)	11 (5)
	6A	125			2280						
	7A	250			10300						
	10A		115	115		1700					

①HGA11 (standard pickup) double pole, double throw (2 normally open/two normally closed) per unit.

HGA14 (low pickup) one single pole, double throw. HGA17 (time delay) plus one normally open contact per unit.

HGA14 order Code Breakdown

Adjustable Time Delay on Pickup

HGA14	*	*	
	D		Back connected with cover
	X		Electrical data (see Group column under Selection guide)

Selection Guide

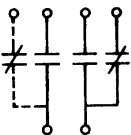
Group	DC Volt.	Pickup Volts	Contact	Pickup Time (cycles)	Approx. Wt. in lbs (kg)	
					Net	Ship
1	48	15 or Less	2 N.O.	2 - 4	8 (3.6)	12 (5.4)
2	125	61 - 67	1 N.C.	2 - 6		
3	125	30 - 35		1 - 3		
4	250	65 - 70		1 - 6		
5	250	65 - 70		1 - 12		
6	125	65 - 70		2 - 12		
7	125			4 - 24		

HGA14 order Code Breakdown

Molded Case Tripping Relays, 1/2 Cycle or Less (for tripping two breakers)

HGA14	**	**	
	AM		Back connected with cover
	AL		Front connected with cover
	XX		Electrical data (see Group column under Selection guide)

Selection Guide

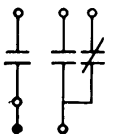
Group	DC Volt.	Pick-up Volts	Contact	For 32 A Targets	For 31 A Targets	For 30.6 A Targets	For 30.2 A Targets	For Carrier GCX or GCY	Approx. Wt. in lbs (kg)	
									Net	Ship
1	250	80% or Less		AL,AM					2 (0.9)	3 (1.4)
2	125			AL,AM						
3	48			AL,AM						
4	32			AM						
5	24			AL,AM						
6	250			AL,AM						
7	125			AL,AM						
8	48			AL,AM						
9	32			AL,AM						
10	24			AL,AM						
11	250			AL,AM						
12	125			AL,AM	AL,AM					
13	48			AM	AL,AM					
14	32			AL,AM						
15	24									
16	250				AL,AM					
17	125				AL,AM					
18	48				AL,AM					
19	32				AL,AM					
20	24				AL,AM					
25	250				AL,AM					
26	125				AL,AM					
28	48				AL,AM					
29	24				AL					

HGA14 Order Code Breakdown

Low Pickup (40% of rating for AC or 30% of rating for DC)

HGA14	*	**	*	
A				Surface mounted back connected with studs and solid cover
AF				Surface mounted front connected with solid cover
	XX			Electrical data (see Group column under Selection guide)
				Mounting options
			F	Semi-flush mounted back connected with studs and cover with glass window
			G	Cover with glass window is required

Selection Guide

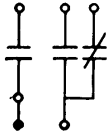
Group	DC Volt.	AC 50 Hz	AC 60 Hz	Contact	Pickup Time (cycles)	DC Res. Ohms @ 25°C	AC Res. Ohms	Approx. Wt. in lbs (kg)				
								Net	Ship			
51	250			2 N.O. 2 N.C. 	Approx 1	15500		2 (0.9)	3 (1.4)			
52	125					3650						
53	62.5					830						
54	48					512						
55	32					250						
56	24					160						
57	12					40						
58	6					10						
59	220					9600						
60	110					2460						
70			115								1000	
71			230								3960	
74		115					Approx 2				830	
75		230									4270	

HGA17 Order Code Breakdown

Time Delay, Fixed Time (15 cycles dropout) (copper slugged coil)

HGA17	*	**	*	
A				Surface mounted back connected with studs and solid cover
C				Front connected with solid cover (NO STUDS)
H				Surface mounted back connected with studs and solid cover
	XX			Electrical data (see Group column under Selection guide)
				Mounting options
			F	Semi-flush mounted back connected with studs and cover with glass window
			G	Cover with glass window is required

Selection Guide

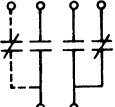
Group	DC Volt.	AC 50/60 Hz	Contact	Pickup Time (cycles)	DC Res. Ohms @ 25°C	AC Res. Ohms	Approx. Wt. in lbs (kg)	
							Net	Ship
51	250		2 N.O. 2 N.C. 	Approx 2	10300		2 (0.9)	3 (1.4)
52	125				2280			
53	62.5				585			
54	48				375			
55	32				153			
56	24				98			
57	12				24.5			
68	220				10300			
70	110				1700			
63		115			1700			
64		230			1700			

HGA17 order Code breakdown

Fixed Time Pickup with Approx. 15-cycle Delay on Dropout

HGA17	*	*	*
	D		
	H		
		XX	
			Front connected with solid cover (NO STUDS)
			Surface mounted back connected with studs and solid cover
			Electrical data (see Group column under Selection guide)
			Mounting options
		F	Semi-flush mounted back connected with studs and cover with glass window
		G	Cover with glass window is required

Selection Guide

Group	DC Volt.	AC 50/60 Hz	Contact	Pickup Time (cycles)	Pickup Volts	DC Res. Ohms @ 25°C	AC Res. Ohms	Approx. Wt. in lbs (kg)	
								Net	Ship
51	250					10300			
52	125					2280			
53	62.5					585			
54	48		2 N.O.			375			
55	32		2 N.C			153			
56	24			Approx 3.5	60%	98		2 (0.9)	3 (1.4)
57	12					24.5			
68	220					10300			
70	110					1700			
63		115				1700			
64		230			80%	1700			

