



HVDC VALVES

Power Electronics for
HVDC Schemes

ge.com/grid

TODAY'S ENVIRONMENT

Transmission grids connect our world and enable our modern ways of life... they are vital to commerce and economic growth globally. The challenges for the electrical grid are to remain operational at high reliability rates, while at the same time being adaptive, flexible and expansive in order to support the world's move toward greener generation.

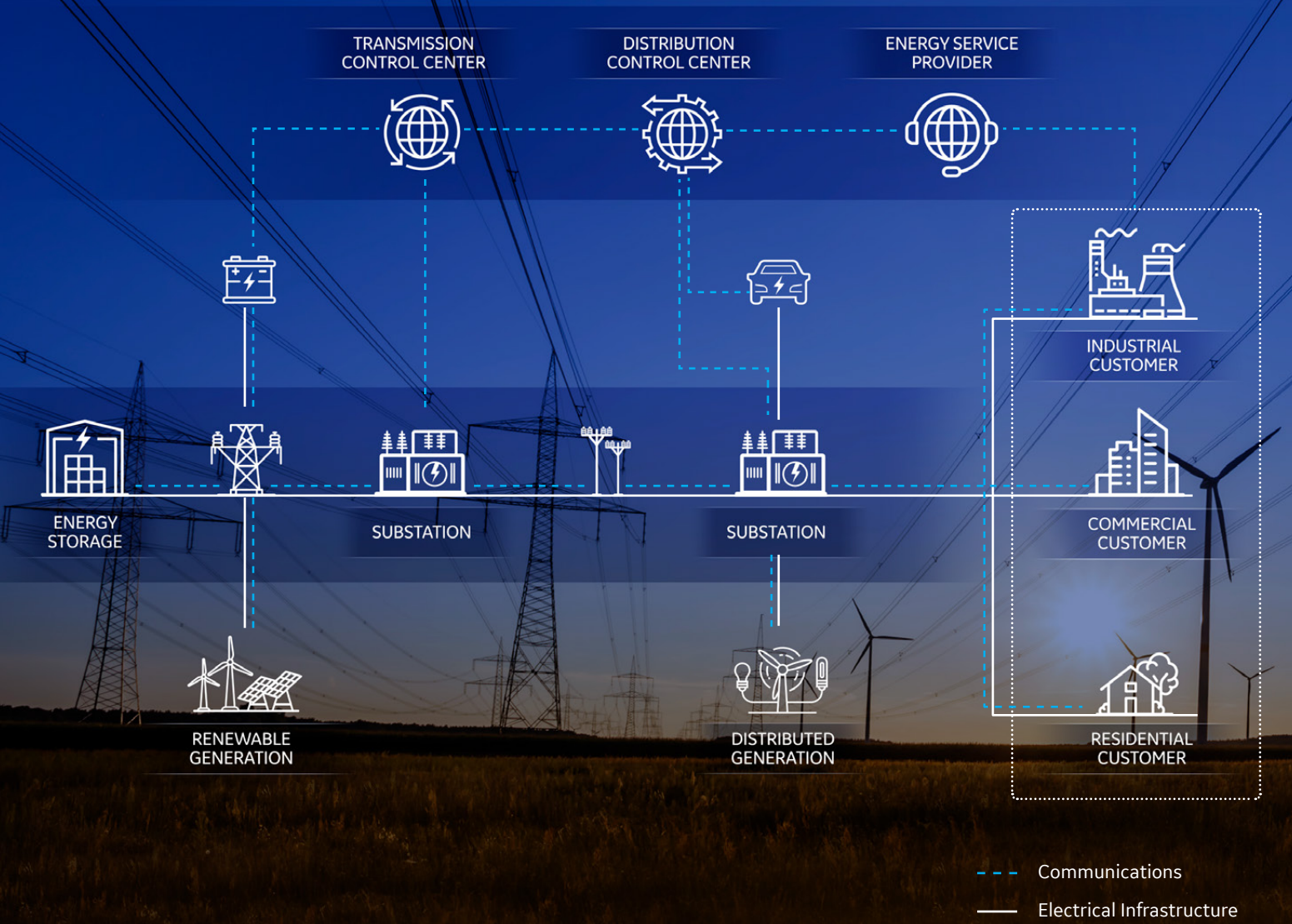



ESTIMATED OVER 25% INCREASE IN TOTAL GLOBAL DEMAND FOR ELECTRICITY BY 2040*

THE SHARE OF GENERATION FROM RENEWABLES RISES FROM 25% TODAY TO AROUND 40% IN 2040

STRINGENT POWER QUALITY, SAFETY, AND SECURITY REQUIREMENTS FROM REGULATORY AUTHORITIES

INCREASED FREQUENCY AND INTENSITY OF WEATHER EVENTS, CYBER AND PHYSICAL ATTACKS

These challenges can make power flow more complex for network operators to manage, particularly stability issues under fault clearing and post-fault conditions. These issues, as well as additional issues such as aging infrastructure, harmonics, unbalanced loads and power oscillations will impact power quality levels on the grid and power transfer capability.

High Voltage Direct Current (HVDC) technology is one of the key solutions utilities are investing in to address these modern grid challenges. At the heart of any HVDC link are the valves.

The more established valve technology is the Line Commutated Converter (LCC) using thyristors as their semiconductors. This type of valve is more suited for the bulk power transfer of electricity while achieving very low loss levels.

A more recent valve technology, introduced in the 1990s is the Voltage Source Converter (VSC) using Insulated Gate Bipolar Transistors (IGBTs). This type of valve is more suited for the connection to the grid of new renewable assets such as wind and solar farms.

TWO DISTINCT HVDC VALVE TECHNOLOGIES TO MEET THE EVER CHANGING LANDSCAPE OF MODERN ELECTRICAL GRIDS

The constant evolution in semiconductor technology has enabled the valves to meet market needs for ever increasing levels of transmitted power. Efficiency of the valves has also improved with the continuous reduction in semiconductors losses. When combined with the higher efficiency of the HVDC transmission lines over its AC equivalent, HVDC is in most cases the most cost-competitive solution for power transfer over long distance.

HVDC can also be used to connect different AC networks. As a result, resilience of the two AC grids is improved through the controlled HVDC power flow to support either AC network in case of disturbance. At the same time, the HVDC can act as a protective segregation between the two AC networks, preventing a power system collapse in one network from affecting the other one.

Modern valves benefit from increased reliability, availability and maintainability (RAM) figures. This is achieved through:

- Robust, multi-layer protection functions to increase ruggedness of the valves
- Embedded redundancy levels allowing continuity of operation at full capacity
- Easy maintenance procedure leading to low repair time
- Digital modelling of the valves coupled with intuitive HMI interface for rapid diagnostic & repair
- Completion of exhaustive system level DFMEA of valves and its environment
- Continuously integrating lessons learnt from site to improve valve design

GESOLUTION

Voltage Source Converter (VSC)

UTILIZING CUTTING-EDGE TECHNOLOGICAL ADVANCEMENTS, GE HAS DEVELOPED ITS MOST ADVANCED MAXSINE VALVE SPECIFICALLY TO ADDRESS THE COMPLEX CHALLENGES OF THE GRID.

MaxSine™, GE's Most Advanced HVDC Valve

MaxSine is a Modular Multi-Level Converter (MMC) consisting of multiple submodules connected in series to form a "chain-circuit". With this topology, quasi-sinusoidal voltage waveforms can be created and no filter is required for connection to the grid. This is a strong departure from LCC technology leading to a more compact station layout. This is of particular importance for segments of the market where space is at a premium such as offshore projects or city infeed applications. The capabilities of the VSC topology also permit for fast and independent active and reactive power control and multi-terminal schemes.

The preferred submodule choice for most applications is the half-bridge submodule as it offers lower cost and lower losses compared to the full-bridge equivalent. Each submodule consists of a combination of IGBTs and diodes, DC capacitor, bleed and rapid discharge resistors,

bypass switch along with the control electronics and protection circuits. The submodules are installed in a valve module. The module provides to its submodules all the necessary ancillary functions such as mechanical support, water cooling, electrical connections and fibre optic communications.

Each submodule and module are assembled and fully tested at our modern production line in Stafford, UK. At site, the valve modules are then integrated into a final valve structure, that provides insulation, electrical connections between power modules and a supply of coolant. Communication from and to each submodule is carried in the Passive Optical Network (PON) used in HVDC MaxSine.

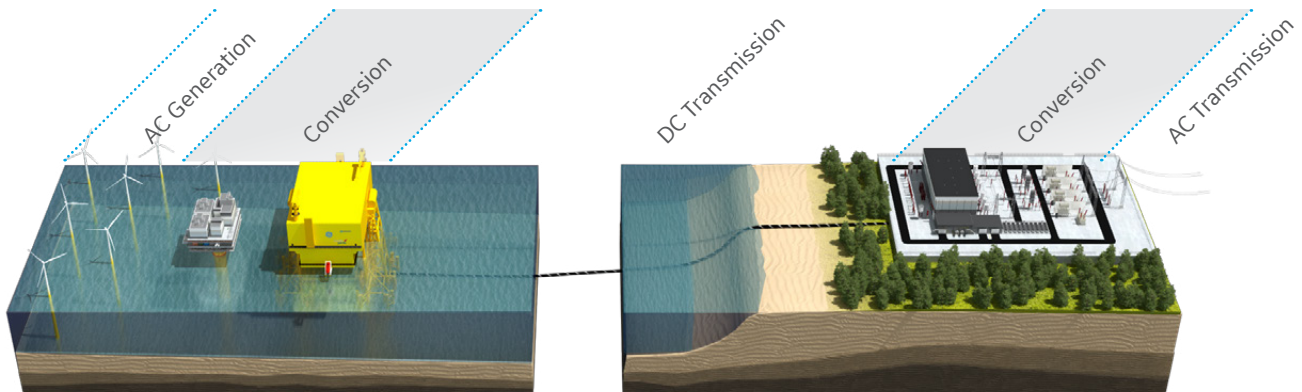

GESOLUTION

Line Commutated Converter (LCC)

GE CONTINUES TO INNOVATE IN LCC TECHNOLOGY TO PROVIDE OUR CUSTOMERS WITH OUR MOST COMPETITIVE LCC OFFER TO DATE.

H450, The Latest Generation of Thyristor-Based HVDC Valves

The H450 is the latest and most advanced HVDC thyristor-based valve that is used in both new and retrofit Line Commutated Converter (LCC) applications. GE has a very strong pedigree in thyristor based valve technology, dating all the way back to the 1950s when GE invented the thyristor device. GE in fact installed the world's first thyristor-based HVDC scheme at Eel River in Canada in 1972.

Today, thyristor-based technology is considered robust and well-proven in the industry. LCC is the technology of choice for bulk power transfer thanks to the very high efficiency and capacity of the thyristors used in LCC valves. The H450 valves can carry currents of up to 5kA DC and operate at voltage levels of up to 800kV DC.

Reliability, Availability and Maintainability (RAM) figures are extremely good thanks to the ruggedness of the thyristors as well as the 60+ years of experience that GE has gained since introducing this power electronics device to the industry. The design of the H450 valve also incorporates the vast experience GE has accumulated as a pioneer of LCC technology.

GE has installed nearly 50 projects globally that have used thyristor-based valves, accounting for more than 1,400 valves that have been placed into service.

GE's LCC valve design has proven to be quite robust as well as very adaptable for specialized applications of the technology. Included here are some examples of the unique and specialized applications that our valve design is currently operating:

- Our LCC valve technology currently enables one of the longest overhead line HVDC links in the world. Each bipole of the Rio Madeira project in Brazil spans over 2,375 kilometers and transmits 3,150MW at ± 600 kV DC
- The Cross-Channel link between the UK and France is currently the most highly utilized and highest rated power submarine DC connection in the world, with eight parallel 270kV cables
- The Lévis De-icer is the world's first HVDC-based combination of a de-icing system and voltage controller. Using two HVDC converters connected in parallel the system provides a controlled DC current of up to 7,920A for AC line de-icing

The MaxSine™ Valve for VSC Applications

The Modular Multi-Level Converter

The market has recognized the advantages of the VSC technology opening new applications – particularly integration of renewables and AC network support. Hence, the development of the half-bridge, Modular Multi-Level Converter (MMC) VSC, which has now become almost a standard for the industry.

An MMC converter uses a number of discrete voltage levels to synthesize an AC waveform. Used in HVDC, six valves are arranged in a bridge configuration to form one complete 3-phase converter.

Each valve consists of a number of series connected submodules, which individually act as controllable voltage levels. With a sufficient number of submodules per valve, a quasi-sinusoidal output voltage waveform is created. It is therefore possible to achieve low or negligible harmonic distortion, so that large AC passive filters (and the premium space they demand within the footprint) are not required to ensure compliance with grid codes.

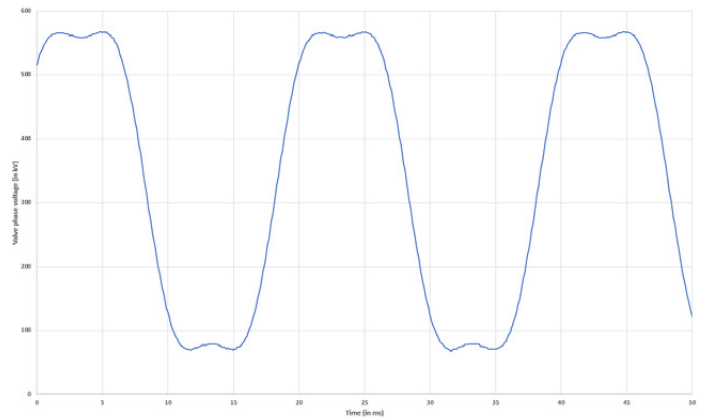

Measured valve phase voltage from DolWin 3 showing fundamental waveform with 3rd harmonic injection

Through the seamless integration of GE's VSC valves with our new industry leading eLumina™ control system, high availability power transfer is made possible for Grid Operators. Key considerations are also made as part of our turnkey offer to optimize the integration of the valves with its supportive auxiliary circuits like the cooling plant, HVAC and reactors. The best design will look at identifying the most optimum point for competing parameters like cost, size and losses.

HVDC MaxSine is also equipped with key protection features. Coordinated by a hierarchical protection strategy, these features ensure that the VSC valves achieve a high level of resilience/ ruggedness when faced with system level faults.

“OUR LATEST ITERATION OF THE MAXSINE VALVE BUILDS ON THE EXPERIENCE OF THE FIRST-GENERATION VALVE BUT ACHIEVES IMPROVED POWER HANDLING CAPABILITY, FOOTPRINT AND LOSSES THROUGH USING THE LATEST GENERATION OF IGBTs.”

Colin Davidson, Consulting Engineer, GE's Grid Solutions Business

GE'S MOST OPTIMIZED VALVE FOR SEAMLESS INTEGRATION OF NEW RENEWABLE ENERGY SOURCES

Fully Scalable Modular Multi-Level VSC valve

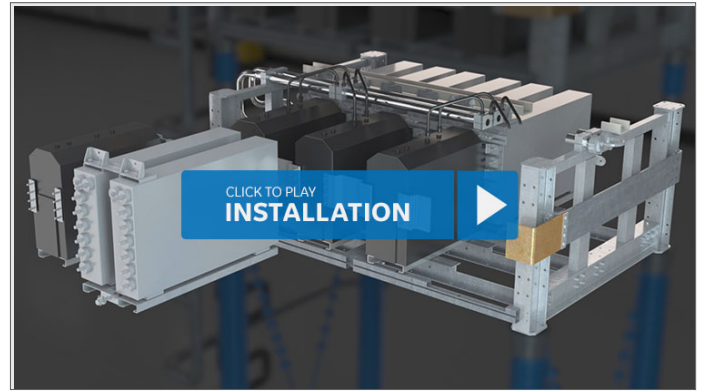
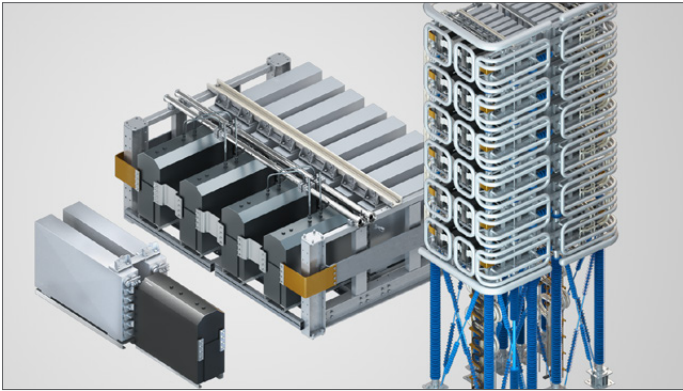

Key features

- Half-bridge submodules in a chain link MMC
- Technology currently deployed on 3 VSC projects (3.5GW) including the DolWin 3 offshore wind grid interconnection
- Optimization of valve hall size through flexible valve layout
- Established supply chain and proven production facility
- Easy maintenance through detachable power electronics block
- Designed, manufactured and type tested based on the latest IEC Standards
- Fully in-line with environmental regulations during manufacturing, installation, maintenance as well as converter's end of life and component recycling

Benefits to our customers

The latest MaxSine™ valve incorporates all the lessons learnt from the VSC projects GE has built.

In particular, the valve structure has been re-engineered to offer more flexibility with regards to the valve hall layout. When combined with an exhaustive test campaign that has improved the valve dielectric characteristics, the overall valve hall size can be markedly reduced.

Furthermore, maintainability of the submodules has been significantly simplified. Earthing of the valves and discharging of the capacitors can be done rapidly thanks to the offsetting of the DC capacitor terminals. The power electronics block of each submodule is now easily detachable from the DC capacitor. As a consequence, the volume and weight of the serviceable part is more than halved. These two key modifications reduce the maintenance time leading to increased system availability.

Each submodule benefits from multi-layered coordinated protection. In the case of overvoltage following a fault in the system, a local rapid discharge circuit can control a rise in the DC voltage in each submodule and therefore maintain during this event the full performance and controllability of the HVDC link. A dedicated bypass thyristor also protects the diode D2 from an overcurrent during a DC-DC fault. Finally, the bypass switch will bypass the submodule in the unlikely case of an unrecoverable fault emerging inside the submodule. This action will prevent any disruption at system level and ensures that continuity of operation can be achieved.

TECHNICAL DATASHEET	
Converter type	Modular Multi-Level
Connection	B2B or PtP
Arrangement	Monopole, Symmetrical Monopole, Bipole
Power rating	2.1GW at ±25kV DC 1.3GW at ±320kV DC
Semiconductor	IGBT power modules
Type tests	Fully compliant with latest edition of IEC 62501

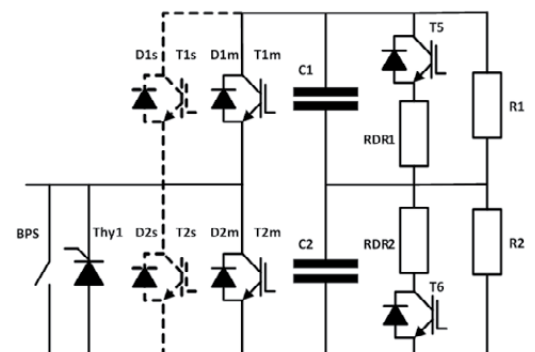

Simplified Circuit Diagram of Valve Submodule

The H450 Valve for LCC Applications

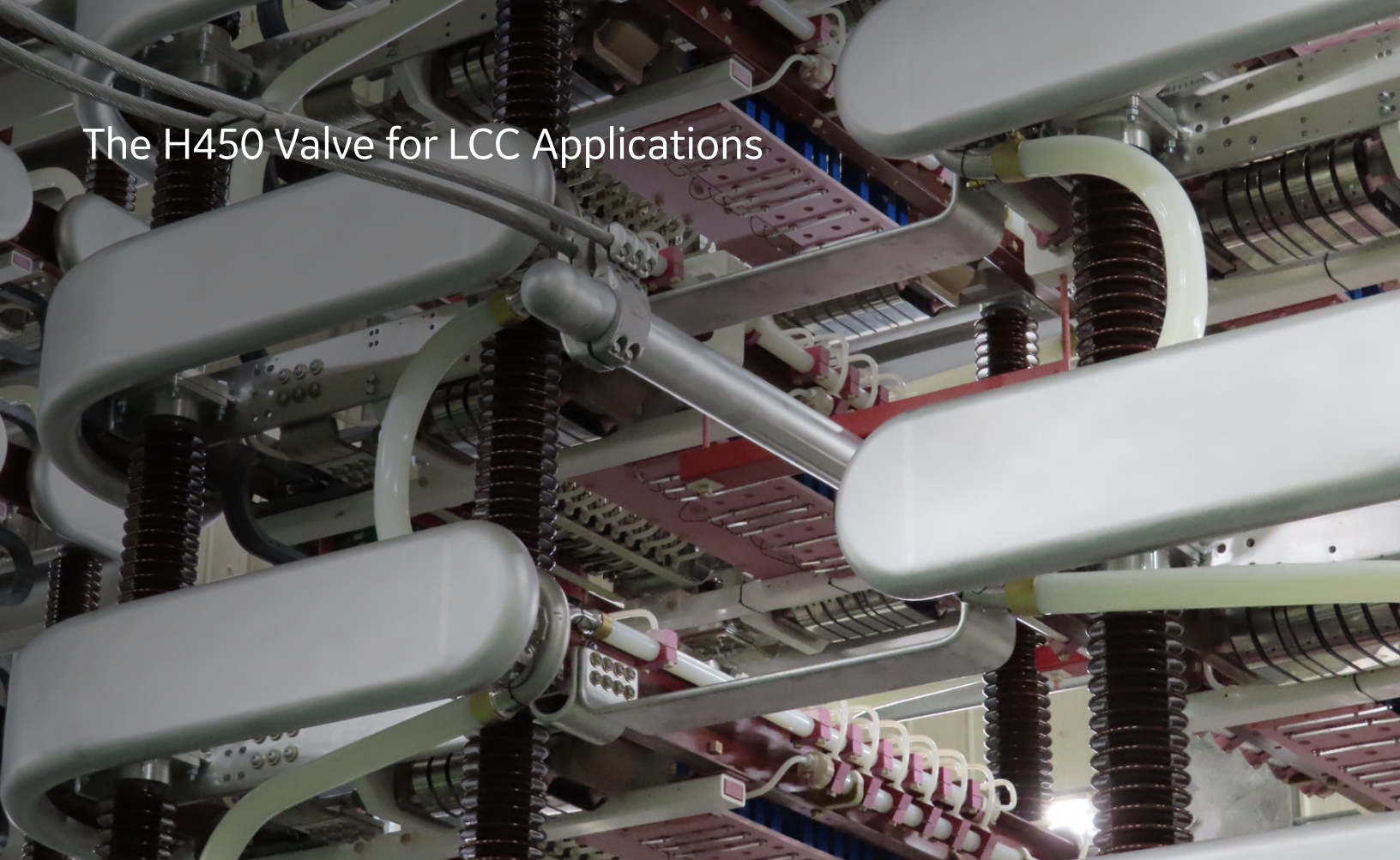

Overview

With our latest H450 valve modules, GE demonstrates a continuous commitment to invest in LCC technology with the intent to provide our customers with a more compact and adaptable solution that can satisfy existing and emerging market needs.

The valves are a part of a conventional Line Commutated Converter. The H450 modules use electrically triggered thyristors with a voltage rating of 8.5kV and a silicon diameter of up to 150mm (6 inches).

The modules are installed together to form part of a Multi-Valve Unit (MVU). As a result, power rating of up to 8GW at ± 800 kV for the LCC converters can be achieved.

GE's most compact LCC valve to date

GE continues to invest in LCC technology in order to further optimize the size and footprint of the valve itself and the surrounding valve hall.

Indeed, the H450 module benefits from a 40% reduction in size when compared to the previous generation of LCC valve. In addition, following an extensive U_{50} test campaign to determine the precise electrical signature of the LCC valves, the electrical clearance distances have been reduced.

The positive combination of a more compact valve and reduced air clearances leads to a valve hall that is up to 30% smaller.

“WHILE THE H450 THYRISTOR-BASED VALVE HAS RETAINED THE ROBUSTNESS AND WELL PROVEN ELECTRICAL DESIGN AND MAIN COMPONENTS FROM ITS PREDECESSOR, IT HAS ALSO INTRODUCED A NUMBER OF MAJOR IMPROVEMENTS INCLUDING REDUCTION OF FOOTPRINT, WEIGHT AND ELECTRICAL CLEARANCE, AND AS A RESULT, IT ALSO HELPS THE VALVE HALL FOOTPRINT REDUCTION, MANUFACTURABILITY, AND MAINTAINABILITY”.

Tianning Xu, Senior Engineering Valve Manager, GE's Grid Solution Business

Thyristor clamp assembly

The H450 module is designed to accommodate 4", 5" or 6" thyristors. The thyristors are mounted into a thyristor clamp assembly (TCA) and cooled with a de-ionised water and glycol mix. Both mono-ethylene glycol or the more environmentally friendly propylene glycol can be used.

Valve electronics

A Thyristor Control Unit (TCU) adjacent to its dedicated thyristor provides overall control and protection with the following functionalities:

- Turns the thyristor on when commanded by the control system
- Autonomously turns the thyristor on to protect against excessive forward voltage, dv/dt or forward recovery failure
- Fault monitoring ("databack")

The communication between the Valve Base Electronics (VBE) control and the valve electronics at the individual thyristor level are carried out by means of optical fibres, one for firing data and the other for data back.

Auxiliary circuits

Electrical auxiliary circuits provide protection and ensure optimal performance for the thyristors.

The auxiliary components include two di/dt reactors, located on each side of the TCA. The functions of the di/dt reactors are:

- Limit di/dt during the early stages of the thyristor turn-on process
- Protect the thyristors by providing sufficient damping to prevent the oscillatory inrush current from reaching zero
- Protect the thyristors during the impulse voltage conditions

In addition, an RC damping circuit is fitted to protect the thyristors from the oscillatory transients which occurs at turn off.

Finally, a DC grading resistor is fitted across each thyristor for voltage grading in the TCA when the valve is blocked. This is especially important when the applied voltage contains a DC component.

Multi-Valve Unit

Adaptable arrangement offering flexibility of integration.

The Multi-Valve Unit is available as a square or an in-line arrangement. This choice offers flexibility for the installation of the valves into the valve hall to match different plot sizes and shapes.

They are traditionally suspended, but a ground mounted solution is also possible. For the KEPCO BP1 retrofit project in the Republic of Korea, H450 modules were ground-mounted to accommodate the limited space available from the replacement of existing ground-mounted valves.

With a more compact H450 module, accessibility to the serviceable parts of the module is made easier.

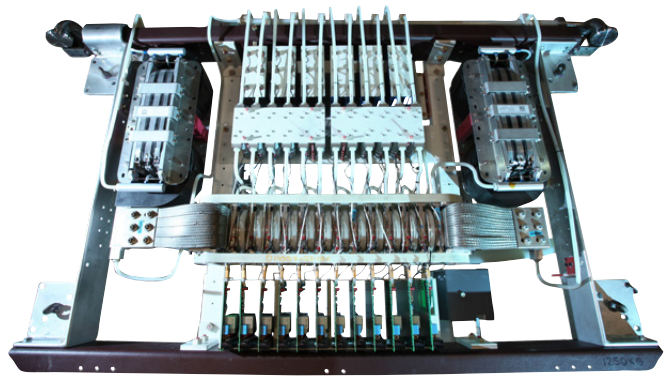

H450 Valve Module

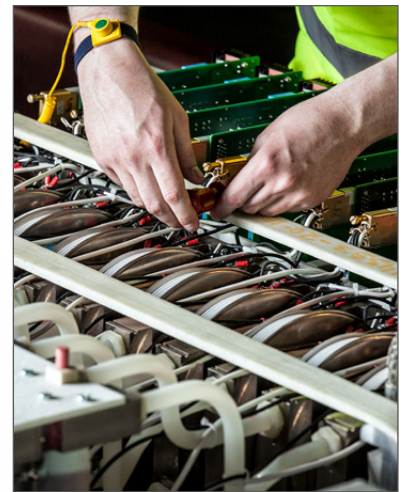
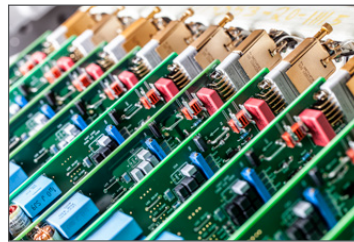

In-line Arrangement



Square Arrangement

GE HVDC Valve Test Facility



GE has a long history in developing what ultimately became adopted by the industry as the premier method of testing HVDC valves. In 2019, GE has again set a new standard in both LCC and VSC valve testing with the introduction of the state-of-the-art Valve Test Facility in Stafford, UK

Testing of HVDC Valves

Type tests for HVDC valves are defined in IEC 60700-1 (for LCC valves) and IEC 62501 (for VSC valves). These standards define several categories of testing; however, the most challenging category of test is the “operational tests” that demonstrate the ability of the valve to withstand the repetitive voltage and current stresses occurring alternately during normal operation. With currents of several kiloamperes and off-state voltages of hundreds of kilovolts for the valve as a whole, such circuits are challenging to design and build without requiring very powerful test supplies.

Limitations of Existing Test Methods

For LCC valves, CIGRÉ identified two principal types of test circuit suitable for

testing: those based on a back-to-back six-pulse (or three-pulse) test circuit and those based on a synthetic test circuit, which GE (from its predecessor company English Electric) pioneered in the 1960s.

Back-to-back test circuits suffered from two inherent limitations: firstly the difficulty in obtaining high power ratings and secondly their dependence on the frequency of the AC network to which they were connected. In addition, because the current and voltage waveforms depend on the impedance of the transformer and the coupling between star and delta bridges, it is not possible to obtain perfect voltage and current waveforms without using a custom-designed transformer for each project, an approach which is clearly very costly.

Synthetic test circuits provided a way of overcoming the limitations of the back-to-back test circuit and allowing much larger (and more representative) sections of valve to be tested in a single stage. Synthetic test circuits were initially viewed with skepticism in the industry but over the intervening years they have become accepted as the standard method for performing operational tests. Over the years, GE and its predecessors in Stafford, UK, have progressively refined the synthetic test circuit.

The principal disadvantage of synthetic test circuits in their current form is that the voltage and current waveforms do not look visually similar to those of a real HVDC converter. Although a well-designed synthetic test circuit is able to reproduce all the key parameters required by the standards, it can never achieve perfect waveform fidelity.

Several test circuits have been proposed for performing the operational type tests on VSC valves. All generally involve dividing the test object into several sections, typically two or four, in a back-to-back or bridge arrangement and operating them together with a load inductor. This method is capable of allowing the valve voltage and current to be controlled independently and meets all the objectives defined in IEC 62501. However, a limitation exists in that the valve sections under test are effectively being used to drive current through an inductive load. As a consequence, the phase relationship between valve voltage and valve current cannot be changed with this approach.

For the above reasons, GE has invested in a new state-of-the-art HVDC Valve Test Facility in Stafford, UK, which employs a novel and fundamentally different approach to testing HVDC Valves.

GE introduces a new and novel approach to HVDC valve testing, utilizing full-bridge MMC valves at the heart of the solution.

Introduction to the New Test Facility

The MMC topology has transformed the HVDC industry, allowing the flexibility of VSC to be achieved with power ratings and efficiency that are now starting to challenge those of LCC technology. Accordingly, when the need was identified to build a new, purpose-built HVDC Valve Test Facility (VTF), it was fitting that MMC valves should be at the heart of the new test circuit.

The new VTF makes use of the fact that MMC valves are effectively “controllable voltage sources”. It therefore stands to reason that if a sufficiently large and powerful MMC valve is used (and provided with a source of energy to make up the losses in the circuit) then it can be used as a current or voltage “arbitrary waveform generator” and take the place of both the high-current and high-voltage parts of the older synthetic test circuit. This allows the test circuit to be made considerably simpler than the classic synthetic test circuit.

The programmable waveform generator is constructed from four series arrays of Full-Bridge MMC submodules, with 48 submodules in each array. By using this number of submodules, the test circuit is capable of producing a repetitive test voltage far in excess of what is required by the International Standards, with a test current in LCC mode of up to 6000A.

In series with each of the four arrays of Full-bridge submodules is a multiple-tapped reactor, which allows the effective commutating reactance for the project to be adjusted to accurately represent the conditions for the valve under test. This is particularly important for testing LCC valves.

The circuit also includes an impulse generator which can be used to apply carefully-timed impulses of various different front-times to the valve during the recovery interval, which is an essential requirement of the type tests for an LCC valve operated under inverter conditions. For the slower front times, such as 100µs, the Full-Bridge valves of the main operational test circuit can be used as the impulse generator.

In addition, provisions are made to perform the IGBT turn-off tests and diode overcurrent tests required for the testing of VSC valves.

GE has now built a new, purpose-built test facility which allows the testing of HVDC valves to be taken to new levels of waveform fidelity. The test plant is located in Stafford, UK, near GE’s HVDC Centre of Excellence and is capable of testing both LCC and VSC valves to voltage and current levels higher than are required today or in the foreseeable future.

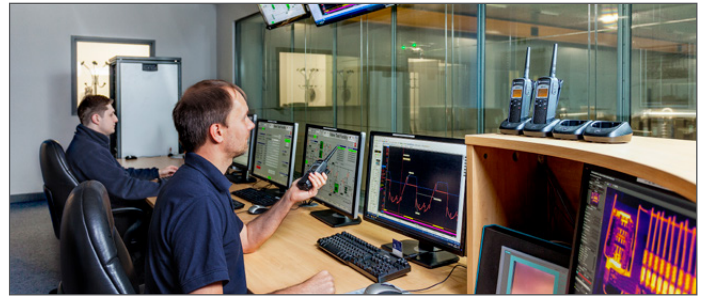

Valve Test Facility Control Room

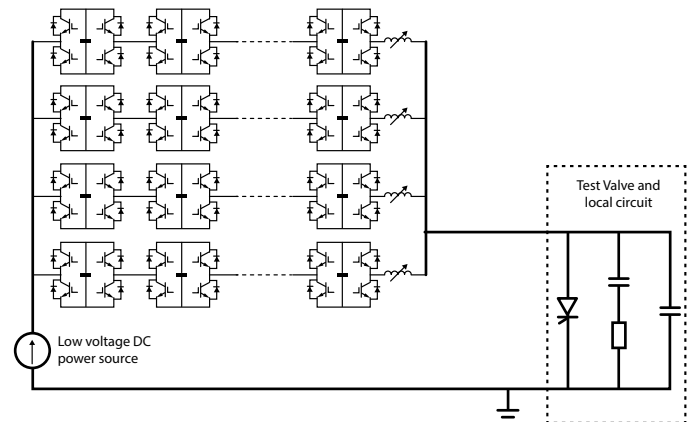

Simplified circuit diagram of the Valve Test Facility

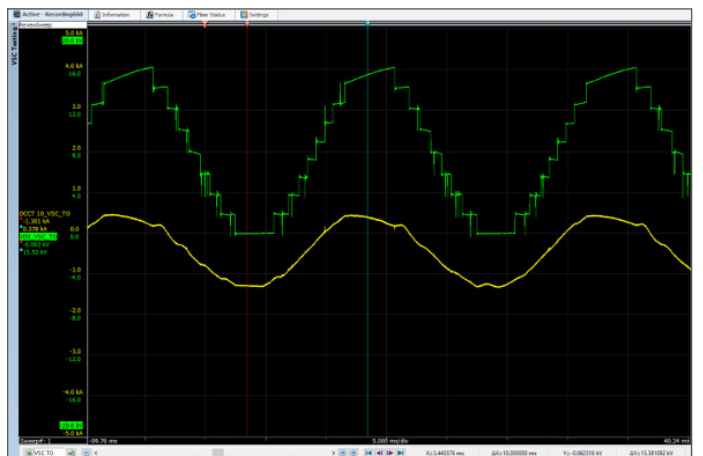
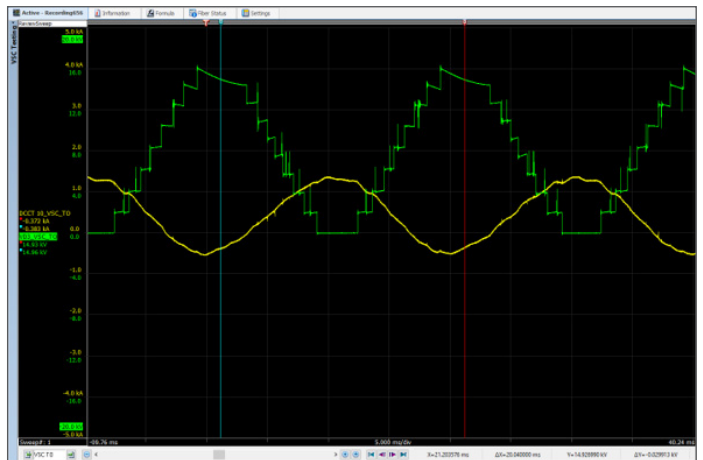

Testing VSC valves: Voltage across (green) and current through (yellow) the test object, for inverter mode (top) and rectifier mode (bottom)

Valve Base Electronics

Interfacing the converter control system to the individual power electronics modules within the HVDC power converter

For our VSC converters, the Valve Base Electronics (VBE) system communicates with the power electronics modules using an industry standard passive optical communication technology which allows each module to be controlled and monitored in a tightly-synchronized, time-critical and reliable manner while minimizing the number of fibers needed without compromising redundancy.

Advantages of Valve Base Electronics

- Low fiber count makes it much easier to install and maintain than traditionally used point to point systems
- Provides a very fast update rate and low overhead communication
- Provides the electrical isolation required to communicate between ground level control systems and high voltage valves, up to 800kV

Performance Optimization and Predictive Maintenance

The optical communication system provides essential operational and valuable diagnostic data to be collected from every submodule, enabling performance optimization and predictive maintenance. Data includes: submodule status, communication light level, serial numbers, firmware version numbers, physical location of the submodule within the valve hall, detailed failure codes, transceiver temperatures.



VBE Function

Line Commutated Converter (LCC) Systems

In LCC systems the phase control defines the instantaneous point-on-wave firing angle which applies to the whole converter. This is then passed down to valve control, which converts it into a switching sequence for each of the valves in the 12-pulse converter.

This valve sequence is passed down to VBE, which then distributes individual signals to turn on each of the thyristors in the valves at the appropriate time.

Voltage Source Converter (VSC) Systems

In VSC converters, the switching commands for the Insulated Gate Bipolar Transistor (IGBT) valves are selected in such a way as to simultaneously balance the individual submodule capacitor voltages, and to define the submodule switching instant and thereby create the phase and amplitude of the synthetic waveform.

The valve control functionality provides the submodule capacitor voltage to the phase controls via a fast optical link. This value is used by the control algorithms to:

- i. manage power flow into and out of the convertor
- ii. maintain the capacitor voltages at their target values

Status Information

Status information from every valve submodule or thyristor level is collated by the VBE system in the form of databack information.

This databack information includes the submodule status information in the case of VSC converters, and thyristor level status information in the case of LCC systems, which is required by the higher levels of the HVDC control and protection systems.

This databack information contains specific and summary data of the converter status, and is transmitted through multiplexed, full duplex, and redundant optical fiber links to the HVDC control and protection systems.

This mechanism is used, for example, to report the present valve redundancy levels to the operator workstation and to provide the “converter valve ready for service” information to the HVDC control system’s start-up interlocks and sequencing functions.

**LINE COMMUTATED CONVERTER (LCC)
VALVE HALL**

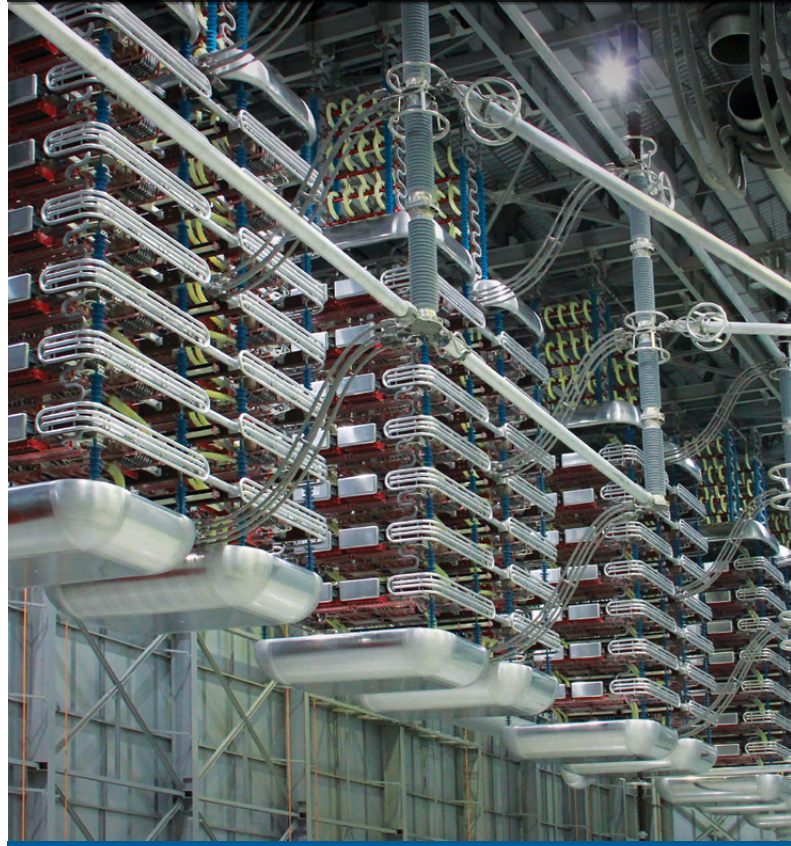

**VOLTAGE SOURCE CONVERTER (VSC)
VALVE HALL**



GE's New HVDC Center of Excellence



GE continues to invest in grid integration technology, including a new state-of-the-art office space in Stafford, UK, which is the home of GE's Center of Excellence (COE) for HVDC technology

World Class Office Space

- Co-located work environment for over 500 employees
- R&D, Engineering, Projects and Commercial teams collaborating for best customer outcomes
- State-of-the-art video links to HVDC centers of excellence in India and Korea

Significant Investment in Testing and Simulation Systems

GE is implementing a Model-Based Design approach to control software for HVDC projects. Quantifiable process improvements, such as testing and design iterations have been reduced by as much as 75%, with corresponding design documentation being available almost immediately.

Advantages of GE's Design Approach include:

- Rapid configuration of control and protection functions
- Rapid integration with power system simulation software
- Accelerated testing and verification
- Automatic code generation and deployment

Testing and validation of this design approach on project implementations is also supported through the significant investment in contract system validation systems:

- Multi-project test capacity, >45 RTDS™ racks
- Multiple fully equipped customer FAT test suites



GE HVDC Valve Assembly and Test Operations

New Product Introduction (NPI) and Design for Assembly and Test Process

The assembly and testing operations play a key role in the NPI process, ensuring that all new designs incorporate lessons learned for a robust and error free production process. Manufacturing are fully involved from early initial concepts through to product launch. Industrialization drives the strategy and planning which include Design for Manufacture and Design for Test within the development process. Integrating the manufacturing requirement into the design ensures a quality product can be manufactured every time in the desired timescales without complex process requirements. During product launch manufacturing lines and processes are set up using GE methodologies, including Lean principles, to ensure efficient, repeatable and reliable processes for assembly and test. Continuous improvement activities are ongoing to make sure we meet and exceed the demands of the future.

High Capacity VSC and LCC Valve Manufacturing Facility

Dedicated assembly and testing lines for both VSC and LCC valves enable GE to provide customers with unparalleled quality and cycle time. GE's manufacturing processes and tools have been designed to be applied as a "flow" production line, from initial assembly to final product testing. This results in increased quality, decreased cycle times and improved safety. The tools and layout of the production line have been implemented with ergonomics in mind. All equipment and tools used within the line are to ease the handling of component pieces and the finished product, thus reducing the strain on assembly operators. The intelligent manufacturing software allows operators to view all work related instructions as well as systemically apply the correct torque settings in the right sequence, eliminating the possibility of operational errors. This system also allows full traceability of both build and test results down to component level. Production systems are in place to ensure that no product can leave the factory unless it has met all of the quality and testing standards required. The testing of the valve is done in full compliance with the latest iterations of the IEC standards. This test equipment has been designed and developed to perform functional tests that are applied to every project to confirm 100% adherence to electrical, mechanical and cooling requirements.

Supporting GE's Business Objective of Being Carbon Neutral by the end of 2020

One of the things that is immediately obvious when you walk through the manufacturing facility is the attention paid to lowering the carbon footprint of the operation. From the use of natural lighting to re-usable packaging and minimizing the transport footprint, great lengths have been taken to ensure that our operations are sustainable per today's standards and expectations.

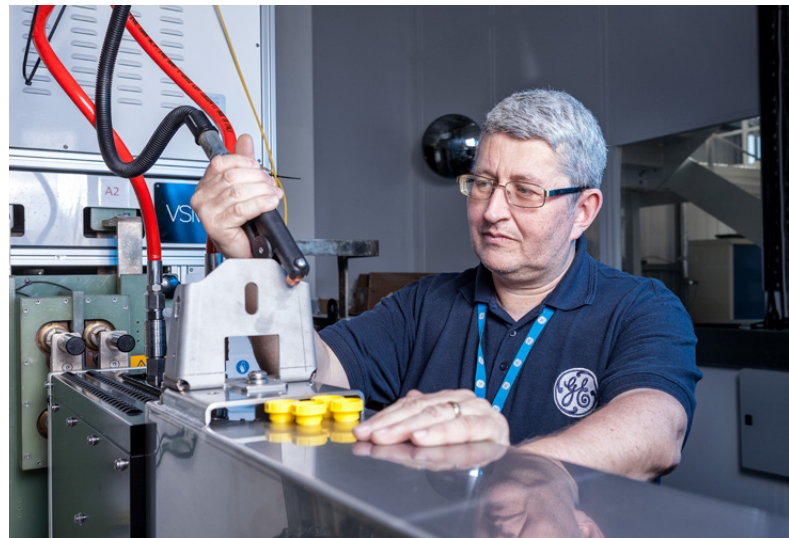



For more information about
GE's HVDC Power Electronics Valves, visit
www.GEGridSolutions.com/HVDC

GE reserves the right to make changes to specifications of products described at any time without notice and without obligation to notify any person of such changes.

Copyright 2019, General Electric Company. All Rights Reserved.

GEA-33142-(E)
English
200221